

NIGHT SYSTEMS

Poliform

Poliform

Poliform è una delle realtà più significative nel mondo dell'arredamento internazionale per qualità del design, eccellenza del progetto e innovazione. Il suo talento è il saper fare, una capacità che unisce cultura e conoscenza e che prima di essere un gesto, il gesto che rende riconoscibile tutto ciò che è firmato Poliform, è un'idea di progettazione. Un pensiero che unisce ricerca di funzionalità, contenuti espressivi e significati, e che della combinazione tra estetica e utilità ha saputo fare un'arte, in ogni area della casa. Nella zona notte, quest'arte si esprime attraverso sistemi dal design eccellente, che rispondono alle esigenze delle persone e ne appagano i sensi, giorno dopo giorno.

Poliform is one of the most important companies in the world of international furniture for design quality, project excellence, and innovation. Its talent is the know-how, a skill that unites culture and knowledge and that, before being a gesture, the gesture that makes everything signed Poliform recognizable, it is a design idea. A thought that combines research of functionality, expressive contents, and meanings, and that has been able to make an art of the combination of aesthetics and utility, in every area of the house. In the night area, this art is expressed through systems with excellent design, which meet people's needs and satisfy their senses, day after day.



ART OF THE NIGHT SYSTEM

Armadi e cabine armadio sono gli spazi cui affidiamo i nostri abiti. Progettati in modo funzionale e realizzati con materiali selezionati, accolgono qualsiasi tipologia di capo con accessori dedicati.

Wardrobes and walk-in closets are the spaces to which we entrust our clothes. Designed functionally and made with selected materials, they accommodate any type of garment with dedicated accessories.





Contenitore per eccellenza, l'armadio si compone di tanti moduli di diverse dimensioni. Al suo interno ogni capo ha una destinazione ideale – appeso o ripiegato su un ripiano o dentro un cassetto.

Container par excellence, the wardrobe is made up of many modules of different sizes. Inside, each garment has an ideal destination – hung or folded on a shelf or inside a drawer.

Riporre è un'azione semplice e universale, un gesto che ha l'obiettivo di riportare l'ordine non solo nella zona notte, ma in ogni spazio della casa – dall'abito appena indossato all'oggetto riposto dopo l'uso.

Placing is a simple and universal action, a gesture that aims to bring back order not only to the night area, but to any space in the house – from the garment just worn to the object put back after use.





Si custodisce qualcosa di valore, cui si tiene in modo particolare. Si custodisce anche per poter tramandare, fermando gli effetti del passare del tempo con teche, vetrine e altre soluzioni dalla qualità eccellente.

You keep something of value, something you care about deeply. You keep also to be able to hand down, stopping the effects of the passage of time with showcases, display cabinets, and other solutions of excellent quality.

Armadi e cabine armadio sono disegnati in modo razionale. Dotati di attrezzature molteplici e specifiche, rispondono alle esigenze di chi li usa, ottimizzando lo spazio interno.

Wardrobes and walk-in closets are designed rationally. Equipped with numerous and specific pieces of equipment, they meet the needs of those who use them, optimizing interior space.





La discrezione è la peculiarità della zona notte,
l'area più intima e riservata della casa.
Armadi e cabine armadio vi si adattano: i numerosi
modelli di ante e aperture sono progettati per celare
o lasciare soltanto intravedere l'interno.

Discretion is the peculiarity of the night area,
the most intimate and confidential area of the house.
Wardrobes and walk-in closets fit in: the numerous
models of doors and openings are designed
to conceal or leave only a glimpse of the interior.

Ordinare è un modo di disporre le cose l'una accanto all'altra, di sistemare gli oggetti per creare o riportare armonia. Ogni volta che ordiniamo creiamo un nuovo equilibrio tra funzionalità ed estetica, dando un nuovo senso alla realtà.

Tidying is a way of arranging things side by side, of organizing objects to create or restore harmony. Every time we tidy, we create a new balance between functionality and aesthetics, giving a new meaning to reality.





SHOWING

Arredare è mostrare qualcosa di sé, proprio come vestirsi. Con un'ampia proposta di finiture e soluzioni ad hoc, armadi e cabine armadio diventano specchio di personalità e stile, come un abito.

Furnishing is showing something of yourself, just like dressing. With a wide range of finishes and ad hoc solutions, wardrobes and walk-in closets become a mirror of personality and style, like an outfit.

Se nella luce convivono da sempre
praticità e bellezza, nelle configurazioni speciali
come gli armadi tutto vetro la luce supera
la sua funzionalità, diventando accento estetico.

If practicality and beauty have always coexisted
in light, in the special configurations such as the
all-glass wardrobes, light exceeds its functionality,
becoming an aesthetic accent.





La qualità dell'aria è importante per il nostro benessere – anche dentro l'armadio, dove è possibile purificarla. Una piccola attenzione che migliora la qualità della vita.

The quality of the air is important for our well-being – even inside the wardrobe, where you can purify it. A little detail that improves quality of life.

Ciascuno di noi è affezionato ad alcune categorie di oggetti che ai suoi occhi assumono il fascino di una collezione. Oggetti che durano nel tempo, come gli arredi che li accolgono.

Each of us is fond of certain categories of objects that in our eyes take on the charm of a collection. Objects that last, like the furniture that welcomes them.





Il sistema più completo ed efficace per la zona notte è quello che integra tante funzioni quante sono le esigenze delle persone, in una perfetta continuità estetica tra armadio e cabina armadio.

The most complete and effective system for the night area is the one that integrates as many functions as there are people's needs, in a perfect aesthetic continuity between wardrobe and walk-in closet.

NIGHT SYSTEMS

Poliform presenta i sistemi per la zona notte, armadi, cabine e cassettiere a isola progettati per creare spazi razionali da dedicare all'ordine. Una proposta che reinterpreta l'armadio in chiave contemporanea, come contenitore universale da personalizzare con la massima libertà. Si creano così – a partire da due sistemi, due cassettiere a isola e una lunga serie di accessori e attrezzature – possibilità di composizione pressoché infinite.

Poliform presents the systems for the night area, wardrobes, walk-in closets, and island chests of drawers designed to create rational spaces to be dedicated to order. An offer that reinterprets the wardrobe with a modern approach, as a universal container to be customized with maximum freedom. This creates – starting from two systems, two island chests of drawers, and a long series of accessories and equipment – basically infinite possibilities of composition.

COLLECTIONS

SENZAFINE ARMADI SENZAFINE WARDROBES	35
INTERIOR 01 PLUS	38
INTERIOR 02 PLUS-EGO	52
INTERIOR 03 COVER	64
INTERIOR 04 FITTED	82
INTERIOR 05 BANGKOK-EGO	94
INTERIOR 06 OCEAN	104
INTERIOR 07 NEW ENTRY-FITTED	112
INTERIOR 08 NEW ENTRY-FITTED	124
INTERIOR 09 OCEAN-FITTED	138
INTERIOR 10 NEW ENTRY	148
INTERIOR 11 BANGKOK	158
INTERIOR 12 NEW ENTRY-FITTED	170
SENZAFINE CABINA ARMADIO SENZAFINE WALK-IN CLOSET	181
INTERIOR 13	184
INTERIOR 14	196
INTERIOR 15	208
UBIK CABINA ARMADIO UBIK WALK-IN CLOSET	219
INTERIOR 16	222
INTERIOR 17	234
INTERIOR 18	248
CASSETTIERE A ISOLA CHESTS OF DRAWERS	259
SENZAFINE	262
SET-UP	268
DATI TECNICI TECHNICAL DATA	275

SENZAFINE WARDROBES

Senzafine è un sistema che si arricchisce continuamente di nuove soluzioni estetiche e funzionali. La struttura modulare, la stessa dell'omonima cabina, offre la massima versatilità dimensionale e compositiva: è arricchita dai fianchi a telaio, anche in vetro, e da un'ampia collezione di ante – battenti, scorrevoli o complanari, sempre contraddistinte da linee essenziali e finiture ricercate. Cassettiere, attrezzature e accessori completano una proposta evoluta, in grado di adattarsi a ogni spazio.

Senzafine is a system that is continuously enriched by new aesthetic and functional solutions. The modular structure, the same of the homonymous walk-in closet, offers maximum dimensional and compositional versatility: it is enriched by the sides in frame, also in glass, and by a large collection of doors – hinged, sliding, or coplanar, always distinguished by minimalistic lines and refined finishes. Chests of drawers, equipment, and accessories complete an advanced offer, able to adapt to any space.









Nelle pagine precedenti: armadio Senzafine Plus con ante battenti in laccato metallico bronzo e maniglie integrate Plus in brown nickel satinato. Day bed Bellport con rivestimento sfoderabile in tessuto Kitami 10 terracotta, cuscino a rullo con cinghia in cuoio 02 nero e piedini con profilo in brown nickel opaco. Tavolino Ilda con struttura in fusione d'ottone bronzata e piano in marmo noir saint laurent lucido. Pouf New York con rivestimento sfoderabile in tessuto Kitami 07 roccia. A sinistra: dettaglio dell'interno con ripiani in nobilitato ardesia e vassoi in nobilitato ardesia con piano in nobilitato canvas beige. Sotto: dettaglio delle maniglie integrate Plus in brown nickel satinato.

Previous pages: wardrobe Senzafine Plus with bronzo metallic lacquered leaf doors and integrated handles Plus in brushed brown nickel. Bellport day bed with removable cover in fabric Kitami 10 terracotta, roll cushion with belt in hide 02 nero and feet with profile in mat brown nickel. Ilda coffee table with structure in bronzed brass casting and top in glossy marble noir saint laurent. New York pouf with removable cover in fabric Kitami 07 roccia. To the left: close up of the inner shelves in melamine ardesia and trays in melamine ardesia with shelf in melamine canvas beige. Below: close up of the integrated handles Plus in brushed brown nickel.



Qui e nella pagina successiva: armadio Senzafine Plus con ante battenti in laccato metallico bronzo e maniglie integrate Plus in brown nickel satinato. Interni in nobilitato canvas beige con ripiani in nobilitato ardesia, vassoi in nobilitato ardesia con piano nobilitato in canvas beige e cassettera in nobilitato ardesia con frontali in nobilitato canvas beige, con luce led integrata. Pouf New York con rivestimento sfoderabile in tessuto Kitami 07 roccia. Day bed Bellport con rivestimento sfoderabile in tessuto Kitami 10 terracotta, cuscino a rullo con cinghia in cuoio 02 nero e piedini con profilo in brown nickel opaco. Tavolino llda con struttura in fusione d'ottone bronzata e piano in marmo noir saint laurent lucido.

This and next page: wardrobe Senzafine Plus with bronzo metallic lacquered leaf doors and integrated handles Plus in brushed brown nickel. Interior in melamine canvas beige with shelves in melamine ardesia, trays in melamine ardesia with shelf in melamine canvas beige and chest of drawers in melamine ardesia with fronts in melamine canvas beige, with integrated led light. New York pouf with removable cover in fabric Kitami 07 roccia. Bellport day bed with removable cover in fabric Kitami 10 terracotta, roll cushion with belt in hide 02 nero and feet with profile in mat brown nickel. llda coffee table with structure in bronzed brass casting and top in glossy marble noir saint laurent.







A sinistra: dettaglio dell'elemento portacamice con struttura e fianchetti in nobilitato ardesia e ripiani in tecnopelle 05 latte. Vano centrale attrezzato con cassettoni rivestiti in tessuto ardesia. Sotto: dettaglio dei frontali dei cassetti in nobilitato canvas beige con maniglia Step in tecnopelle 05 latte e ardesia opaco.

To the left: close up of the shirt storage unit with structure and sides in melamine ardesia, shelves in techno leather 05 latte. Central open compartment accessorized with small drawers covered in fabric ardesia. Below: close up of the drawer fronts in melamine canvas beige with handle Step in techno leather 05 latte and mat ardesia.



INTERIOR 01

Senzafine Plus

h 2590 p 609
 Apertura: battente.
 Ante: laccato metallico bronzo.
 Maniglie: integrate Plus, brown nickel satinato.
 Fianchi laterali: laccato metallico bronzo.
 Struttura: nobilitato canvas beige.
 Schienali: nobilitato canvas beige.
 Attrezzatura: nobilitato ardesia, nobilitato canvas beige, tecnopelle 05 latte.
 Parti metalliche: ardesia opaco.

Senzafine Plus

h 102" d 24"
 Opening: leaf doors.
 Doors: metallic lacquer bronzo.
 Handles: Plus integrated, brushed brown nickel.
 Lateral sides: metallic lacquer bronzo.
 Structure: canvas beige melamine.
 Backs: canvas beige melamine.
 Equipment: ardesia melamine, canvas beige melamine, techno leather 05 latte.
 Metal parts: mat ardesia.

Senzafine Plus
 Design R&D Poliform

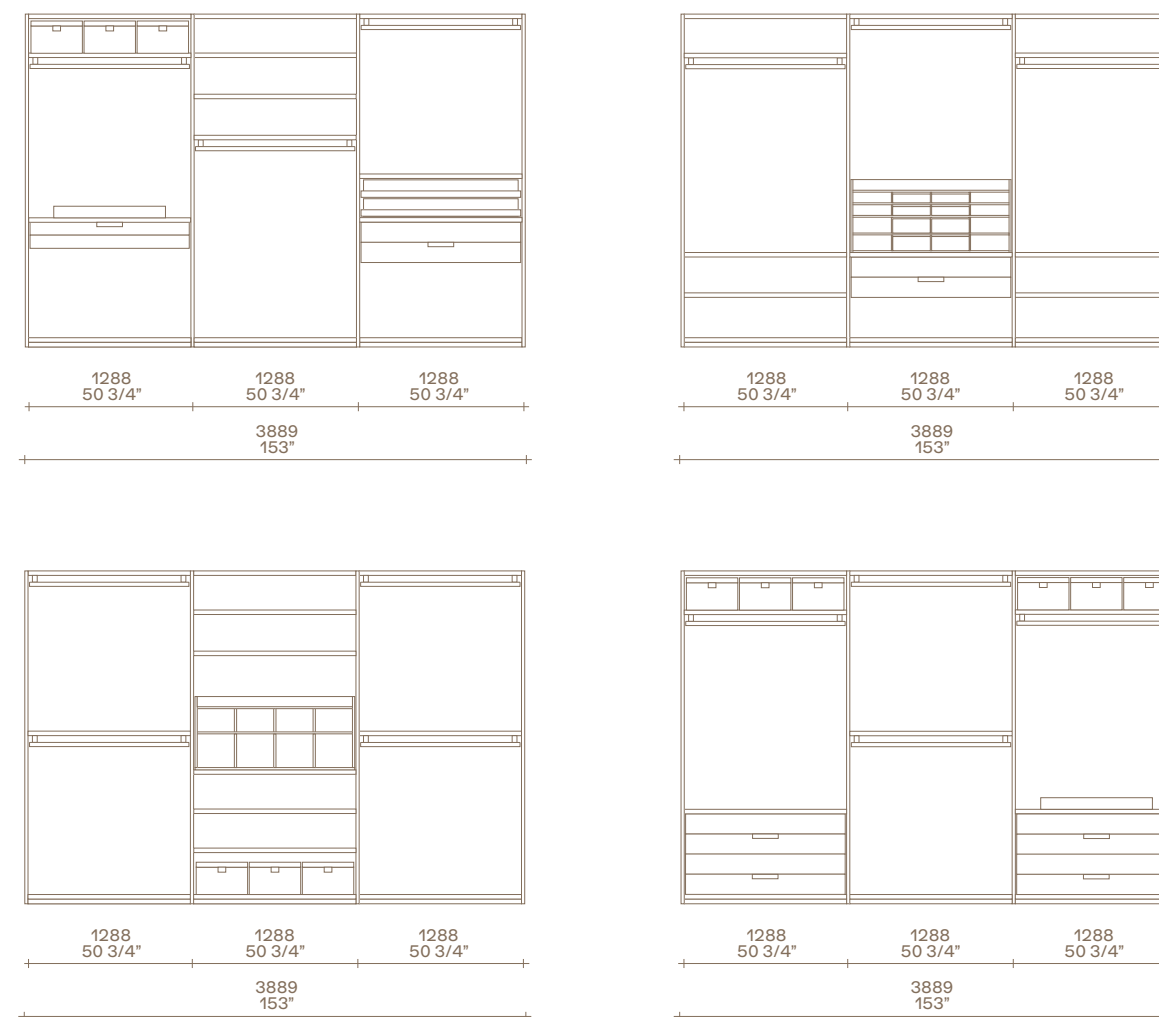





Nelle pagine precedenti: armadio Senzafine Plus con ante battenti in laccato opaco roccia e maniglie integrate Plus ardesia opaco. Al centro ante battenti Ego in vetro line con telaio e maniglie ardesia opaco. Poltrona BB rivestita in cuoio non sfoderabile 26 invecchiato. Pouf New York con rivestimento sfoderabile in tessuto Kitami 10 terracotta. Panca Home Hotel in olmo nero. A destra: dettaglio delle ante battenti Ego in vetro line con telaio e maniglie ardesia opaco. Interno in nobilitato canvas grigio e nobilitato ardesia, con luce led integrata. Cassettiera a vetrina con piano superiore in vetro fumé, cassetto con frontale a smusso laccato opaco ardesia e vassoi inferiori in nobilitato ardesia, piani in tecnopelle 01 elefante. Sotto: dettaglio delle maniglie integrate Plus ardesia opaco.

Previous pages: wardrobe Senzafine Plus with roccia mat lacquered doors and integrated handles Plus mat ardesia. Central leaf doors Ego in line glass with frame and mat ardesia handles. BB armchair covered in non-removable hide 26 invecchiato. New York with removable cover in fabric Kitami 10 terracotta. Home Hotel bench in black elm. To the right: close up of the leaf doors Ego in line glass with frame and handles mat ardesia. Interior in melamine canvas grigio and in melamine ardesia, with integrated led light. Showcase chest of drawers with top in fumé glass, drawer with bevelled front mat lacquered ardesia and lower trays in melamine ardesia, shelf in techno leather 01 elefante. Below: close up of the integrated handles Plus mat ardesia.





A sinistra: dettaglio delle ante battenti Ego in vetro line con telaio e maniglie ardesia opaco. Sotto: dettaglio del tubo appendiabiti ardesia opaco e ripiano in nobilitato ardesia con luce led integrata.

To the left: close up of the leaf doors Ego in glass line with frame and handles mat ardesia. Below: hanging bar mat ardesia and shelf in melamine ardesia with integrated led light.



In questa pagina: dettaglio della cassetiera a vetrina con piano superiore in vetro fumé. Cassetto con frontale a smusso laccato opaco ardesia e piano in tecnopelle 01 elefante. Sul retro del cassetto, un soffietto chiude lo spazio dell'estrazione.

This page: close up of the showcase chest of drawers with top in fumé glass. Drawer with bevelled front mat lacquered ardesia and shelf in techno leather 01 elefante. At the back of the drawer, a pleated fabric covers the extraction space.



INTERIOR 02

Senzafine Plus

h 2590 p 609
Apertura: battente.
Ante: laccato opaco roccia.
Maniglie: integrate Plus, ardesia opaco.
Fianchi laterali: laccato opaco roccia.
Struttura: nobilitato canvas grigio.
Schienali: nobilitato canvas grigio.
Attrezzatura: nobilitato ardesia, nobilitato canvas grigio.
Parti metalliche: ardesia opaco.

Senzafine Ego

Apertura: battente.
Ante: vetro line 2700 con telaio ardesia opaco.
Maniglie: Ego ardesia opaco.
Struttura: nobilitato canvas grigio.
Schienali: nobilitato canvas grigio.
Fianco telaio centrale: ardesia opaco.
Attrezzatura: nobilitato ardesia, nobilitato canvas grigio, tecnopelle 01 elefante, vetro fumé 3050.
Parti metalliche: ardesia opaco.

Senzafine Plus

h 102" d 24"
Opening: leaf doors.
Doors: mat lacquer roccia.
Handles: integrated Plus, mat ardesia.
Lateral sides: mat lacquer roccia.
Structure: canvas grigio melamine.
Backs: canvas grigio melamine.
Equipment: ardesia melamine, canvas grigio melamine.
Metal parts: mat ardesia.

Senzafine Ego

Opening: leaf doors.
Doors: glass line 2700 with frame mat ardesia.
Handles: Ego mat ardesia.
Structure: canvas grigio melamine.
Backs: canvas grigio melamine.
Central frame side: mat ardesia.
Equipment: ardesia melamine, canvas grigio melamine, techno leather 01 elefante, glass fumé 3050.
Metal parts: mat ardesia.

Senzafine Plus

Design R&D Poliform

Senzafine Ego

Design Giuseppe Bavuso

Cassettiera a vetrina - Showcase chest of drawers

Design Rodolfo Dordoni

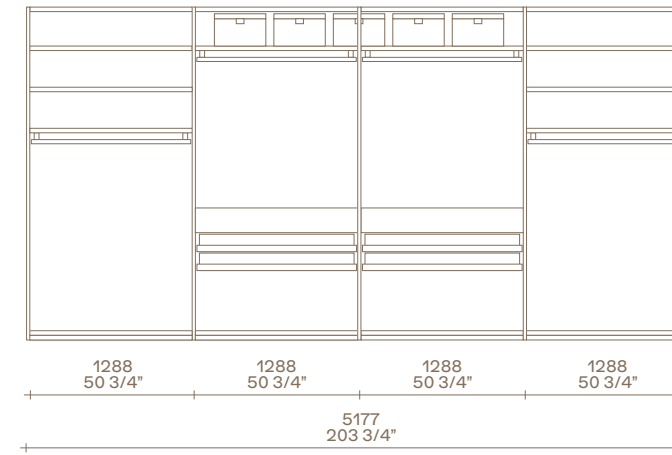







Qui e nelle pagine precedenti: armadio Senzafine Cover con ante battenti in tecnopelle 05 latte e profili champagne opaco, maniglie Cover in tecnopelle 05 latte e champagne opaco. Cabina armadio Senzafine in nobilitato olmo con fianchi a telaio in champagne opaco e schienali in metacrilato roller latte. Cassettiere a vetrina in laccato opaco champagne e cassetti inferiori in vetro riflettente fumé con maniglia Track champagne opaco. Poltrona Santa Monica con rivestimento sfoderabile in velluto Tebe 11 bruciato. Tavolino Nara in legno massello noce gold. A sinistra: dettaglio dell'interno in nobilitato olmo con schienali in nobilitato Skin laccato opaco 94 latte, elemento porta borse con ripiani in tecnopelle 05 latte, ripiano con frontale champagne opaco, luce led integrata. Sotto: dettaglio della maniglia Cover rivestita in tecnopelle 05 latte e champagne opaco.

Here and previous pages: wardrobe Senzafine Cover with leaf doors in techno leather 05 latte and mat champagne profiles, handles Cover in techno leather 05 latte and mat champagne. Senzafine walk-in closet in elm melamine with frame sides in mat champagne and backs in methacrylate roller latte. Display case chests of drawers in mat lacquered champagne and lower drawers in fumé reflecting glass with Track handle mat champagne. Santa Monica armchairs with removable cover in velvet Tebe 11 bruciato. Nara coffee table in gold walnut solid wood. To the left: close up of the interior in elm melamine with backs in 94 latte mat lacquered Skin melamine, handbag storage with shelves in techno leather 05 latte, shelf with front in mat champagne, integrated led light. Below: close up of the Cover handle in techno leather 05 latte and mat champagne.



In questa pagina: armadio Senzafine Cover con ante battenti in tessuto lino chiaro e profili champagne opaco, maniglie Fitted champagne opaco. Cabina armadio Senzafine in nobilitato olmo con fianchi a telaio in champagne opaco e schienali in metacrilato roller latte. Ripiani in nobilitato olmo con frontale champagne opaco e in tecnopelle 06 nocciola con telaio champagne opaco, luce led integrata. Cassettiere a vetrina in laccato opaco champagne e cassetti inferiori in nobilitato olmo con maniglia Track champagne opaco. Pouf New York con rivestimento sfoderabile in tessuto Antea 05 terra di siena.

This page: wardrobe Senzafine Cover with leaf doors in fabric lino chiaro and mat champagne profiles, Fitted handle in mat champagne. Senzafine walk-in closet in elm melamine with frame sides in mat champagne and backs in methacrylate roller latte. Shelves in elm melamine with mat champagne front and in techno leather 06 nocciola with mat champagne frame, integrated led light. Display case chests of drawers in mat lacquered champagne and lower drawers in elm melamine with Track handle mat champagne. New York pouf with removable cover in fabric Antea 05 terra di siena.





Sotto: dettaglio dell'anta Cover in tessuto lino chiaro con profili champagne opaco e maniglia Fitted in champagne opaco. A sinistra: dettaglio dell'interno in nobilitato olmo con luce led integrata. Camiciera con vassoi in nobilitato olmo, piani in tecnopelle 05 latte e spondine champagne opaco. Ripiani in tecnopelle 05 latte con telaio champagne opaco e in nobilitato olmo con frontale champagne opaco.

Below: close up of the Cover door in fabric lino chiaro with mat champagne profiles and Fitted handle in mat champagne. To the left: close up of the interior in elm melamine with integrated led light. Shirt storage with trays in elm melamine, shelves in techno leather 05 latte and mat champagne sides. Shelves in techno leather 05 latte with mat champagne frame and in elm melamine with mat champagne front.

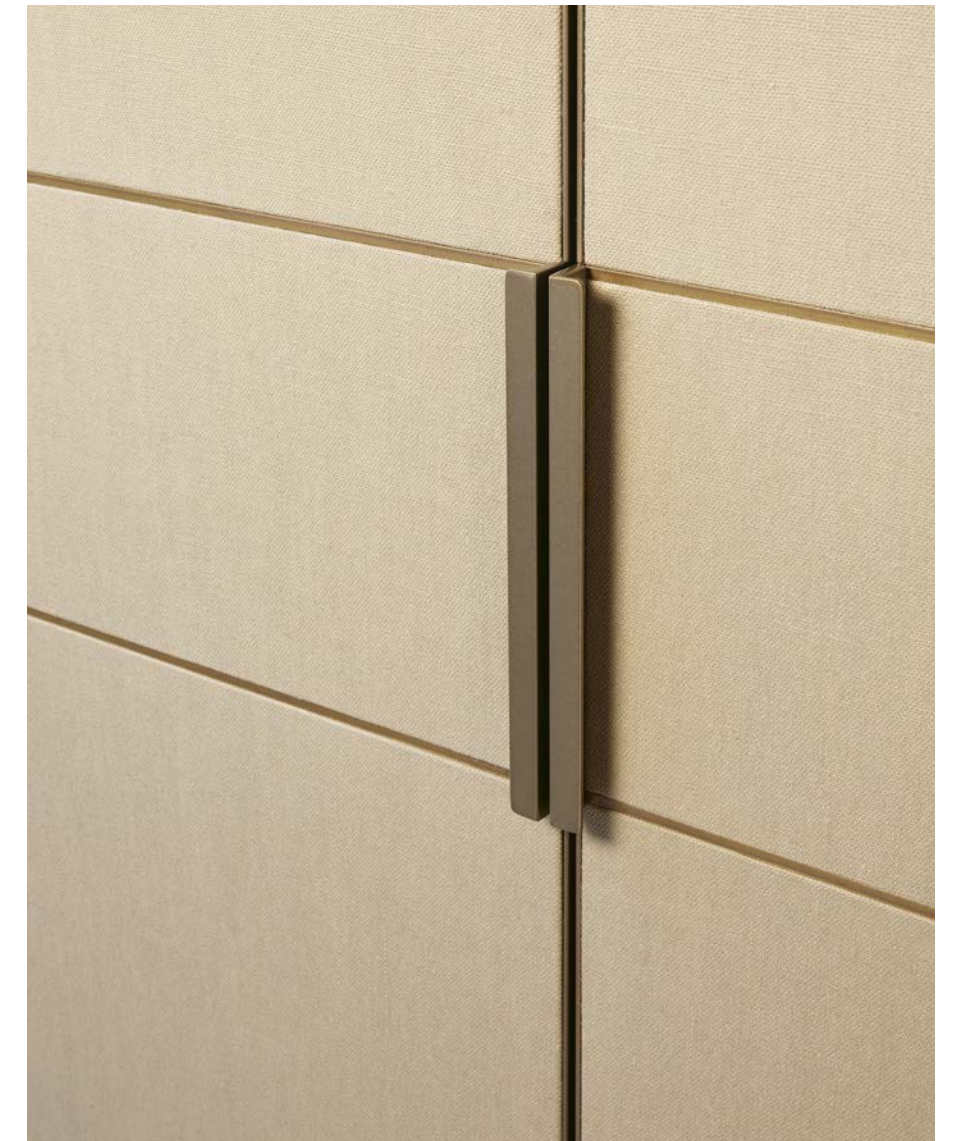



Qui e nella pagina successiva: armadio Senzafine Cover con sistema Code integrato. Ante Cover battenti in vetro acidato bronzo e profili ardesia opaco, maniglie Fitted in ardesia opaco, fianchi laterali in laccato metallico ottone. Boiserie Code in tessuto lino chiaro e profili ardesia opaco. Contenitore sospeso retroilluminato in laccato metallico ottone con top in marmo zecevo levigato e vano a giorno laccato opaco ottone. Mensolone retroilluminato in olmo nero, canalina attrezzata con passacavi in olmo nero con profili in ardesia opaco. Mensolone superiore in laccato metallico ottone con luce led integrata. Specchio Circle con cornice in cuoio 26 invecchiato e specchio bianco. Sedia Guest rivestita in velluto Tebe 08 notte non sfoderabile, con cuscino nella stessa finitura ma sfoderabile. Day bed Bellport con rivestimento sfoderabile in tessuto Arcadia 05 bronzo, cuscino a rullo con cinghia in cuoio 02 nero e piedini in brown nickel opaco. Tappeto Plain tortora.

Here and next page: wardrobe Senzafine Cover with integrated system Code. Cover leaf doors in etched glass bronze and mat ardesia profiles, Fitted handles in mat ardesia, lateral sides in metallic lacquered ottone. Wall panelling Code in fabric lino chiaro and mat ardesia profiles. Backlit suspended storage unit in metallic lacquered ottone with top in mat marble zecevo and ottone mat lacquered open compartment. Backlit thick shelf in black elm, channel for cable passage in black elm with profiles in mat ardesia. Upper thick shelf in metallic lacquered ottone with integrated led light. Circle mirror with frame in cuoio 26 invecchiato and white mirror. Guest chair covered in non-removable velvet Tebe 08 notte, with cushion in the same finish but removable. Bellport Day bed with removable cover in fabric Arcadia 05 bronzo, roll cushion with belt in hide 02 nero and mat brown nickel feet. Carpet Plain tortora.





Sotto: dettaglio dell'anta Cover in vetro acidato bronzo con profili ardesia opaco e maniglia Fitted in ardesia opaco. A sinistra: dettaglio dell'interno in nobilitato canvas beige con fianchi telaio in ardesia opaco. Cassettiera a vetrina con piano superiore in vetro fumé, cassetto con frontale a smusso in laccato opaco ardesia e piano in tecnopelle 01 elefante. Cassetti inferiori con frontali in vetro riflettente fumé con bordo e maniglia Track in ardesia opaco. Tubo appendiabiti rivestito in tecnopelle 01 elefante e ardesia opaco.

Below: close up of the Cover door in etched glass bronzo with mat ardesia profiles and Fitted handle in mat ardesia. To the left: close up of the interior in canvas beige melamine with frame sides in mat ardesia. Display case chest of drawers with top in fumé glass, drawer with front with chamfered edge in mat lacquered ardesia and shelf in techno leather 01 elefante. Lower drawers with fronts in fumé reflecting glass with edge and Track handle in mat ardesia. Hanging rail covered in techno leather 01 elefante and mat ardesia.



INTERIOR 03

Senzafine Cover tecnopelle

h 2590 p 609
Apertura: battente.
Ante: tecnopelle 05 latte con profili champagne opaco.
Maniglie: Cover champagne opaco e tecnopelle 05 latte.
Fianchi laterali: tecnopelle 05 latte.
Struttura: nobilitato olmo.
Schienali: nobilitato Skin laccato opaco 94 latte.
Attrezzatura: nobilitato olmo, tecnopelle 05 latte.
Parti metalliche: champagne opaco.

Senzafine Cover tessuto

h 2590 p 609
Apertura: battente.
Ante: tessuto lino chiaro con profili champagne opaco.
Maniglie: Fitted champagne opaco.
Fianchi laterali: tessuto lino chiaro.
Struttura: nobilitato olmo.
Schienali: nobilitato olmo.
Attrezzatura: nobilitato olmo, tecnopelle 05 latte.
Parti metalliche: champagne opaco.

Senzafine Cover vetro

h 2590 p 609
Apertura: battente.
Ante: vetro acidato 5323 bronzo con profili ardesia opaco.
Maniglie: Fitted ardesia opaco.
Fianchi laterali: laccato metallico ottone.
Struttura: nobilitato canvas beige.
Schienali: nobilitato canvas beige.
Fianchi telaio centrali: ardesia opaco.
Attrezzatura: nobilitato ardesia, vetro fumé 3050, vetro riflettente fumé 5059, tecnopelle 01 elefante.
Parti metalliche: ardesia opaco.

Code integrato

Pannelli boiserie: tessuto lino chiaro con profili ardesia opaco.
Mensoloni: superiore laccato metallico ottone, sospeso olmo nero.
Contenitore: cassetto laccato metallico ottone, vano a giorno laccato opaco ottone, top marmo zecevo levigato.

Senzafine Cover techno leather

h 102" d 24"
Opening: leaf doors.
Doors: techno leather 05 latte with mat champagne profiles.
Handles: Cover mat champagne and techno leather 05 latte.
Lateral sides: techno leather 05 latte.
Structure: elm melamine.
Backs: 94 latte mat lacquered Skin melamine.
Equipment: elm melamine, techno leather 05 latte.
Metal parts: mat champagne.

Senzafine Cover fabric

h 102" d 24"
Opening: leaf doors.
Doors: lino chiaro fabric with mat champagne profiles.
Handles: Fitted mat champagne.
Lateral sides: lino chiaro fabric.
Structure: elm melamine.
Backs: elm melamine.
Equipment: elm melamine, techno leather 05 latte.
Metal parts: mat champagne.

Senzafine Cover glass

h 102" d 24"
Opening: leaf doors.
Doors: etched glass 5323 bronzo with mat ardesia profiles.
Handles: Fitted mat ardesia.
Lateral sides: metallic lacquer ottone.
Structure: canvas beige melamine.
Backs: canvas beige melamine.
Central frame sides: mat ardesia.
Equipment: ardesia melamine, fumé glass 3050, fumé reflecting glass 5059, techno leather 01 elefante.
Metal parts: mat ardesia.

Code integrated system

Wall panelling: lino chiaro fabric with mat ardesia profiles.
Thick shelves: on the top metallic lacquer ottone, desk in black elm.
Storage unit: drawer metallic lacquer ottone, open storage unit mat lacquer ottone, top zecevo mat marble.

Senzafine Cover tecnopelle

Design R&D Poliform

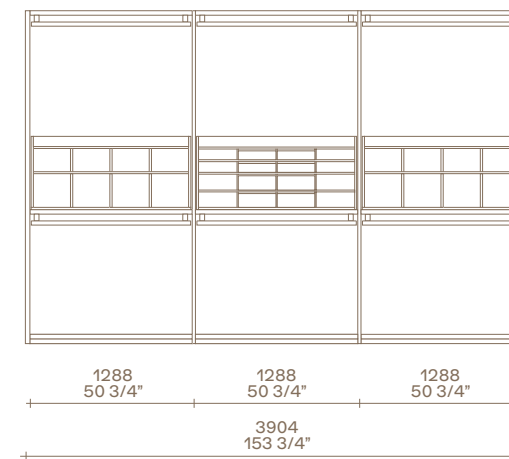

Senzafine Cover tessuto

Design R&D Poliform

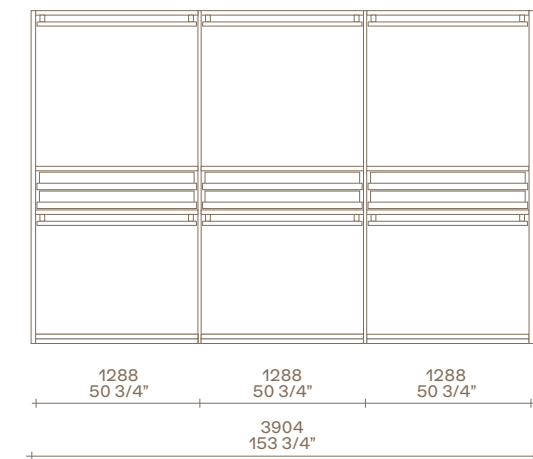

Senzafine Cover vetro

Design R&D Poliform

Code

Design R&D Poliform

Cassettiera a vetrina - Showcase chest of drawers

Design Rodolfo Dordoni

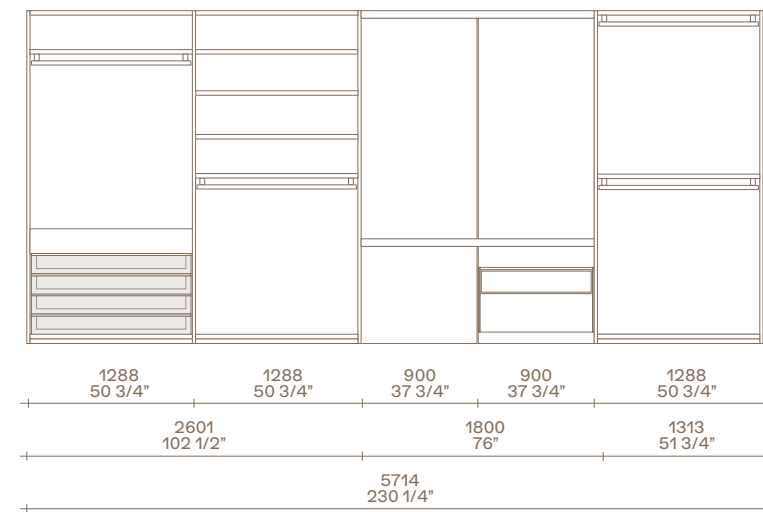







Nella pagina precedente: armadio Senzafine Fitted con ante battenti in vetro trasparente riflettente, telaio e maniglie laccato opaco carbone. Interno in nobilitato rovere cenere con fianchi telaio centrali ardesia opaco e luce led integrata. Cassettiera in nobilitato rovere cenere con maniglie Track ardesia opaco, piano superiore in tecnopelle 01 elefante e telaio ardesia opaco. Poltrona Mad Chair in pelle non sfoderabile Cashmere grigio con basamento girevole brown nickel lucido. Tavolino Dama in laccato lucido visone. Pouf New York in tessuto sfoderabile Zante 10 nero e piedini brown nickel lucido. Tappeto Frame carbone. A sinistra: dettaglio dei ripiani in vetro fumé con telaio ardesia opaco e luce led integrata. Sotto: dettaglio dell'anta in vetro trasparente riflettente con telaio e maniglie in opaco carbone.

Previous page: wardrobe Senzafine Fitted with leaf doors in transparent reflecting glass, mat lacquered carbone frame and handles. Interior in cenere oak melamine and mat ardesia central frame sides, integrated led light. Chest of drawers in cenere oak melamine with mat ardesia Track handles, top in techno leather 01 elefante and mat ardesia frame. Armchair Mad Chair covered in non-removable leather Cashmere grigio with glossy brown nickel swivel base. Coffee table Dama in glossy lacquered visone. Pouf New York in removable fabric Zante 10 nero and glossy brown nickel feet. Carpet Frame carbone. To the left: close up of the shelves in fumé glass with mat ardesia frame and integrated led light. Below: close up of the door in transparent reflecting glass with mat carbone handles.





Qui e nella pagina precedente: armadio Senzafine Fitted con ante battenti in vetro trasparente riflettente, telaio e maniglie laccato opaco carbone. Interno in nobilitato rovere cenere con fianchi telaio centrali ardesia opaco. Ripiani in vetro fumé con telaio ardesia opaco e luce led integrata. Tubi appendiabiti ardesia opaco. Poltrone Mad Chair in pelle non sfoderabile Cashmere grigio con basamento girevole brown nickel lucido. Tavolino Soori in metallo finitura bronzo anticato. Pouf New York in tessuto sfoderabile Zante 10 nero e piedini brown nickel lucido. Tappeto Frame carbone.

This and previous page: wardrobe Senzafine Fitted with leaf doors in transparent reflecting glass, mat lacquered carbone frame and handles. Interior in nobilitato rovere cenere con fianchi telaio centrali ardesia opaco. Shelves in fumé glass with mat ardesia frame and integrated led light. Hanging bars mat ardesia. Mad Chair armchairs covered in non-removable leather Cashmere grigio with glossy brown nickel swivel base. Soori coffee table in metal with antique bronze finish. New York pouf in removable fabric Zante 10 nero and glossy brown nickel feet. Carpet Frame carbone.

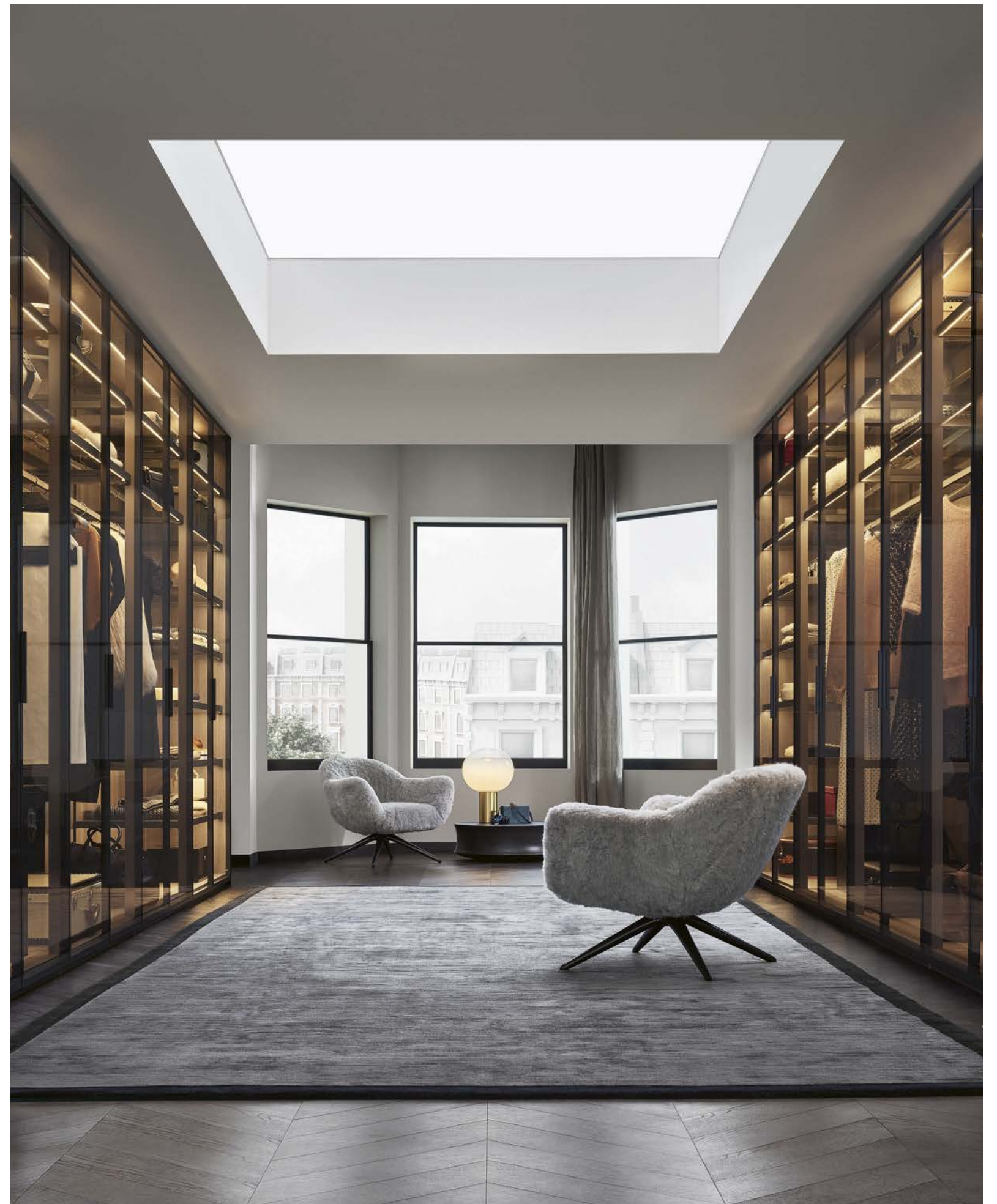







Qui e nelle pagine precedenti: armadi Senzafine Bangkok con ante battenti in cuoio 26 invecchiato con profili maniglie in brown nickel lucido e sistema Quid integrato. Armadio Senzafine Ego con ante battenti in vetro trasparente riflettente e telaio ardesia opaco, fianchi laterali e schienali in vetro trasparente riflettente. Poltrone Jane in tessuto sfoderabile Paros 06 arena e basamento in brown nickel lucido. A sinistra: Quid Vanity integrato, pannelli boiserie in olmo nero e specchio con mensoline laccato opaco carbone, mensola in olmo nero con bacheche laccato opaco ardesia, ante ribalta laccato opaco carbone, ripiani in vetro trasparente, illuminazione led dimmerabile. Pouf Onda in pelle non sfoderabile Soft 02 mastice. Tappeto Plain tortora. Sotto: dettaglio dei profili maniglia in brown nickel lucido.

This and previous pages: wardrobes Senzafine Bangkok with leaf doors in hide 26 invecchiato with handle profiles in glossy brown nickel, integrated Quid system. Wardrobe Senzafine Ego with leaf doors in transparent reflecting glass and mat ardesia frame, lateral sides and backs in transparent reflecting glass. Jane armchairs in removable fabric Paros 06 arena and glossy brown nickel base. To the left: integrated Quid vanity with wall panelling in black elm and mirror with carbone mat lacquered shelves, black elm shelf with ardesia mat lacquered open display cases, flap doors in carbone mat lacquer, shelves in transparent glass, led lighting with dimmer. Onda pouf in non-removable leather Soft 02 mastice. Carpet Plain tortora. Below: close up of the of the handle profiles in glossy brown nickel.



In questa pagina: Quid integrato con pannelli boiserie in olmo nero, bacheche laccato opaco ardesia con ripiani in vetro trasparente e cassette in olmo nero con maniglie in brown nickel opaco, illuminazione led dimmerabile. Armadio Senzafine Bangkok con ante battenti in cuoio 26 invecchiato con profili maniglie in brown nickel lucido.

This page: integrated Quid composition, black elm wall panelling, ardesia mat lacquered open display cases with transparent glass shelves and black elm drawers with mat brown nickel handles, led lighting with dimmer. Wardrobe Senzafine Bangkok with leaf doors in hide 26 invecchiato with handle profiles in glossy brown nickel.



INTERIOR 05

Senzafine Bangkok

h 2590 p 614
Apertura: battente.
Ante: cuoio 26 invecchiato.
Profili maniglia: brown nickel lucido.
Fianchi laterali: laccato opaco ardesia.
Struttura: nobilitato rovere spessart.
Schienali: nobilitato rovere spessart.
Attrezzatura: nobilitato rovere spessart, tecnopelle 02 moro.
Parti metalliche: ardesia opaco.

Quid integrato
Pannelli boiserie: olmo nero.
Bacheche: laccato opaco ardesia.
Cassetti: olmo nero, maniglie brown nickel opaco.
Ripiani: vetro trasparente 1000.

B - Quid Vanity integrato
Pannelli boiserie: olmo nero, specchio bianco 4000.
Mensole: laccato opaco carbone.
Mensolone: olmo nero.
Bacheche: laccato opaco ardesia.
Ante ribalta: laccato opaco carbone.
Ripiani: vetro trasparente 1000.

Senzafine Ego

h 2270 p 626
Apertura: battente.
Ante: vetro trasparente riflettente 5000 con telaio ardesia opaco.
Maniglie: Ego ardesia opaco.
Fianchi vetro laterali: vetro trasparente riflettente 5000 con telaio ardesia opaco.
Struttura: nobilitato rovere spessart.
Schienali: vetro trasparente riflettente 5000.
Fianco telaio centrale: ardesia opaco.
Attrezzatura: nobilitato rovere spessart, vetro fumé 3050.
Parti metalliche: ardesia opaco.

Senzafine Bangkok

h 102" d 24 1/4"
Opening: leaf doors.
Doors: hide 26 invecchiato.
Handle profiles: glossy brown nickel.
Lateral sides: mat lacquer ardesia.
Structure: spessart oak melamine.
Backs: spessart oak melamine.
Equipment: spessart oak melamine, techno leather 02 moro.
Metal parts: mat ardesia.

Quid integrated system
Wall panelling: black elm.
Open display cases: mat lacquer ardesia.
Drawers: black elm, glossy brown nickel handles.
Shelves: transparent glass 1000.

B - Quid integrated Vanity
Wall panelling: black elm, white mirror 4000.
Shelves: mat lacquer carbone.
Thick shelf: black elm.
Open display cases: mat lacquer ardesia.
Flap doors: mat lacquer carbone.
Shelves: transparent glass 1000.

Senzafine Ego

h 89 1/4" d 24 3/4"
Opening: leaf doors.
Doors: transparent reflecting glass 5000 with mat ardesia frame.
Handles: Ego mat ardesia.
Lateral glass sides: transparent reflecting glass 5000 with mat ardesia frame.
Structure: spessart oak melamine.
Backs: transparent reflecting glass 5000.
Central frame side: mat ardesia.
Equipment: spessart oak melamine, fumé glass 3050.
Metal parts: mat ardesia.

Senzafine Bangkok

Design Operadesign

Quid

Design R&D Poliform

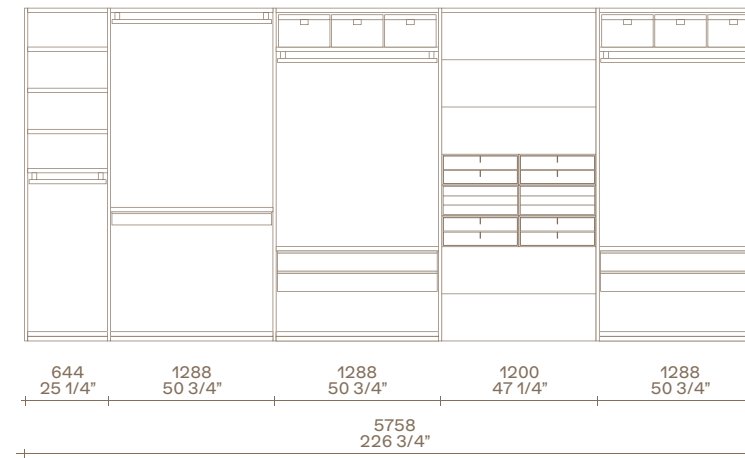
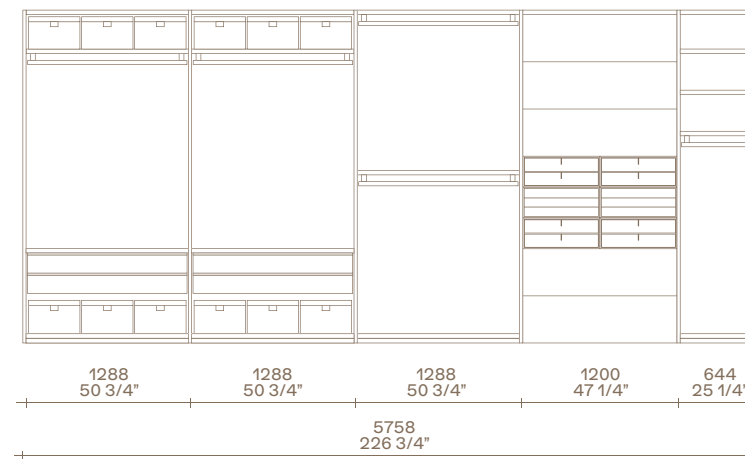

B

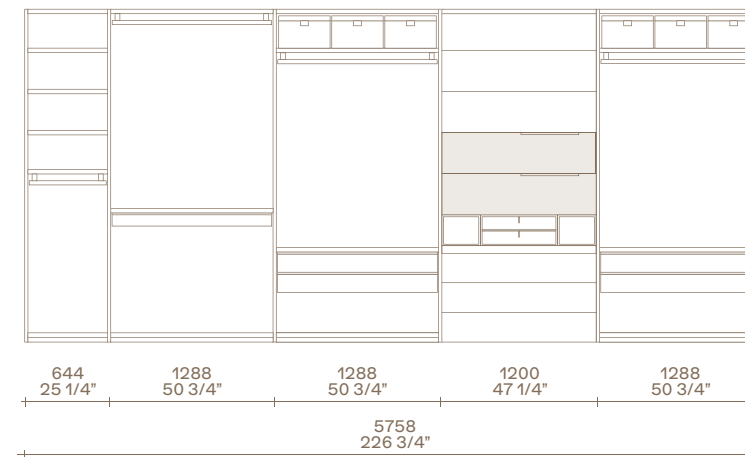

Senzafine Ego

Design Giuseppe Bavuso

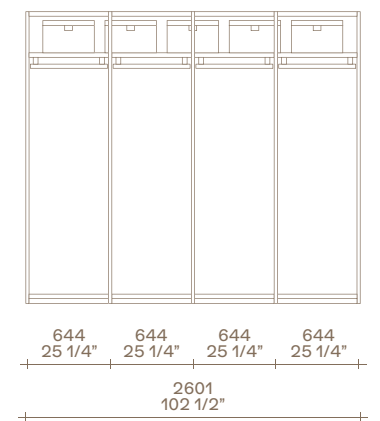







Qui e nelle pagine precedenti: armadio Senzafine Ocean con ante battenti in vetro acidato bronzo, telaio e maniglie Sydney a incasso ardesia opaco. Tavolo Kensington con struttura in spatolato bronzo e piano in olmo nero. Pouf Onda con rivestimento non sfoderabile in pelle Nabuk 09 ruggine. Tappeto Plain cipria. A sinistra: dettaglio dell'interno in nobilitato ardesia con schienali in metacrilato roller ardesia. Cassettiera con frontali cassetti in metacrilato roller ardesia e maniglia Track ardesia opaco, piano superiore in tecnopelle 01 elefante e telaio ardesia opaco. Sotto: dettaglio delle maniglie Sydney a incasso ardesia opaco.

This and previous pages: wardrobe Senzafine Ocean with leaf doors in etched glass bronzo, profile and built-in Sydney handles mat ardesia. Kensington table with structure in metal bronzo with spatula effect and top in black elm. Onda pouf with non-removable cover in leather Nabuk 09 ruggine. Carpet Plain cipria. To the left: close up of the interior in melamine ardesia with backs in methacrylate roller ardesia. Chest of drawers with drawer fronts in methacrylate roller ardesia and mat ardesia Track handle, upper shelf in techno leather 01 elefante and mat ardesia frame. Below: close up of the built-in handles Sydney in mat ardesia.



INTERIOR 06

Senzafine Ocean

h 2910 p 609

Apertura: battente.

Ante: vetro acidato bronzo 5323 con telaio ardesia opaco, interno laccato opaco ardesia.

Maniglie: Sydney a incasso, ardesia opaco.

Fianchi laterali: laccato opaco ardesia.

Struttura: nobilitato ardesia.

Schienali: metacrilato roller ardesia.

Attrezzatura: nobilitato ardesia, metacrilato roller ardesia, tecnopelle 01 elefante.

Parti metalliche: ardesia opaco.

Senzafine Ocean

h 114 1/2" d 24"

Opening: leaf doors.

Doors: etched glass bronzo 5323 with mat ardesia profile, mat lacquered ardesia inner side.

Handles: Sydney built-in, mat ardesia.

Lateral sides: mat lacquer ardesia.

Structure: ardesia melamine.

Backs: methacrylate roller ardesia.

Equipment: ardesia melamine, methacrylate roller ardesia, techno leather 01 elefante.

Metal parts: mat ardesia.

Senzafine Ocean

Design R&D Poliform

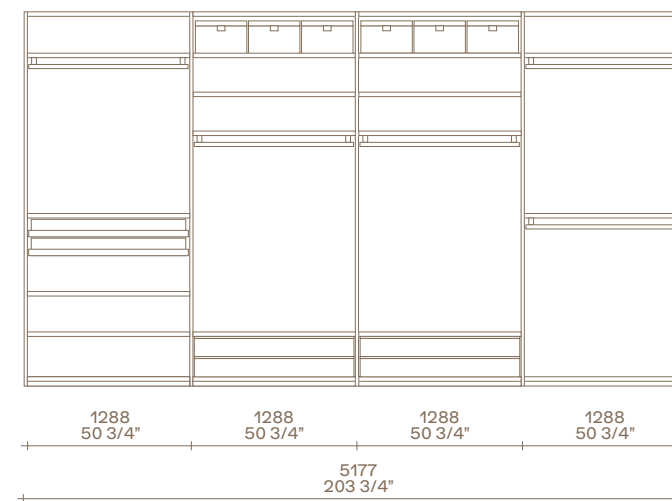







Qui e nelle pagine precedenti: armadio Senzafine apertura battente in una composizione a doppia profondità, Senzafine New Entry p 464 con ante laccato opaco bianco. Parte centrale Senzafine Fitted p 609 con ante in vetro trasparente riflettente e telaio ardesia opaco. Interno in nobilitato rovere cenere con fianchi telaio centrali ardesia opaco e luce led integrata. Ripiani in vetro fumé e in tecnopelle 02 moro con telaio ardesia opaco. Cassettiera a isola Senzafine in rovere cenere. Poltrone Mad Chair in velluto sfoderabile Persia 54 prussia e gambe in rovere spessart. Sotto: dettaglio del vassoio in nobilitato rovere cenere con piano in tecnopelle 02 moro. Svuotatasche laccato opaco ardesia con piano superiore e fondo rivestiti in tecnopelle 02 moro.

This and previous page: wardrobe Senzafine with leaf opening in a double depth composition, Senzafine New Entry d 18 1/4" with bianco mat lacquered doors. Central part, Senzafine Fitted d 24" with reflecting transparent glass doors and mat ardesia frame. Interior in cenere oak melamine and mat ardesia central frame sides, integrated led light. Fumé glass and 02 moro techno leather shelves with mat ardesia frame. Senzafine island chest of drawers in cenere oak. Mad Chair armchairs in removable velvet Persia 54 prussia, legs in spessart oak. Below: close up of the tray in cenere oak melamine with shelf in techno leather 02 moro. Jewellery tray mat lacquer ardesia with top and bottom covered in techno leather 02 moro.





Nella pagina precedente: dettaglio dell'interno in nobilitato rovere cenere, ripiani in vetro fumé e in tecnopelle 02 moro con telaio ardesia opaco, cassetteria in nobilitato rovere cenere con maniglie Track ardesia opaco. A destra: dettaglio della cassetteria in nobilitato rovere cenere con maniglie Track ardesia opaco, vassoi in nobilitato rovere cenere con piano in tecnopelle 02 moro. Contenitore svuotatasche laccato opaco ardesia. Ripiani in vetro fumé e nobilitato rovere cenere con telaio ardesia opaco e luce led integrata. Tubo appendiabiti ardesia opaco.

Previous page: close up of the interior in cenere oak melamine, shelves in fumé glass and in techno leather 02 moro with mat ardesia frame, chest of drawers in cenere oak melamine with mat ardesia Track handles. To the right: close up of the chest of drawers in cenere oak melamine with mat ardesia Track handles, trays in cenere oak melamine with shelves in techno leather 02 moro. Ardesia mat lacquered jewellery tray. Shelves in fumé glass and cenere oak melamine with mat ardesia frame and integrated led light. Mat ardesia hanging bar.



INTERIOR 07

Senzafine New Entry

h 2590 p 464
 Apertura: battente.
 Ante: laccato opaco bianco.
 Maniglie: Fitted laccato opaco bianco.
 Fianchi laterali: laccato opaco bianco.
 Struttura: nobilitato rovere cenere.
 Schienali: nobilitato rovere cenere.
 Attrezzatura: nobilitato rovere cenere, vetro fumé 3050, tecnopelle 02 moro, laccato opaco ardesia.
 Parti metalliche: ardesia opaco.

Senzafine New Entry

h 102" d 18 1/4"
 Opening: leaf doors.
 Doors: bianco mat lacquer.
 Handles: Fitted bianco mat lacquer.
 Lateral sides: bianco mat lacquer.
 Structure: cenere oak melamine.
 Backs: cenere oak melamine.
 Equipment: cenere oak melamine, fumé glass 3050, techno leather 02 moro, ardesia mat lacquer.
 Metal parts: mat ardesia.

Senzafine Fitted

h 2590 p 612
 Apertura: battente.
 Ante: vetro trasparente riflettente 5000 con telaio ardesia opaco.
 Maniglie: Fitted ardesia opaco.
 Struttura: nobilitato rovere cenere.
 Schienali: nobilitato rovere cenere.
 Fianco telaio centrale: ardesia opaco.
 Attrezzatura: nobilitato rovere cenere, vetro fumé 3050, tecnopelle 02 moro.
 Parti metalliche: ardesia opaco.

Senzafine Fitted

h 102" d 24"
 Opening: leaf doors.
 Doors: transparent reflecting glass 5000 with mat ardesia frame.
 Handles: Fitted mat ardesia.
 Structure: cenere oak melamine.
 Backs: cenere oak melamine.
 Central frame side: mat ardesia.
 Equipment: cenere oak melamine, fumé glass 3050, techno leather 02 moro.
 Metal parts: mat ardesia.

Senzafine New Entry

Design R&D Poliform

Senzafine Fitted

Design Rodolfo Dordoni

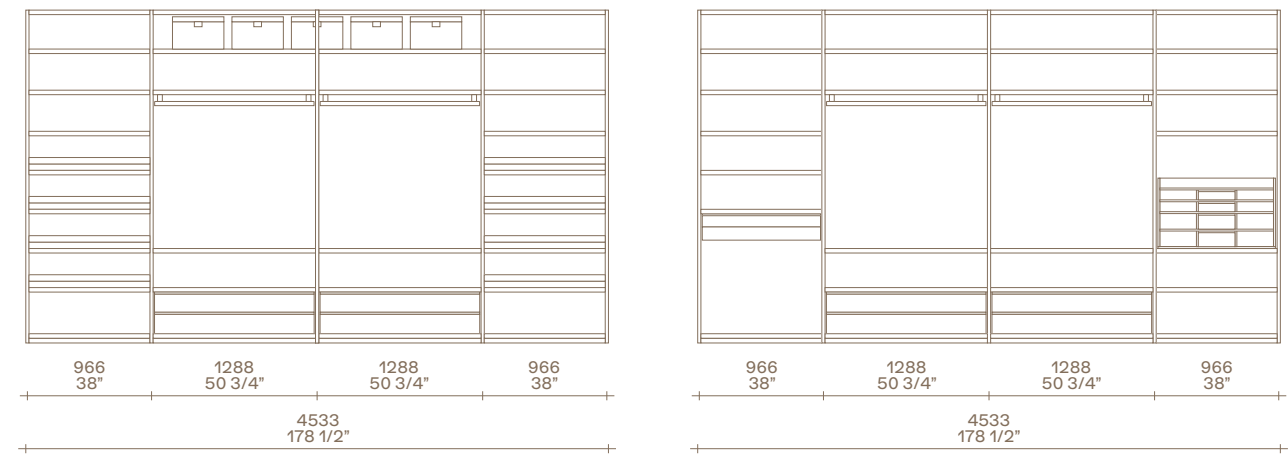

Senzafine New Entry

Design R&D Poliform

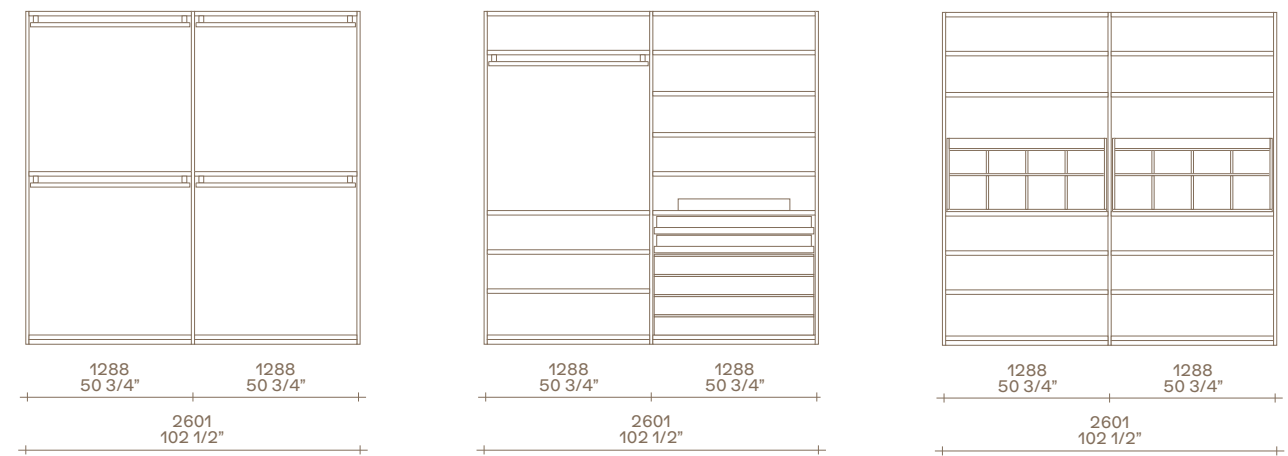





Qui e nelle pagine precedenti: armadi Senzafine Fitted con ante battenti in vetro trasparente riflettente e telaio ardesia opaco, vetrine centrostanza con fianchi laterali e schienali in vetro trasparente riflettente, con luce led integrata. Armadio Senzafine New Entry con ante battenti in laccato opaco visone e maniglie Fitted ardesia opaco. Pouf Onda in velluto sfoderabile Persia 1403 ocra.

This and previous pages: wardrobes Senzafine Fitted with leaf doors in transparent reflecting glass and mat ardesia frame, glass units as room dividers with lateral sides and backs in transparent reflecting glass, shelves with integrated led light. Wardrobe Senzafine New Entry with visone mat lacquered doors and mat ardesia Fitted handles. Onda pouf in removable velvet Persia 1403 ocra.

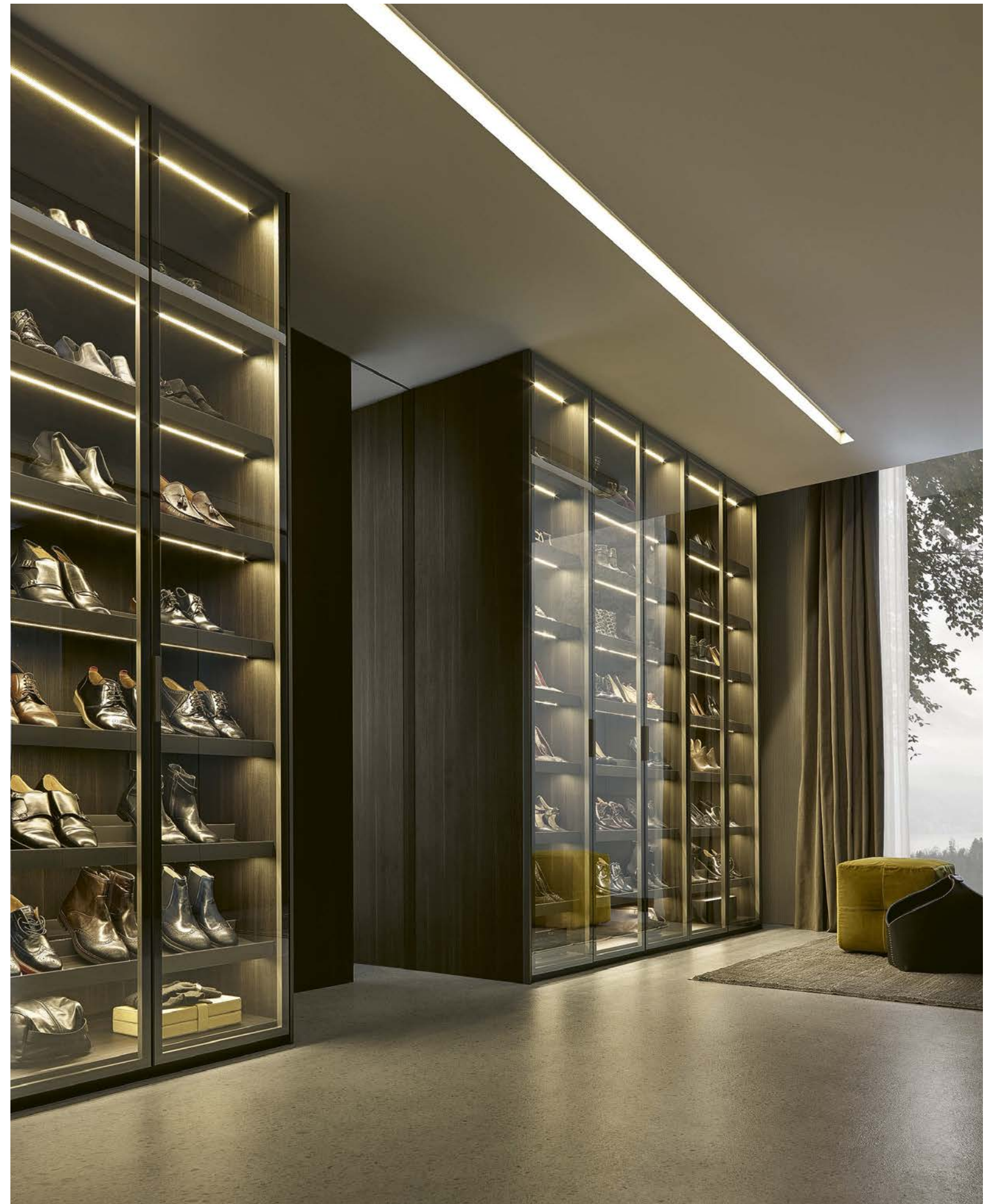



In questa pagina: armadio Senzafine Fitted con ante in vetro trasparente riflettente e telaio ardesia opaco. A sinistra: dettaglio del ripiano portascarpe in nobilitato rovere spessart con bordi ardesia opaco. Sotto: dettaglio del ripiano in tecnopelle 06 nocciola con telaio ardesia opaco.

This page: wardrobe Senzafine Fitted with glass doors in transparent reflecting glass and mat ardesia frame. To the left: close up of the shoe shelves in spessart oak melamine with mat ardesia edges. Below: close up of the shelf in techno leather 06 nocciola with mat ardesia frame.





Nella pagina precedente: armadio Senzafine New Entry con ante battenti in laccato opaco visone e maniglie integrate Fitted ardesia opaco. Letto Laze testata e base imbottite con rivestimento sfoderabile in pelle Nabuk 02 tortora. Comodino Onda in rovere spessart con piano in marmo calacatta oro lucido. A destra: dettaglio del ripiano in vetro fumé con telaio ardesia opaco, tubo appendiabiti rivestito in tecnopelle 06 nocciola e ardesia opaco, interno armadio in nobilitato rovere spessart, con luce led integrata.

Previous page: wardrobe Senzafine New Entry with visone mat lacquered leaf doors and integrated handles Fitted mat ardesia. Laze bed with padded headboard and base with removable cover in leather Nabuk 02 tortora. Onda night table in spessart oak with top in glossy marble calacatta oro. To the right: close up of the shelf in fumé glass with mat ardesia frame, hanging bar covered in techno leather 06 nocciola and mat ardesia, wardrobe interior in spessart oak melamine, integrated led light.

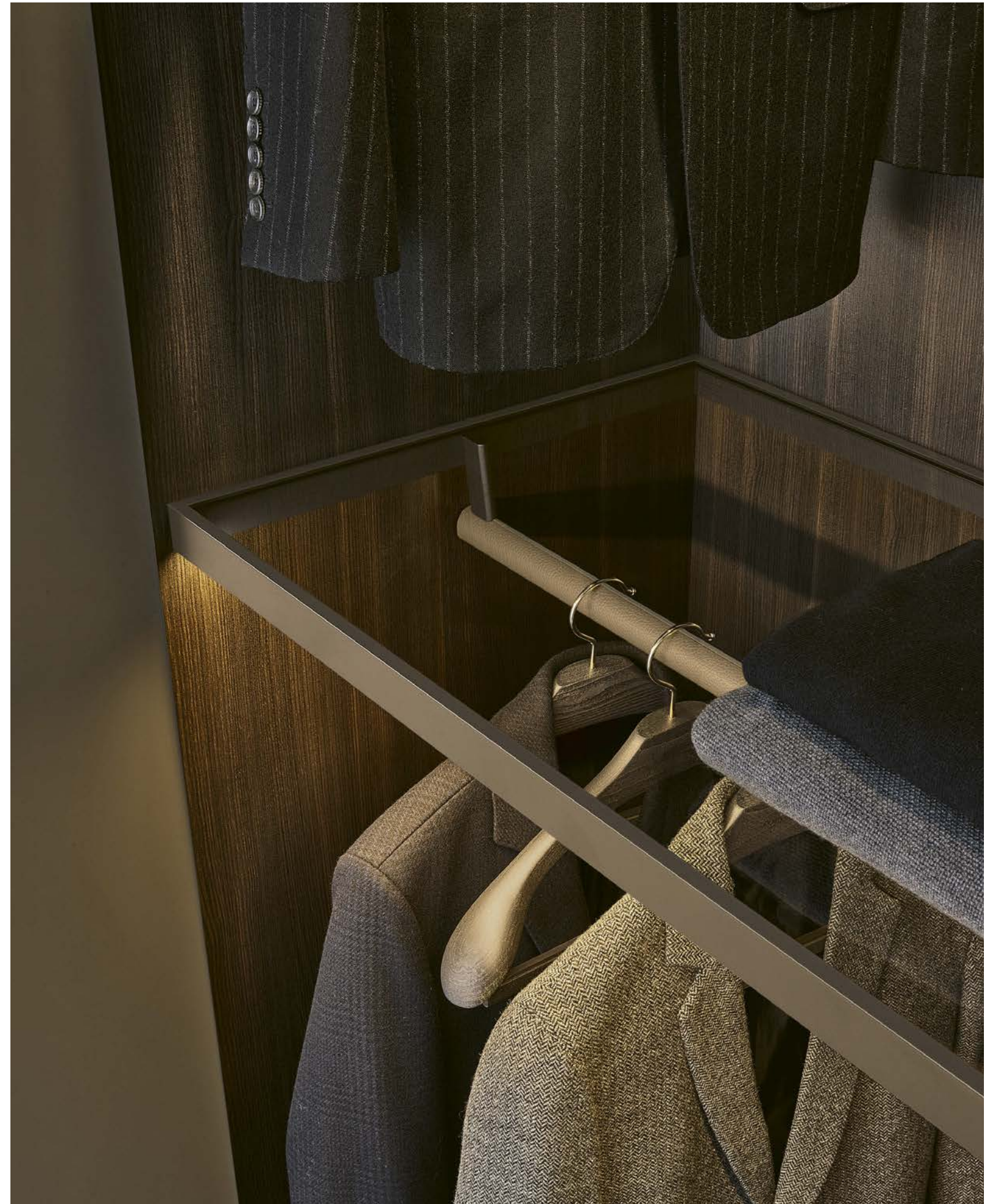

Senzafine Fitted A

h 2590 p 612
 Apertura: battente.
 Ante: vetro trasparente riflettente 5000 con telaio ardesia opaco.
 Maniglie: Fitted ardesia opaco.
 Fianchi laterali: laccato opaco ardesia.
 Struttura: nobilitato rovere spessart.
 Schienali: nobilitato rovere spessart.
 Attrezzatura: nobilitato rovere spessart.
 Parti metalliche: ardesia opaco.

Senzafine Fitted B

h 2270 p 612
 Apertura: battente.
 Ante: vetro trasparente riflettente 5000 con telaio ardesia opaco.
 Maniglie: Fitted ardesia opaco.
 Fianchi laterali: vetro trasparente riflettente 5000 con telaio ardesia opaco.
 Struttura: nobilitato ardesia.
 Schienali: vetro trasparente riflettente 5000.
 Attrezzatura: tecnopelle 06 nocciola, nobilitato ardesia.
 Parti metalliche: ardesia opaco.

Senzafine New Entry

h 2590 p 609
 Apertura: battente.
 Ante: laccato opaco visone.
 Maniglie: Fitted ardesia opaco.
 Fianchi laterali: laccato opaco visone.
 Struttura: nobilitato rovere spessart.
 Schienali: nobilitato rovere spessart.
 Attrezzatura: nobilitato rovere spessart, vetro fumé 3050, vetro riflettente fumé 5059, tecnopelle 06 nocciola.
 Parti metalliche: ardesia opaco.

Senzafine Fitted A

h 102" d 24"
 Opening: leaf doors.
 Doors: transparent reflecting glass 5000 with mat ardesia frame.
 Handles: Fitted mat ardesia.
 Lateral sides: ardesia mat lacquer.
 Structure: spessart oak melamine.
 Backs: spessart oak melamine.
 Equipment: spessart oak melamine.
 Metal parts: mat ardesia.

Senzafine Fitted B

h 89 1/4" d 24"
 Opening: leaf doors.
 Doors: transparent reflecting glass 5000 with mat ardesia frame.
 Handles: Fitted mat ardesia.
 Lateral sides: transparent reflecting glass 5000 with mat ardesia frame.
 Structure: ardesia melamine.
 Backs: transparent reflecting glass 5000.
 Equipment: techno leather 06 nocciola, ardesia melamine.
 Metal parts: mat ardesia.

Senzafine New Entry

h 102" d 24"
 Opening: leaf doors.
 Doors: visone mat lacquer.
 Handles: Fitted ardesia mat lacquer.
 Lateral sides: visone mat lacquer.
 Structure: spessart oak melamine.
 Backs: spessart oak melamine.
 Equipment: spessart oak melamine, fumé glass 3050, fumé reflecting glass 5059, techno leather 06 nocciola.
 Metal parts: mat ardesia.

Senzafine Fitted
 Design Rodolfo Dordoni

A

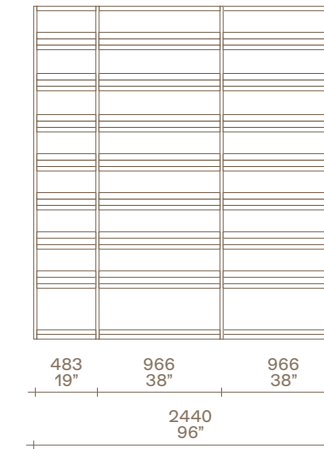
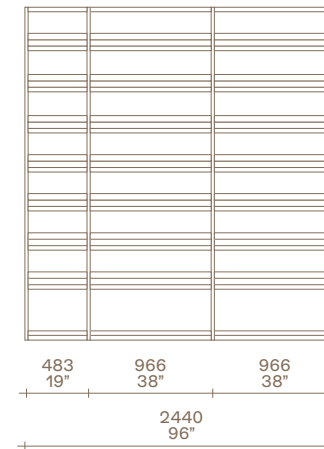

B

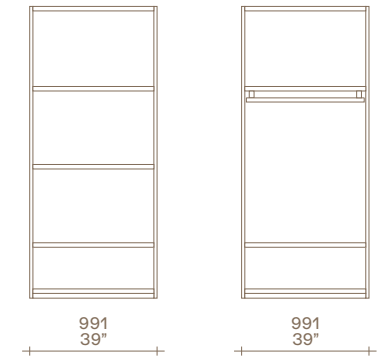

Senzafine New Entry
 Design R&D Poliform

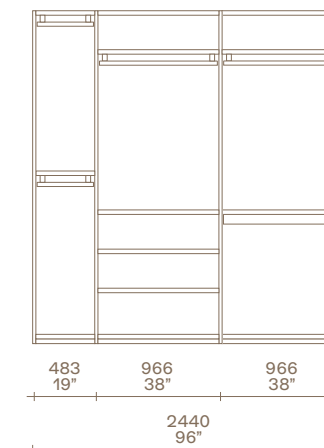
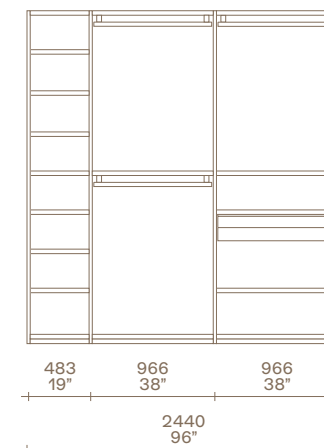
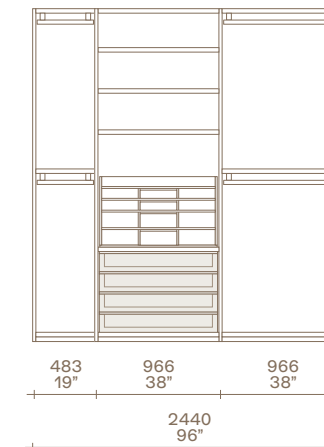





Qui e nelle pagine precedenti: armadio Senzafine Ocean con ante battenti in vetro satinato nero e telaio laccato opaco carbone, maniglie Sydney a incasso laccato opaco carbone. Armadi Senzafine Fitted con ante battenti in vetro fumé e telaio laccato opaco carbone. Quid integrato con pannelli boiserie in olmo nero, bacheche laccato opaco carbone con ripiani in vetro trasparente e cassetti in cuoio 26 invecchiato con maniglie in brown nickel opaco, illuminazione led dimmerabile. Pouf Onda con rivestimento in velluto sfoderabile Persia 2006 prugna. Tappeto Dama. Sotto: dettaglio della maniglia Sydney a incasso laccato opaco carbone. Interno in nobilitato rovere spessart, cassetti in vetro riflettente fumé con bordo e maniglia Track in ardesia opaco, piano superiore in tecnopelle 05 latte e telaio ardesia opaco.

This and previous pages: wardrobe Senzafine Ocean with leaf doors in mat glass nero and carbone mat lacquered frame, built-in Sydney handles in carbone mat lacquer. Wardrobes Senzafine Fitted with leaf doors in fumé glass and carbone mat lacquered frame. Integrated Quid unit with wall panels in black elm, carbone mat lacquered open display cases with shelves in transparent glass and drawers in hide 26 invecchiato with mat brown nickel handles, led lighting with dimmer. Onda pouf with cover in removable velvet Persia 2006 prugna. Carpet Dama. Below: close up of the built-in Sydney handle in carbone mat lacquer. Interior in spessart oak melamine, drawers in fumé reflecting glass with edge and Track handle in mat ardesia, upper shelf in techno leather 05 latte and mat ardesia frame.

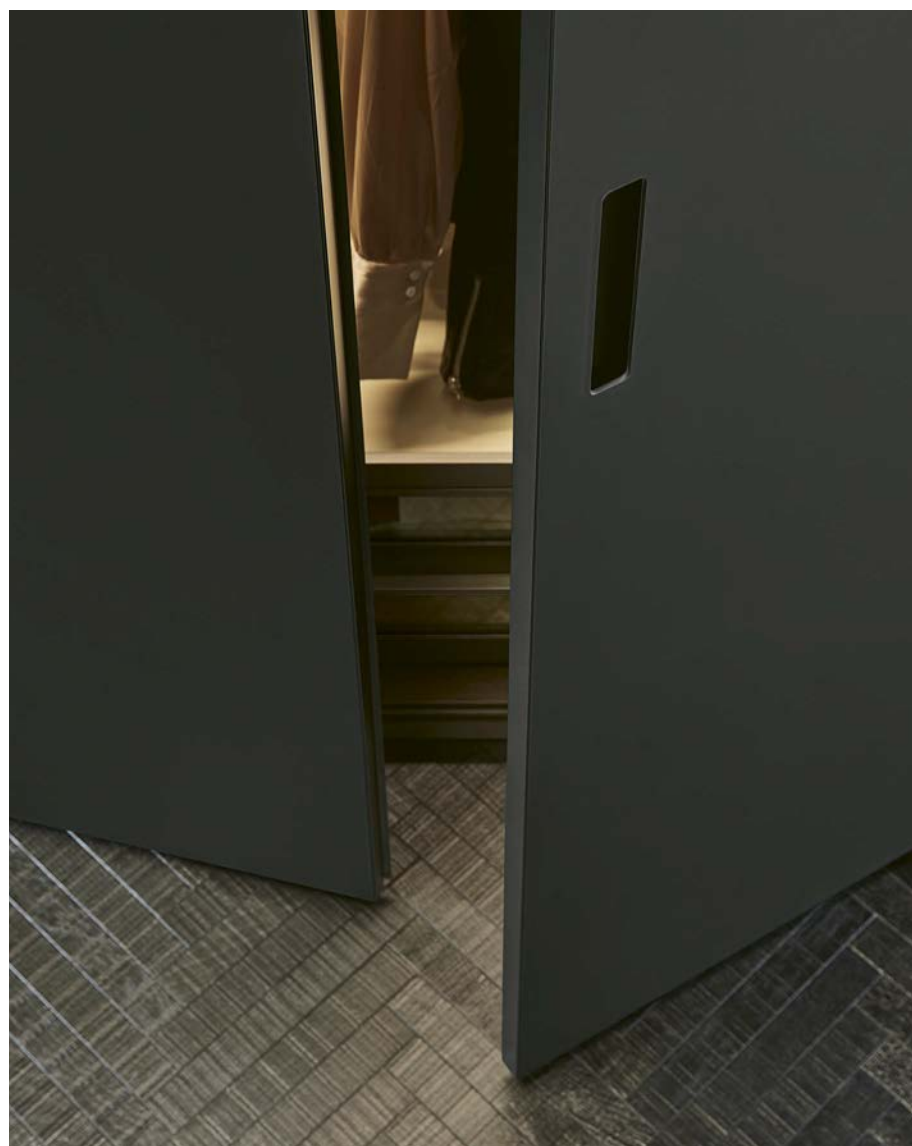



In questa pagina: armadio Senzafine Fitted con ante battenti in vetro fumé e telaio laccato opaco carbone. Interno in nobilitato rovere spessart, con luce led integrata. Armadio Senzafine Ocean con ante battenti in vetro satinato nero e telaio laccato opaco carbone, maniglie Sydney a incasso laccato opaco carbone. Panca Home Hotel in olmo nero. Tappeto Dama. Sotto: dettaglio della maniglia Fitted laccato opaco carbone.

This page: wardrobe Senzafine Fitted with leaf doors in fumé glass and carbone mat lacquered frame. Interior in spessart oak melamine, integrated led light. Wardrobe Senzafine Ocean with leaf doors in mat glass nero and carbone mat lacquered frame, built-in Sydney handles in carbone mat lacquer. Home Hotel bench in black elm. Carpet Dama. Below: close up of the Fitted handle in mat lacquer carbone.



Senzafine Ocean

h 2590 p 609
 Apertura: battente.
 Ante: vetro satinato nero 1303 con telaio laccato opaco carbone, interno laccato opaco carbone.
 Maniglie: Sydney a incasso, laccato opaco carbone.
 Fianchi laterali: laccato opaco carbone.
 Struttura: nobilitato rovere spessart.
 Schienali: nobilitato rovere spessart.
 Attrezzatura: nobilitato rovere spessart, vetro riflettente fumé 5059, tecnopelle 05 latte.
 Parti metalliche: ardesia opaco.

Senzafine Ocean

h 102" d 24"
 Opening: leaf doors.
 Doors: mat glass nero 1303 with carbone mat lacquered profile, mat lacquered carbone inner side.
 Handles: Sydney built-in, mat lacquer carbone.
 Lateral sides: mat lacquer carbone.
 Structure: spessart oak melamine.
 Backs: spessart oak melamine.
 Equipment: spessart oak melamine, fumé reflecting glass 5059, techno leather 05 latte.
 Metal parts: mat ardesia.

Senzafine Fitted

h 2590 p 612
 Apertura: battente.
 Ante: vetro fumé 3050 con telaio laccato opaco carbone.
 Maniglie: Fitted laccato opaco carbone.
 Fianchi laterali: laccato opaco carbone.
 Struttura: nobilitato rovere spessart.
 Schienali: nobilitato rovere spessart.
 Attrezzatura: nobilitato rovere spessart, vetro fumé 3050.
 Parti metalliche: ardesia opaco.

Senzafine Fitted

h 102" d 24"
 Opening: leaf doors.
 Doors: fumé glass 3050 with carbone mat lacquered frame.
 Handles: Fitted carbone mat lacquer.
 Lateral sides: carbone mat lacquer.
 Structure: spessart oak melamine.
 Backs: spessart oak melamine.
 Equipment: spessart oak melamine, fumé glass 3050.
 Metal parts: mat ardesia.

Quid integrato
 Pannelli boiserie: olmo nero.
 Bacheche: laccato opaco carbone.
 Cassetti: cuoio 26 invecchiato, maniglie brown nickel opaco.
 Ripiani: vetro trasparente 1000.

Quid integrated system
 Wall panelling: black elm.
 Open display cases: mat lacquer carbone.
 Drawers: hide 26 invecchiato, glossy brown nickel handles.
 Shelves: transparent glass 1000.

Senzafine Ocean
 Design R&D Poliform

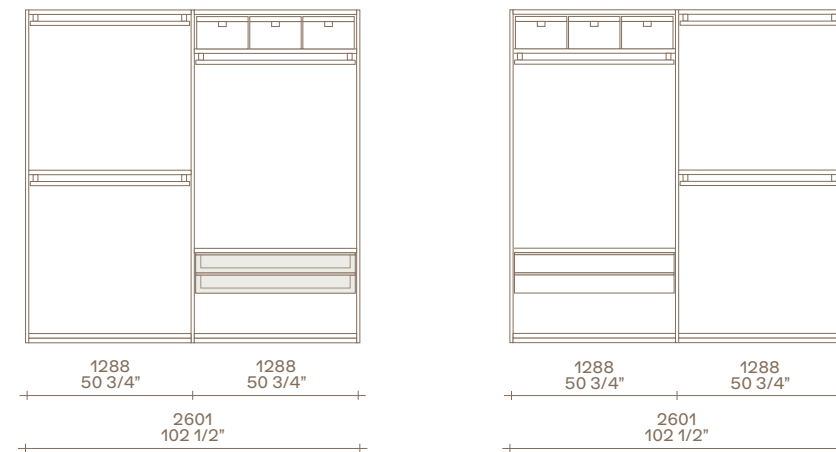

Senzafine Fitted
 Design Rodolfo Dordoni

Quid
 Design R&D Poliform

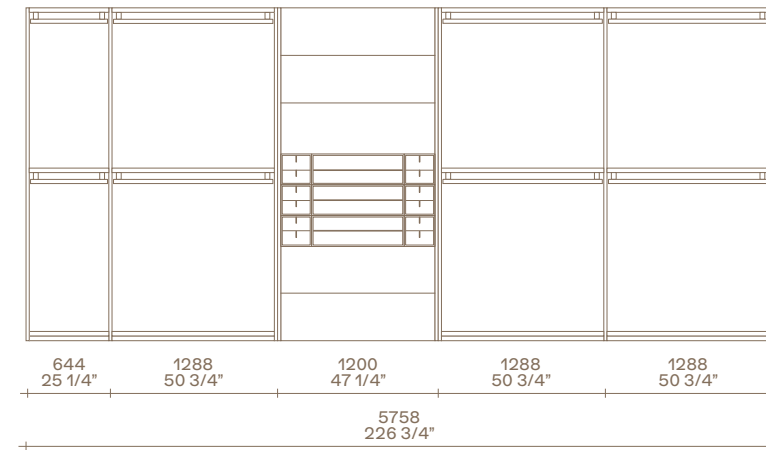

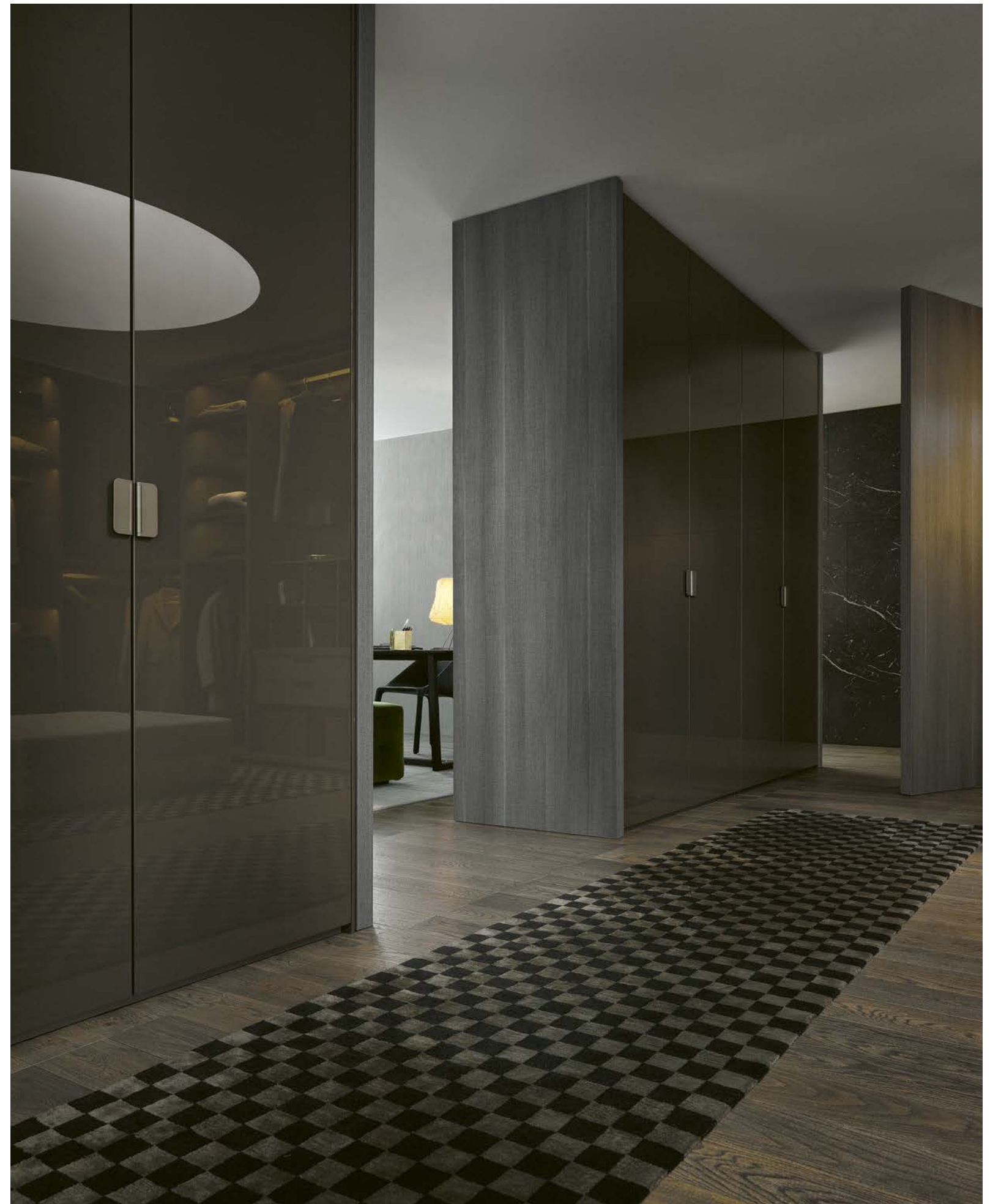





Nelle pagine precedenti: armadi Senzafine New Entry con ante battenti in laccato lucido moka e maniglie Volo ardesia opaco. Letto Dream con pannellatura a muro, rivestimento sfoderabile in pelle Special 40 ardesia e velluto Persia 1404 carbone. Comodini Dream in laccato lucido moka. Tappeti Dama e Soft. A sinistra: dettaglio del cassetto in nobilitato rovere cenere con fondo rivestito in tecnopelle 01 elefante, ripiano in tecnopelle 01 elefante con telaio ardesia opaco. Sotto: dettaglio delle maniglie Volo ardesia opaco.

Previous pages: wardrobes Senzafine New Entry with leaf doors in moka glossy lacquer and Volo handles mat ardesia. Dream bed with wall panelling, removable cover in leather Special 40 ardesia and velvet Persia 1404 carbone. Dream night tables in moka glossy lacquer. Carpets Dama and Soft. To the left: close up of the drawer in cenere oak melamine with bottom covered in techno leather 01 elefante, shelf in techno leather 01 elefante with frame mat ardesia. Below: close up of the Volo handles in mat ardesia.



In questa pagina: armadio Senzafine New Entry con ante battenti in laccato lucido moka e maniglie Volo ardesia opaco. Interno in nobilitato rovere cenere, ripiani portascarpe inclinati in nobilitato rovere cenere con bordi in ardesia opaco e luce led integrata.

This page: wardrobe Senzafine New Entry with leaf doors in moka glossy lacquer and Volo handles mat ardesia. Interior in cenere oak melamine, inclined shoe shelves in cenere oak melamine with edges in mat ardesia and integrated led light.



INTERIOR 10

Senzafine New Entry

h 2590 p 609

Apertura: battente.

Ante: laccato lucido moka.

Maniglie: Volo ardesia opaco.

Fianchi laterali: laccato lucido moka.

Struttura: nobilitato rovere cenere.

Schienali: nobilitato rovere cenere.

Attrezzatura: nobilitato rovere cenere,
tecnopelle 01 elefante.

Parti metalliche: ardesia opaco.

Senzafine New Entry

h 102" d 24"

Opening: leaf doors.

Doors: moka glossy lacquer.

Handles: Volo mat ardesia.

Lateral sides: moka glossy lacquer.

Structure: cenere oak melamine.

Backs: cenere oak melamine.

Equipment: cenere oak melamine,
techno leather 01 elefante.

Metal parts: mat ardesia.

Senzafine New Entry

Design R&D Poliform

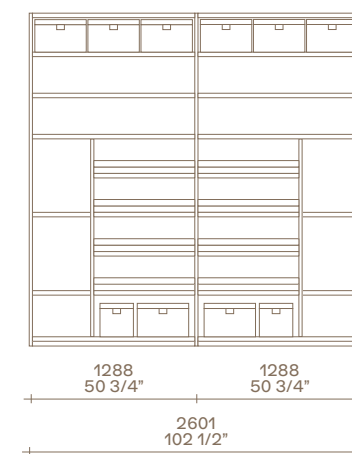
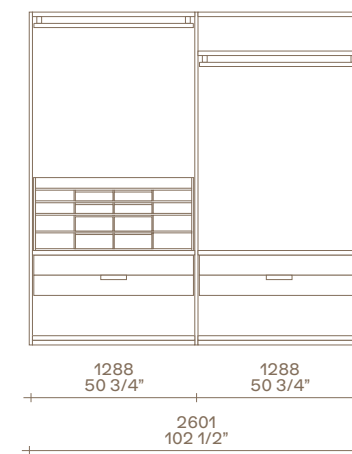

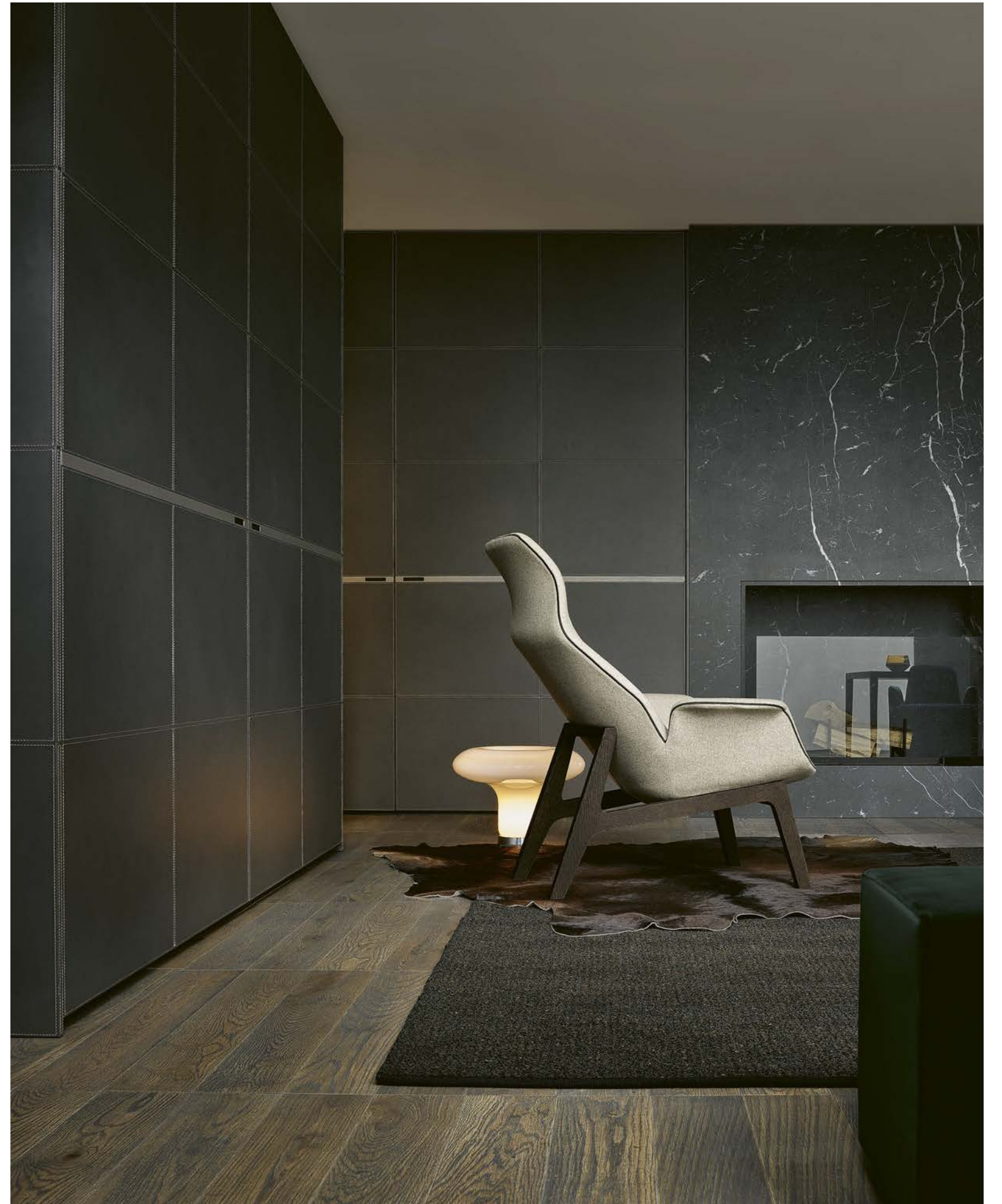





Qui e nelle pagine precedenti: armadi Senzafine Bangkok con ante scorrevoli complanari in cuoio 03 grigio scuro con profili maniglie ardesia opaco. Poltrona Ventura Lounge in tessuto sfoderabile Norway 08 avorio e cuciture a cordoncino nero, struttura in rovere spessart. Sedia Guest in velluto non sfoderabile Persia 2012 visone. Tavolino Tribeca con struttura in brown nickel opaco e piano in marmo calacatta oro lucido. Pouf Play in velluto sfoderabile Persia 1402 muschio. Sotto: dettaglio dell'anta scorrevole complanare Bangkok, rivestita in cuoio 03 grigio scuro con cuciture a vista e profilo maniglia ardesia opaco.

This and previous pages: wardrobes Senzafine Bangkok with coplanar sliding doors in hide 03 grigio scuro with handle profiles mat ardesia. Ventura Lounge armchair in removable fabric Norway 08 avorio and nero drawstring stitchings, structure in spessart oak. Guest chair in non-removable velvet Persia 2012 visone. Tribeca coffee table with structure in mat brown nickel and top in glossy marble calacatta oro. Play pouf in removable velvet Persia 1402 muschio. Below: close up of the coplanar sliding door Bangkok covered in hide 03 grigio scuro with visible stitchings and handle profile mat ardesia.





Qui e nella pagina precedente: armadi Senzafine Bangkok con ante scorrevoli complanari in cuoio 03 grigio scuro con profili maniglie ardesia opaco. Sedia Guest in velluto non sfoderabile Persia 2012 visone. Cabina armadio Ubik con pannelli a parete vetro acidato bronzo, attrezzature in nobilitato rovere cenere. A destra: dettaglio dei vassoi estraibili in nobilitato rovere cenere con piano in tecnopelle 01 elefante.

This and previous page: wardrobes Senzafine Bangkok with coplanar sliding doors in hide 03 grigio scuro with mat ardesia handle profiles. Guest chair in non-removable velvet Persia 2012 visone. Ubik walk-in closet with etched glass bronzo wall mounted panels, equipment in cenere oak melamine. To the right: close up of the pull out trays in cenere oak melamine with shelf in techno leather 01 elefante.



INTERIOR 11

Senzafine Bangkok

h 2590 p 614

Apertura: scorrevole complanare.

Ante: cuoio 03 grigio scuro.

Profili maniglia: ardesia opaco.

Fianchi laterali: cuoio 03 grigio scuro.

Struttura: nobilitato rovere cenere.

Schienali: nobilitato rovere cenere.

Attrezzatura: nobilitato rovere cenere,
vetro riflettente fumé 5059, tecnopelle
01 elefante.

Parti metalliche: ardesia opaco.

Senzafine Bangkok

h 102" d 24 1/4"

Opening: coplanar sliding doors.

Doors: hide 03 grigio scuro.

Handle profiles: mat ardesia.

Lateral sides: hide 03 grigio scuro.

Structure: cenere oak melamine.

Backs: cenere oak melamine.

Equipment: cenere oak melamine,
fumé reflecting glass 5059, techno
leather 01 elefante.

Metal parts: mat ardesia.

Senzafine Bangkok Design Operadesign

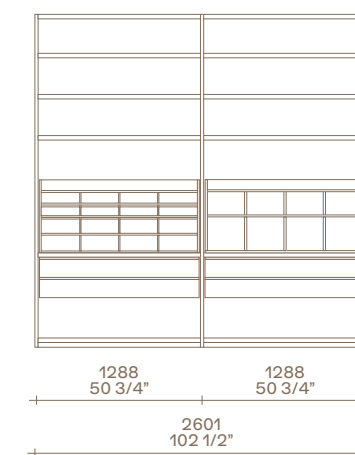
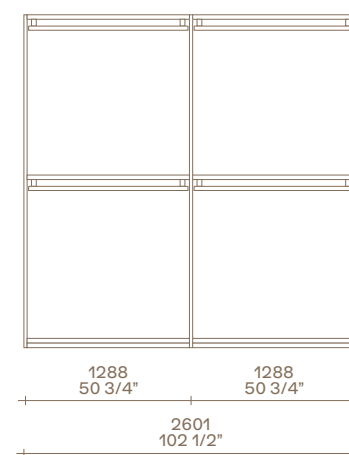
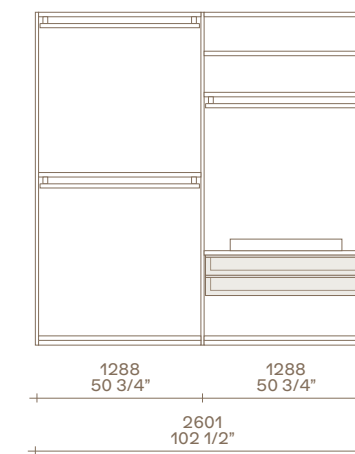
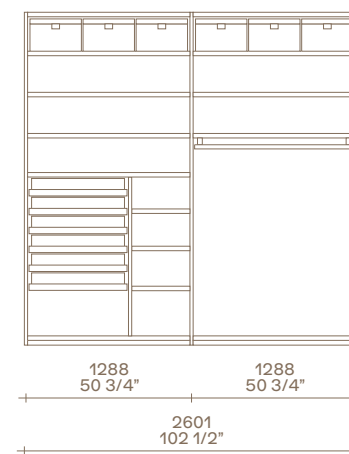

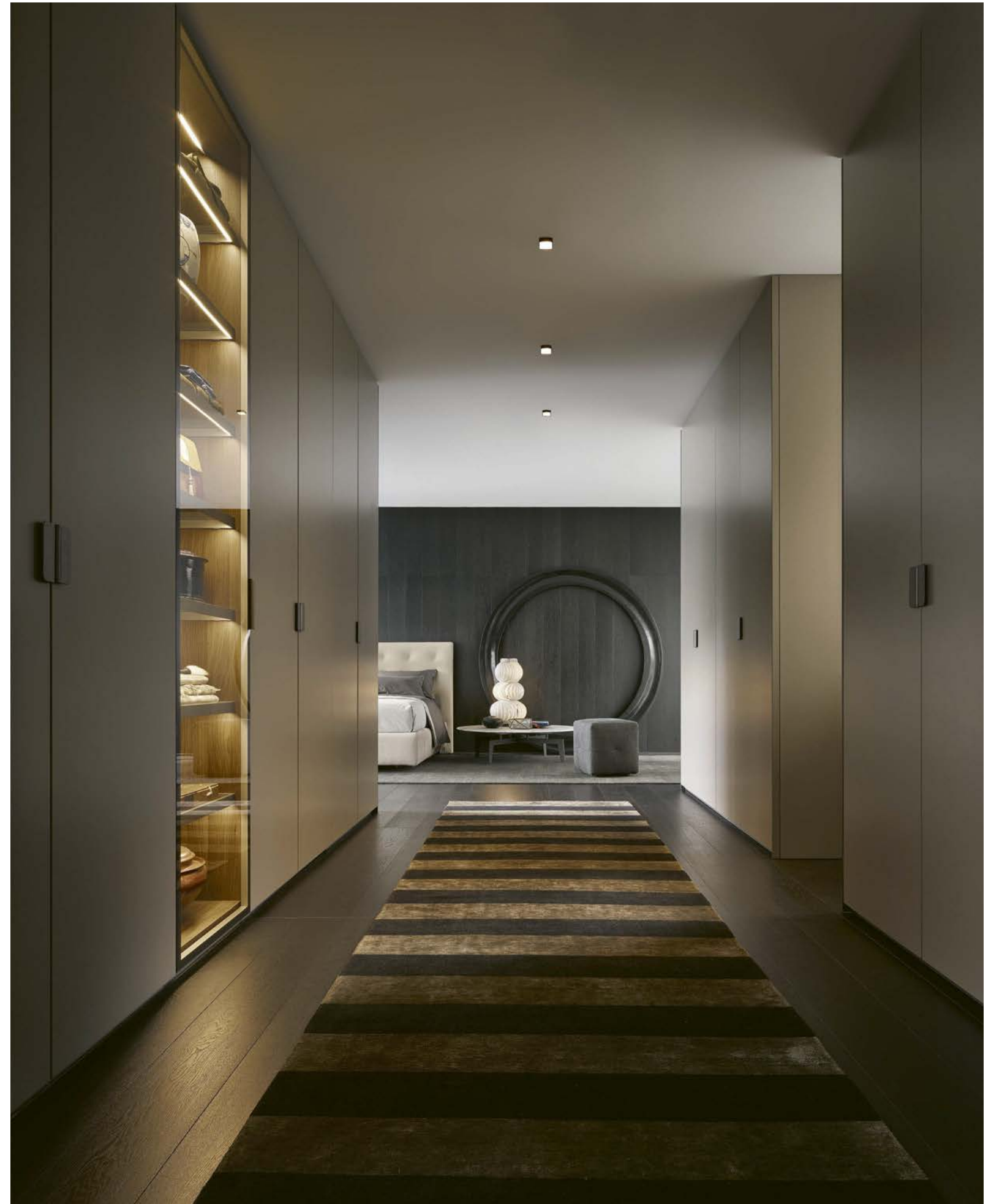





Qui e nelle pagine precedenti: armadio Senzafine New Entry con ante battenti in laccato opaco arena e maniglie Volo ardesia opaco. Anta centrale Fitted in vetro trasparente riflettente e telaio ardesia opaco. Interno in nobilitato noce c. e luce led integrata. Letto Arca in pelle sfoderabile Nabuk 01 latte. Tavolino Tribeca in brown nickel opaco con piano in marmo calacatta oro lucido. Pouf Onda in tessuto sfoderabile Arcadia 09 grafite. Tappeto Stripes. A sinistra: dettaglio del tubo appendiabiti rivestito in tecnopelle 01 elefante e ardesia opaco, ripiano in nobilitato noce c. con telaio ardesia opaco. Sotto: dettaglio dei ripiani in vetro fumé con telaio ardesia opaco e luce led integrata.

This and previous pages: wardrobe Senzafine New Entry with leaf doors in arena mat lacquer and handles Volo mat ardesia. Central door Fitted in transparent reflecting glass and mat ardesia frame. Interior in walnut c. melamine and integrated led light. Arca bed in removable leather Nabuk 01 latte. Tribeca coffee table in mat brown nickel with top in glossy marble calacatta oro. Onda pouf in removable fabric Arcadia 09 grafite. Carpet Stripes. To the left: close up of the hanging bar covered in techno leather 01 elefante and mat ardesia, shelf in walnut c. melamine with mat ardesia frame. Below: close up of the shelves in fumé glass with mat ardesia frame and integrated led light.



In questa pagina: armadio Senzafine New Entry con ante battenti in laccato opaco arena e maniglie Volo ardesia opaco, anta centrale Fitted in vetro trasparente riflettente e telaio ardesia opaco. Cabina armadio Senzafine con struttura in nobilitato noce c. e fianchi a telaio in ardesia opaco. Cassetti in nobilitato noce c. e maniglia Track in ardesia opaco. Ripiani in nobilitato noce c. e in vetro fumé con telaio ardesia opaco. Tappeto Stripes.

This page: wardrobe Senzafine New Entry with leaf doors in arena mat lacquer and Volo handles mat ardesia, central door Fitted in transparent reflecting glass and mat ardesia frame. Walk-in closet Senzafine with structure in walnut c. melamine and mat ardesia frame sides. Drawers in walnut c. melamine and mat ardesia Track handle. Shelves in walnut c. melamine and in glass fumé with mat ardesia frame. Carpet Stripes.



INTERIOR 12

Senzafine New Entry

h 2590 p 609
 Apertura: battente.
 Ante: laccato opaco arena.
 Maniglie: Volo ardesia opaco.
 Fianchi laterali: laccato opaco arena.
 Struttura: nobilitato noce c.
 Schienali: nobilitato noce c.
 Attrezzatura: nobilitato noce c., tecnopelle 01 elefante.
 Parti metalliche: ardesia opaco.

Senzafine Fitted

Apertura: battente.
 Ante: vetro trasparente riflettente 5000 con telaio ardesia opaco.
 Maniglie: Fitted ardesia opaco.
 Struttura: nobilitato noce c.
 Schienali: nobilitato noce c.
 Attrezzatura: nobilitato noce c., vetro fumé 3050.
 Parti metalliche: ardesia opaco.

Senzafine cabina armadio

h 2590 p 584
 Struttura: nobilitato noce c.
 Schienali: nobilitato noce c.
 Fianco telaio centrale: ardesia opaco.
 Attrezzatura: nobilitato noce c., vetro fumé 3050.
 Parti metalliche: ardesia opaco.

Senzafine New Entry

h 102" d 24"
 Opening: leaf doors.
 Doors: arena mat lacquer.
 Handles: Volo mat ardesia.
 Lateral sides: arena mat lacquer.
 Structure: walnut c. melamine.
 Backs: walnut c. melamine.
 Equipment: walnut c. melamine, techno leather 01 elefante.
 Metal parts: mat ardesia.

Senzafine Fitted

Opening: leaf doors.
 Doors: transparent reflecting glass 5000 with mat ardesia frame.
 Handles: Fitted mat ardesia.
 Structure: walnut c. melamine.
 Backs: walnut c. melamine.
 Equipment: walnut c. melamine, fumé glass 3050.
 Metal parts: mat ardesia.

Senzafine walk-in closet

h 102" d 23"
 Structure: walnut c. melamine.
 Backs: walnut c. melamine.
 Central frame side: mat ardesia.
 Equipment: walnut c. melamine, fumé glass 3050.
 Metal parts: mat ardesia.

Senzafine New Entry

Design R&D Poliform

Senzafine Fitted

Design Rodolfo Dordoni

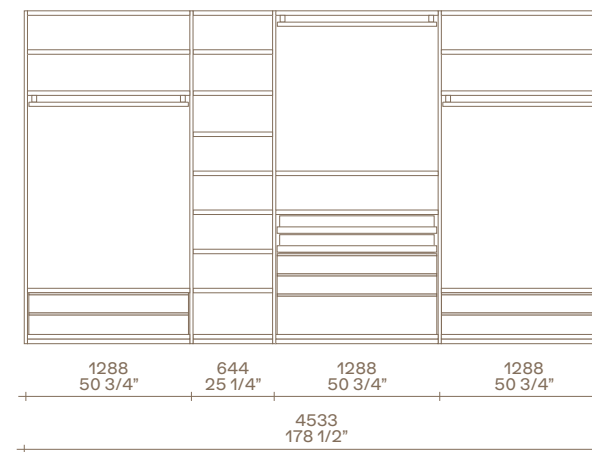

Senzafine New Entry

Design R&D Poliform

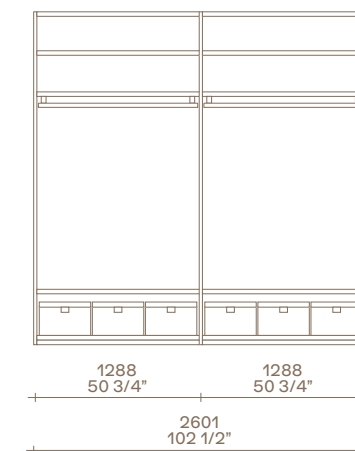
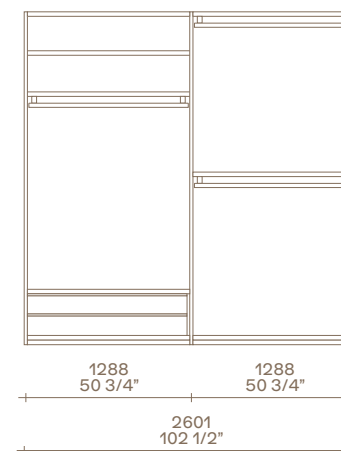

Senzafine walk-in closet

Design R&D Poliform

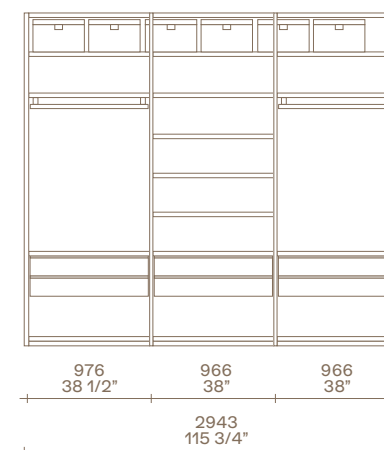

SENZAFINE WALK-IN CLOSET

La cabina armadio Senzafine reinterpreta il sistema armadio in modo leggero ed elegante senza rinunciare alla solidità, assicurata dai fianchi più spessi. Senza ante, i volumi di contenimento sono aperti e offrono la massima libertà di configurazione. Le finiture sono protagoniste, così come l'attrezzatura interna, da scegliere in base alle necessità combinando tubi appendiabiti, cassettiere, ripiani e vassoi estraibili.

The Senzafine walk-in closet reinterprets the wardrobe system with a light and elegant approach without sacrificing solidity, ensured by the thicker sides. Without doors, the storage volumes are open and offer maximum configuration freedom. The finishes are the protagonists, as is the internal equipment, to be chosen according to need by combining closet rods, chests of drawers, shelves, and pull-out trays.



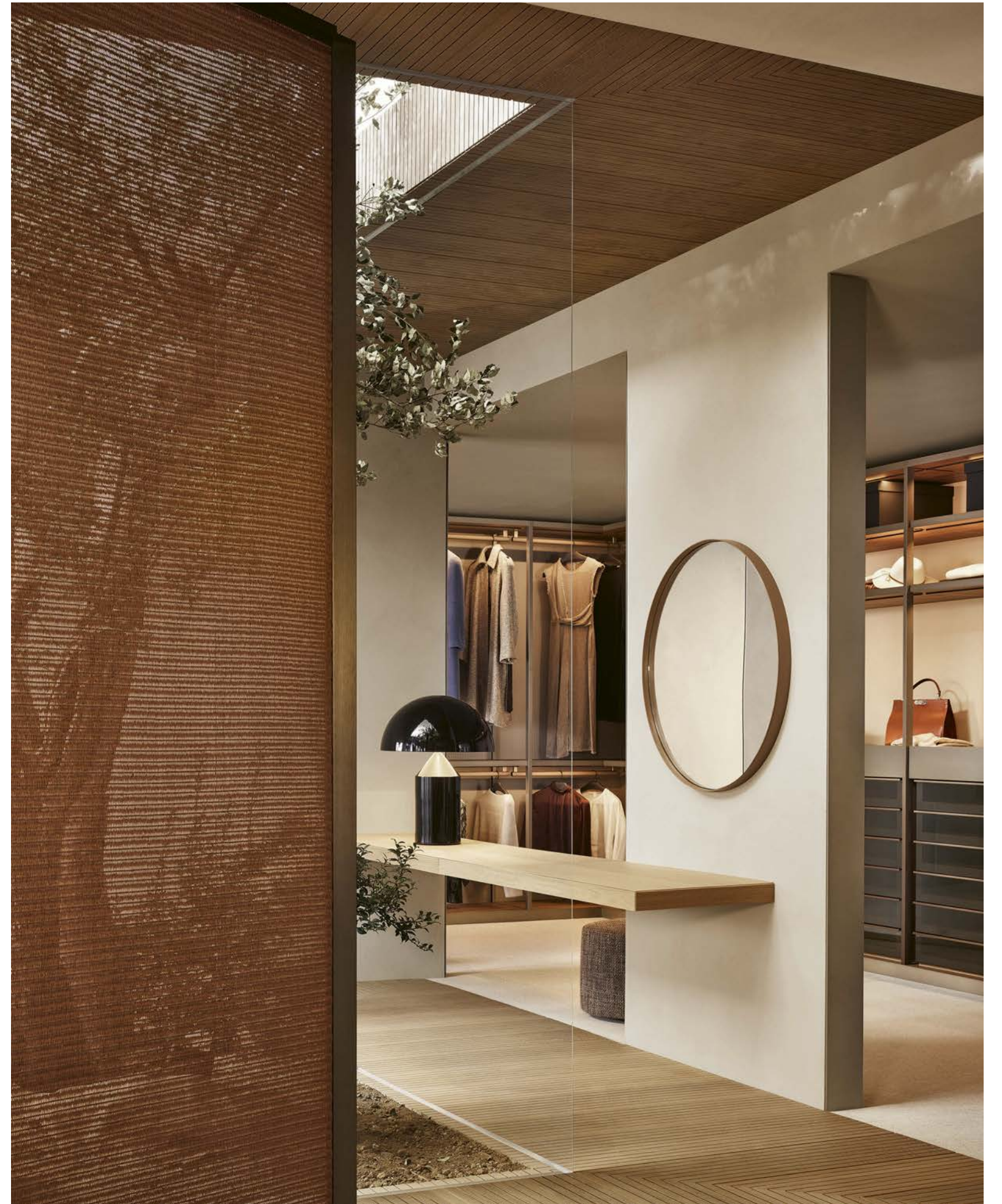



Qui, nelle pagine precedenti e successive: cabina armadio Senzafine con struttura in nobilitato olmo, fianchi a telaio, bordi e fascia zoccolo in champagne opaco, schienali in metacrilato roller latte. Ripiani superiori in nobilitato olmo e frontale champagne opaco, luce led integrata. Tubi appendiabiti rivestiti in tecnopelle 06 nocciola e champagne opaco. Ripiani inferiori in tecnopelle 06 nocciola con telaio champagne opaco. Cassettiere a vetrina con piano superiore in vetro fumé, cassetto con frontale a smusso in laccato opaco champagne e piano in tecnopelle 06 nocciola. Cassetti inferiori in nobilitato olmo e in vetro riflettente fumé con maniglia Track champagne opaco. Pouf New York in tessuto sfoderabile Antea 05 terra di siena. Specchio Circle con cornice in cuoio 26 invecchiato e specchio bianco. Poltrona Santa Monica in velluto sfoderabile Tebe 11 bruciato.

Here, previous and next pages: Senzafine walk-in closet with structure in elm melamine, frame sides, edges and plinth filler in mat champagne, backs in methacrylate roller latte. Upper shelves in elm melamine and front in mat champagne, integrated led light. Hanging rails covered in techno leather 06 nocciola and mat champagne. Lower shelves in techno leather 06 nocciola with mat champagne frame. Display case chests of drawers with top in glass fumé, drawer with front with chamfered edge mat lacquered champagne and shelf in techno leather 06 nocciola. Lower drawers in elm melamine and in fumé reflecting glass with mat champagne Track handle. New York pouf in removable fabric Antea 05 terra di siena. Circle mirror with frame in hide 26 invecchiato and white mirror. Santa Monica armchair in removable velvet Tebe 11 bruciato.







A sinistra: cabina armadio Senzafine con struttura in nobilitato olmo, fianchi a telaio in champagne opaco, schienali in metacrilato roller latte. Ripiani superiori in nobilitato olmo e frontale champagne opaco, luce led integrata. Tubi appendiabiti rivestiti in tecnopelle 06 nocciola e champagne opaco. Cassettiere a vetrina in laccato opaco champagne e cassetti inferiori in vetro riflettente fumé con maniglia Track champagne opaco. Poltrona Santa in velluto sfoderabile Tebe 11 bruciato. Tavolino Nara in legno massello noce gold. Armadio Senzafine Cover con ante battenti in tecnopelle 05 latte e profili champagne opaco. Sotto: dettaglio della cassettiere a vetrina con piano superiore in vetro fumé, piano in tecnopelle 06 nocciola e luce led integrata, ripiano in tecnopelle 06 nocciola con telaio champagne opaco.

To the left: Senzafine walk-in closet with structure in elm melamine, frame sides in mat champagne, backs in methacrylate roller latte. Upper shelves in elm melamine and mat champagne front, integrated led light. Hanging rails covered in techno leather 06 nocciola and mat champagne. Display case chests of drawers in mat lacquered champagne and lower drawers in fumé reflecting glass with mat champagne Track handle. Santa Monica armchair in removable velvet Tebe 11 bruciato. Nara coffee table in solid wood gold walnut. Wardrobe Senzafine Cover with leaf doors in techno leather 05 latte and mat champagne profiles. Below: close up of the display case chest of drawers with top in fumé glass, shelf in techno leather 06 nocciola and integrated led light, next to it, shelf in techno leather 06 nocciola with mat champagne frame.

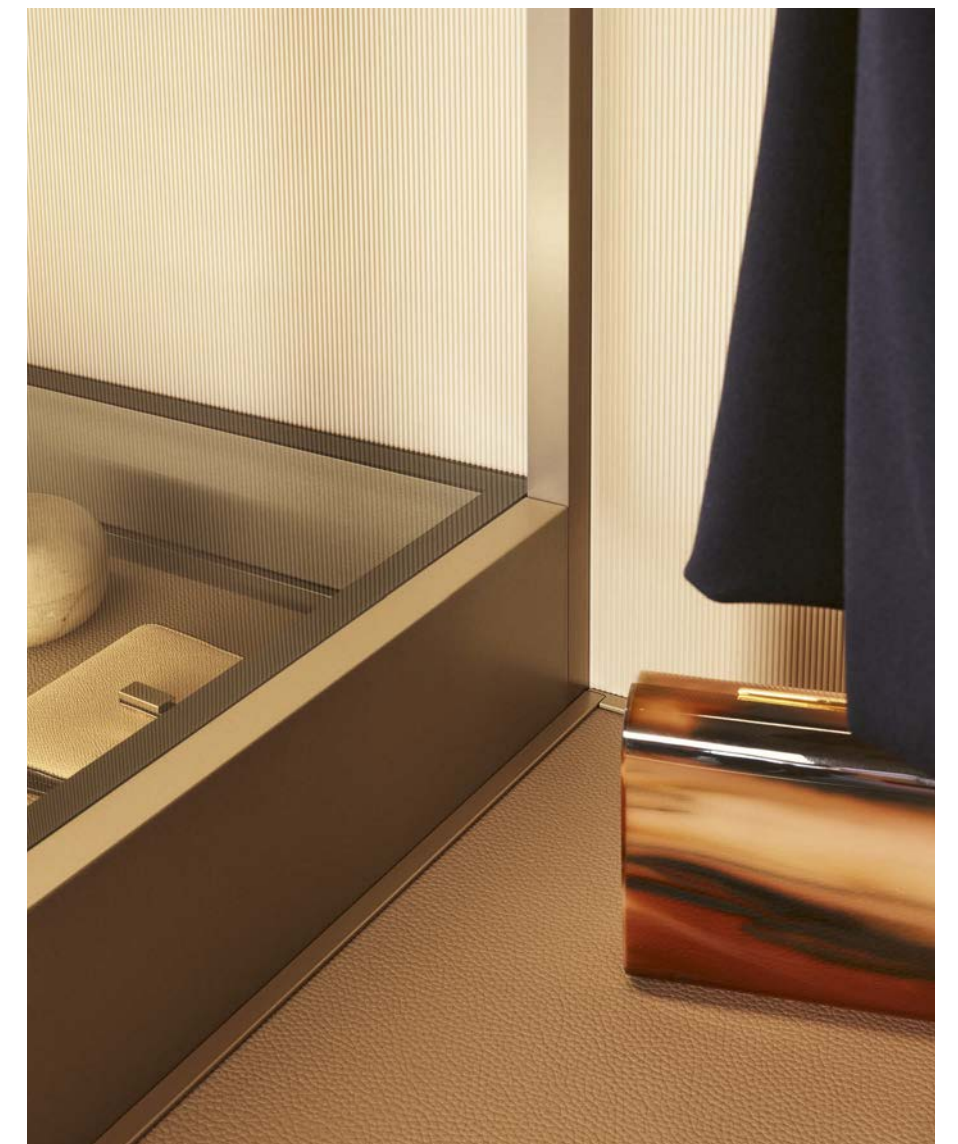

INTERIOR 13

Senzafine cabina armadio

h 2590 p 584

Struttura: nobilitato olmo.

Schienali: metacrilato roller latte.

Fianco telaio: champagne opaco.

Attrezzatura: nobilitato olmo, vetro fumé

3050, vetro riflettente fumé 5059,

tecnopelle 06 nocciola.

Parti metalliche: champagne opaco.

Senzafine walk-in closet

h 102" d 23"

Structure: elm melamine.

Backs: methacrylate roller latte.

Frame side: mat champagne.

Equipment: elm melamine, fumé glass

3050, fumé reflecting glass 5059,

techno leather 06 nocciola.

Metal parts: mat champagne.

Senzafine

Design R&D Poliform

Cassetiera a vetrina - Showcase chest of drawers

Design Rodolfo Dordoni

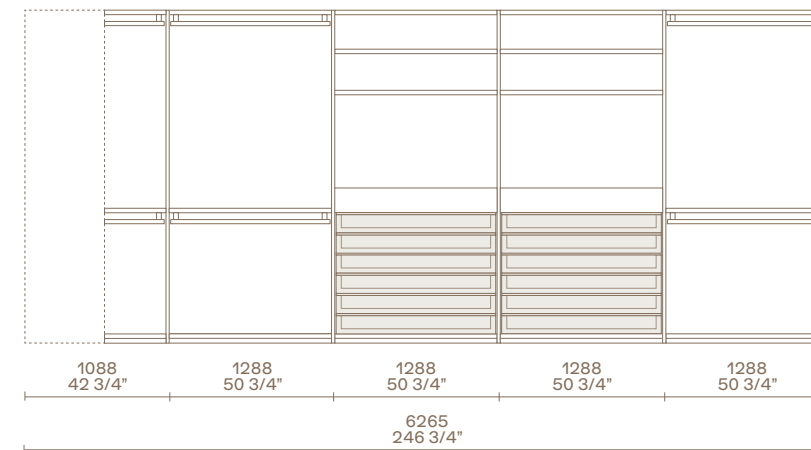
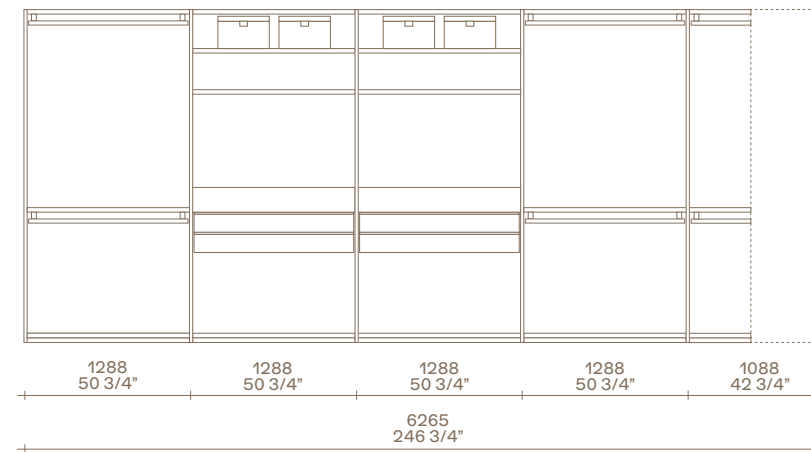







Nelle pagine precedenti e nella successiva: cabina armadio Senzafine con struttura in nobilitato ardesia e schienali in metacrilato roller latte, fianchi a telaio in ardesia opaco e luce led integrata. Ripiani superiori in nobilitato ardesia e tecnopelle 05 latte con telaio ardesia opaco, scatole con coperchio rivestite in tessuto ardesia. Al centro, ante battenti Fitted in vetro trasparente riflettente con telaio e maniglie in ardesia opaco. Cassettiera a isola Set-up con struttura in laccato opaco ardesia e piano superiore in vetro fumé e tecnopelle 05 latte, cassetti con frontali in vetro riflettente fumé, maniglia Track ardesia opaco. Vano a giorno con ripiano in vetro fumé, ripiano e fondo cassetti in tecnopelle 05 latte. Pouf Henry in olmo nero e seduta in pelle non sfoderabile Nabuk 09 ruggine. Tappeto Tratto ruggine. Poltrona Jane Large in tessuto sfoderabile Sendai 03 fango e basamento in olmo nero. A sinistra: dettaglio delle cassettiere a vetrina con piano superiore in vetro fumé, cassetto con frontale a smusso in laccato opaco ardesia e piano in tecnopelle 05 latte. Cassetti inferiori con frontali in vetro riflettente fumé con bordo e maniglia Track in ardesia opaco, piani in tecnopelle 05 latte.

Previous and next pages: Senzafine walk-in closet with structure in ardesia melamine and backs in methacrylate roller latte, frame sides in mat ardesia and integrated led light. Upper shelves in melamine ardesia and techno leather 05 latte with mat ardesia frame, boxes with lid covered in fabric ardesia. In the centre, Fitted leaf doors in transparent reflecting glass with frame and handles in mat ardesia. Set-up island chest of drawers with structure in ardesia mat lacquer and upper shelf in fumé glass and techno leather 05 latte, drawers with fronts in fumé reflecting glass, mat ardesia Track handle. Open compartment with shelf in fumé glass, shelf and drawers bottom in techno leather 05 latte. Henry pouf in black elm, seat in non-removable leather Nabuk 09 ruggine. Carpet Tratto ruggine. Jane Large armchair in removable fabric Sendai 03 fango and black elm base. To the left: close up of the showcase chests of drawers with top in fumé glass, drawer with bevelled front in ardesia mat lacquer and shelf in techno leather 05 latte. Lower drawers with fronts in fumé reflecting glass, edge and Track handle in mat ardesia, shelves in techno leather 05 latte.



In questa pagina: dettaglio del fianco a telaio in ardesia opaco e dello schienale in metacrilato roller latte. Ripiano in tecnopelle 05 latte con telaio in ardesia opaco e tubo appendiabiti rivestito in tecnopelle 05 latte e ardesia opaco.

This page: close up of the frame side in mat ardesia and of the back in methacrylate roller latte. Shelf in techno leather 05 latte with frame in mat ardesia, hanging bar covered in techno leather 05 latte and mat ardesia.



INTERIOR 14

Senzafine cabina armadio

h 2590 p 584
Struttura: nobilitato ardesia.
Schienali: metacrilato roller latte.
Fianco telaio centrale: ardesia opaco.
Attrezzatura: nobilitato ardesia, vetro fumé 3050, vetro riflettente fumé 5059, tecnopelle 05 latte.
Parti metalliche: ardesia opaco.

Fitted ante

Apertura: battente.
Ante: vetro trasparente riflettente 5000 con telaio ardesia opaco.
Maniglie: Fitted ardesia opaco.

Senzafine walk-in closet

h 102" d 23"
Structure: ardesia melamine.
Backs: methacrylate roller latte.
Central frame side: mat ardesia.
Equipment: ardesia melamine, fumé glass 3050, fumé reflecting glass 5059, techno leather 05 latte.
Metal parts: mat ardesia.

Fitted doors

Opening: leaf doors.
Doors: transparent reflecting glass 5000 with mat ardesia frame.
Handles: Fitted mat ardesia.

Senzafine

Design R&D Poliform

Fitted

Design Rodolfo Dordoni

Cassettiera a vetrina - Showcase chest of drawers

Design Rodolfo Dordoni

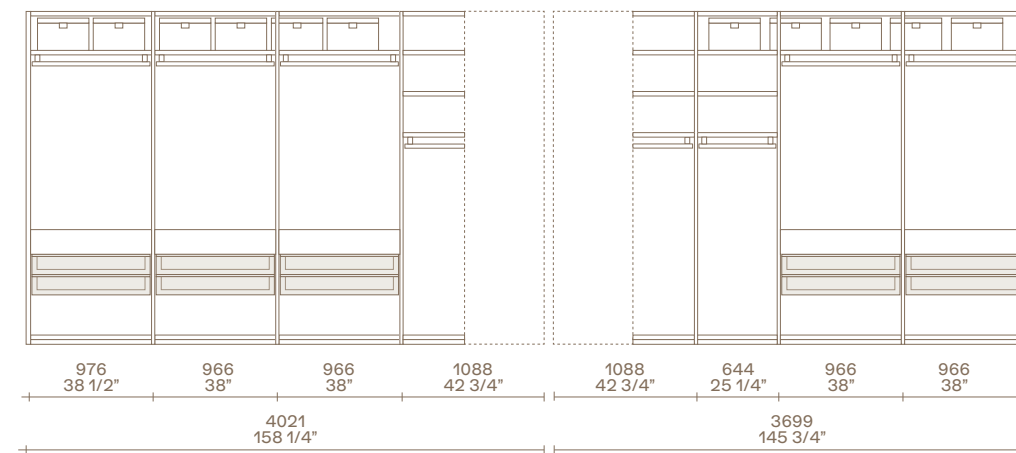





Nelle pagine precedenti: cabina armadio Senzafine con struttura in nobilitato rovere cenere. Ripiani in nobilitato rovere cenere, vetro fumé e tecnopelle 01 elefante con telaio ardesia opaco e luce led integrata. Pouf Gant in pelle non sfoderabile Nabuk 01 latte. Tavolino Tribeca in brown nickel opaco e piano in marmo emperador dark lucido. Tappeto Dama. A destra: dettaglio della cassettiere in nobilitato rovere cenere con maniglie Step, piano superiore in tecnopelle 01 elefante e telaio ardesia opaco. Svuotatasche estraibile in laccato opaco ardesia con piano superiore, vaschette, porta orologi e porta gioielli in pelle grigia. Ripiani in vetro fumé con telaio ardesia opaco. Sotto: dettaglio della maniglia Step in tecnopelle 01 elefante e ardesia opaco.

Previous pages: Senzafine walk-in closet with structure in cenere oak melamine. Shelves in cenere oak melamine, fumé glass and techno leather 01 elefante with frame mat ardesia, integrated led light. Gant pouf in non-removable leather Nabuk 01 latte. Tribeca coffee table in mat brown nickel and top in glossy marble emperador dark. Carpet Dama. To the right: close up of the chests of drawers in melamine cenere oak with Step handles, top shelf in techno leather 01 elefante and mat ardesia frame. Ardesia mat lacquered pull-out jewellery tray with top shelf, open cases, watchcase and jewellery case in grey leather. Shelves in fumé glass with mat ardesia frame. Below: close up of the Step handle in techno leather 01 elefante and mat ardesia.



In questa pagina: dettaglio del vassoio in nobilitato rovere cenere attrezzato con vaschette rivestite in pelle grigia, maniglia Step in tecnopelle 01 elefante e ardesia opaco. Porta pantaloni in nobilitato rovere cenere. Ripiani in tecnopelle 01 elefante con telaio ardesia opaco.

This page: close up of the tray in cenere oak melamine accessorized with cases covered in grey leather, Step handle in techno leather 01 elefante and mat ardesia. Trousers hanger in cenere oak melamine. Shelves in techno leather 01 elefante with mat ardesia frame.



INTERIOR 15

Senzafine cabina armadio

h 2590 p 584
 Struttura: nobilitato rovere cenere.
 Schienali: nobilitato rovere cenere.
 Attrezzatura: nobilitato rovere cenere,
 vetro fumé 3050, tecnopelle
 01 elefante.
 Parti metalliche: ardesia opaco.

Senzafine walk-in closet

h 102" d 23"
 Structure: cenere oak melamine.
 Backs: cenere oak melamine.
 Equipment: cenere oak melamine,
 fumé glass 3050, techno leather
 01 elefante.
 Metal parts: mat ardesia.

Senzafine
 Design R&D Poliform

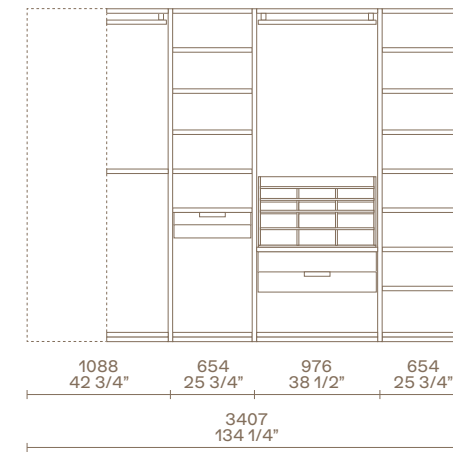
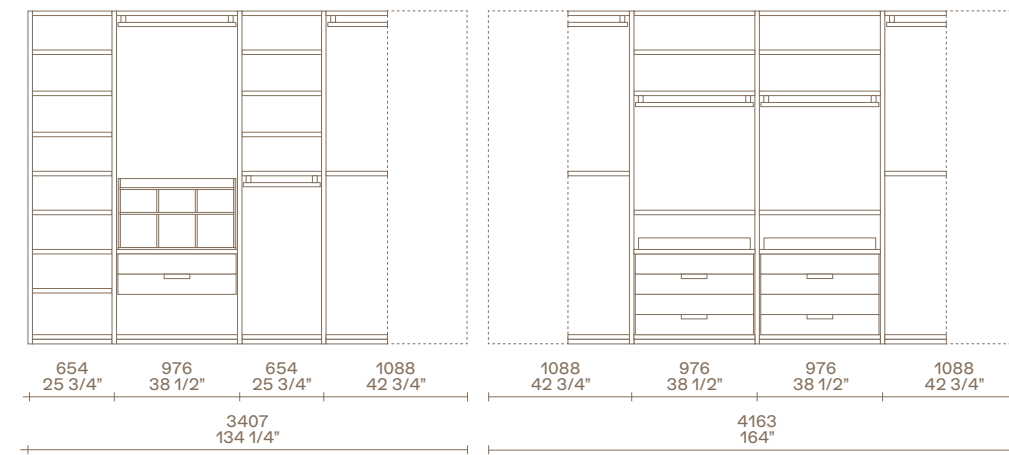



UBIK WALK-IN CLOSET

Ubik è una cabina armadio basata sulla combinazione di boiserie e sistema a cremagliera. Evoluta e leggera, offre al contempo flessibilità e funzionalità, grazie a contenitori e accessori come vassoi, cassetti con frontale legno o cristallo, scarpiera estraibili, portapantaloni e portacamicie da posizionare all'altezza e nell'ordine desiderato. Pressoché infinite le possibilità di configurazione e di personalizzazione delle finiture.

Ubik is a walk-in closet based on the combination of wall paneling and a rack system. Advanced and light, it offers flexibility and functionality at the same time, thanks to containers and accessories such as trays, drawers with wooden or glass fronts, pull-out shoe racks, trouser racks, and shirt racks to be positioned at the height and in the order you desire. The possibilities of configuration and customization of the finishes are basically infinite.







Nelle pagine precedenti e nella successiva: cabina armadio Ubik con pannelli a parete in nobilitato Skin laccato opaco 94 latte, basamenti in nobilitato rovere cenere, zoccolo in ardesia opaco. Ripiani superiori in nobilitato rovere cenere con frontale in ardesia opaco e luce led integrata. Sul ripiano più alto, scatole con coperchio rivestite in tessuto ardesia. Tubi appendiabiti rivestiti in tecnopelle 05 latte e ardesia opaco. Ripiani inferiori in tecnopelle 05 latte con telaio ardesia opaco. Armadio Senzafine Ocean con ante battenti in vetro satinato arena e telaio laccato opaco arena, maniglia Sydney a incasso laccato opaco arena. Pouf New York rivestiti in tessuto sfoderabile Skyros 02 sabbia e in pelle non sfoderabile Soft 10 prugna, entrambi con piedini brown nickel lucido. A destra: dettaglio della cassetiera a vetrina con piano superiore in vetro fumé, cassetto con frontale a smusso laccato opaco ardesia e piano in tecnopelle 05 latte, sul retro del cassetto, un soffietto chiude lo spazio dell'estrazione. Cassetti inferiori con frontali in vetro riflettente fumé con bordo e maniglia Track in ardesia opaco, piani in tecnopelle 05 latte.

Previous and next pages: Ubik walk-in closet with wall mounted panels in 94 latte mat lacquered melamine Skin, bases in cenere oak melamine, plinth in mat ardesia. Upper shelves in cenere oak melamine with front in mat ardesia and integrated led light. On the highest shelf, boxes with lid covered in fabric ardesia. Hanging bars covered in techno leather 05 latte and mat ardesia. Lower shelves in techno leather 05 latte with mar ardesia frame. Wardrobe Senzafine Ocean with leaf doors in mat glass arena and arena mat lacquered frame, Sydney built-in handle in arena mat lacquer. New York pouf covered in removable fabric Skyros 02 sabbia and in non-removable fabric Soft 10 prugna, both with glossy brown nickel feet. To the right: close up of the showcase chest of drawers with top in fumé glass, drawer with beveled front in mat lacquer ardesia and shelf in techno leather 05 latte. At the back of the drawer, a pleated fabric covers the extraction space. Lower drawers with front in fumé reflecting glass with edge and handle Track in mat ardesia, shelves in techno leather 05 latte.







A sinistra: dettaglio del pannello a parete in nobilitato Skin laccato opaco 94 latte e del ripiano in tecnopelle 05 latte con telaio ardesia opaco. Sotto: dettaglio del tubo appendiabiti rivestito in tecnopelle 05 latte e ardesia opaco, ripiano in nobilitato rovere cenere con frontale ardesia opaco e luce led integrata.

To the left: close up of the wall mounted panel in 94 latte mat lacquered Skin melamine and of the shelf in techno leather 05 latte with mat ardesia frame. Below: close up of the hanging rail covered in techno leather 05 latte and mat ardesia, shelf in cenere oak melamine with mat ardesia front and integrated led light.

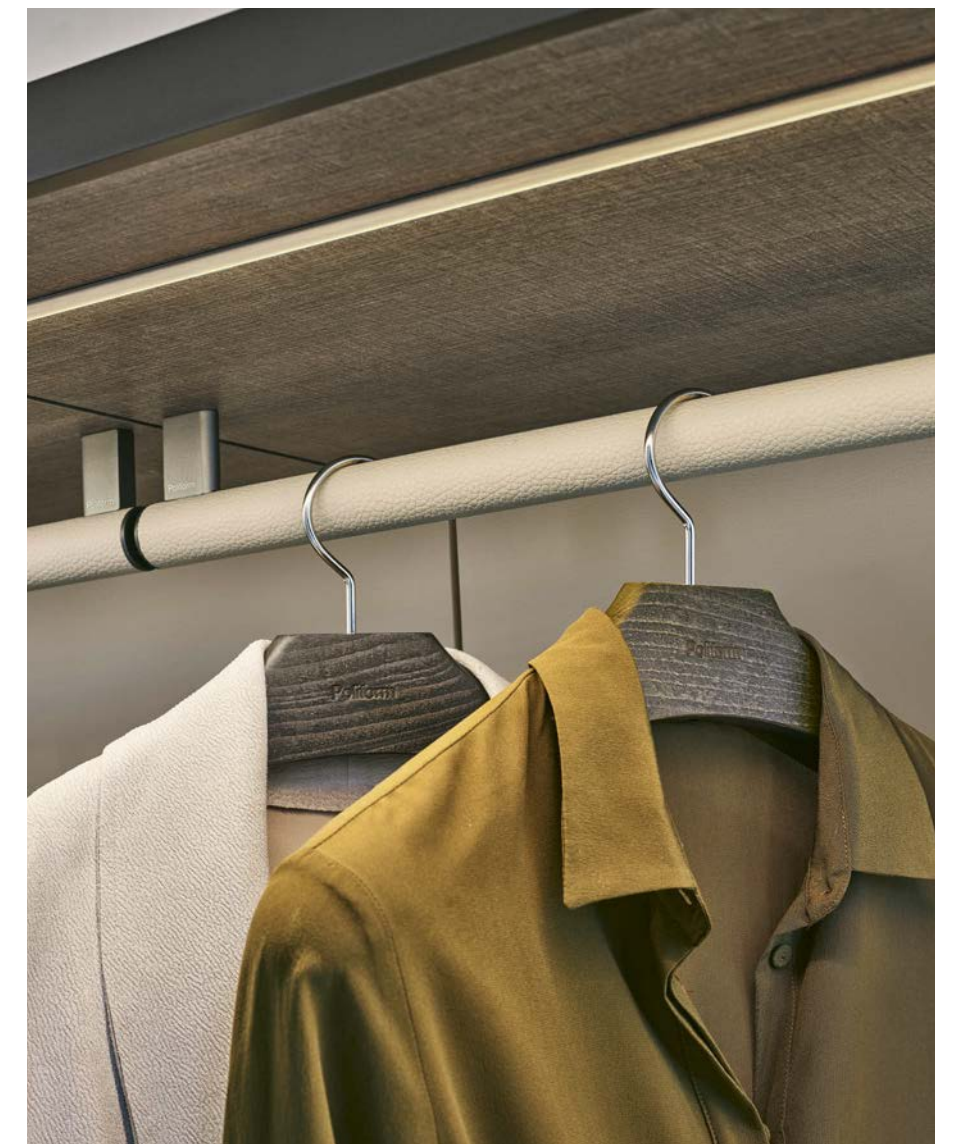

INTERIOR 16

Ubik cabina armadio

h 2590 - 990 p 605
 Pannelli a parete: nobilitato Skin laccato opaco 94 latte.
 Basamenti: nobilitato rovere cenere.
 Attrezzatura: nobilitato rovere cenere, nobilitato ardesia, vetro fumé 3050, vetro riflettente fumé 5059, tecnopelle 05 latte.
 Parti metalliche: ardesia opaco.

Senzafine Ocean

h 2590 p 609
 Apertura: battente.
 Ante: vetro satinato arena con telaio laccato opaco arena, interno laccato opaco arena.
 Maniglie: Sydney a incasso, laccato opaco arena.
 Fianchi laterali: laccato opaco arena.
 Struttura: nobilitato rovere cenere.
 Schienali: nobilitato rovere cenere.
 Attrezzatura: nobilitato rovere cenere, tecnopelle 05 latte.
 Parti metalliche: ardesia opaco.

Ubik walk-in closet

h 102" - 392 d 23 3/4"
 Wall panels: 94 latte mat lacquered Skin melamine.
 Bases: cenere oak melamine.
 Equipment: cenere oak melamine, ardesia melamine, fumé glass 3050, fumé reflecting glass 5059, techno leather 05 latte.
 Metal parts: mat ardesia.

Senzafine Ocean

h 102" d 24"
 Opening: leaf doors.
 Doors: mat glass arena with arena mat lacquered profile, mat lacquered arena rear side.
 Handles: Sydney built-in, mat lacquer arena.
 Lateral sides: mat lacquer arena.
 Structure: cenere oak melamine.
 Backs: cenere oak melamine.
 Equipment: cenere oak melamine, techno leather 05 latte.
 Metal parts: mat ardesia.

Ubik

Design R&D Poliform

Cassettiera a vetrina - Showcase chest of drawers

Design Rodolfo Dordoni

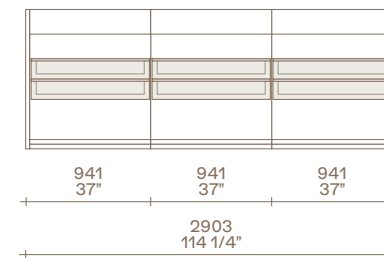
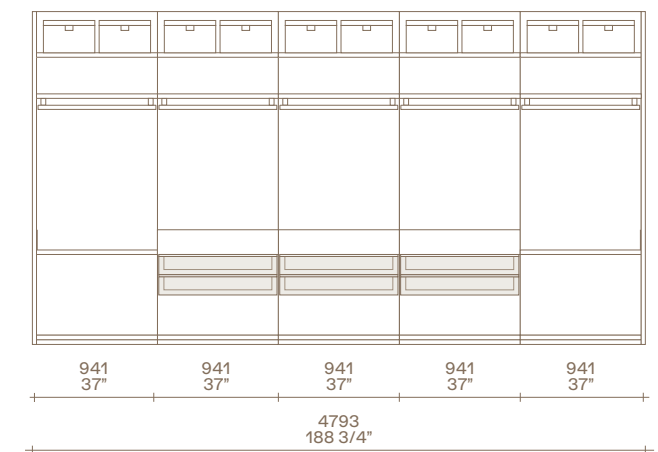
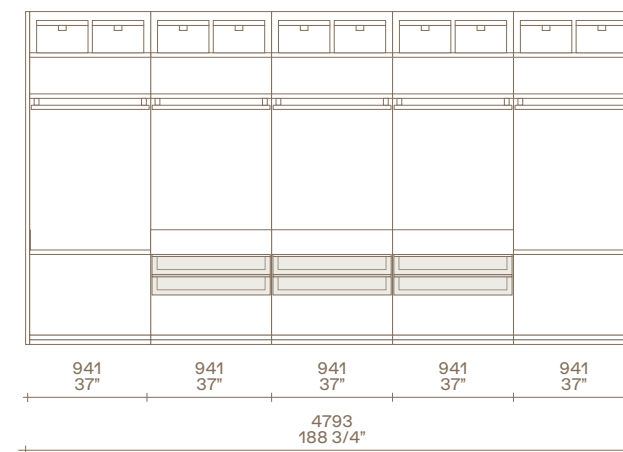

Senzafine Ocean

Design R&D Poliform

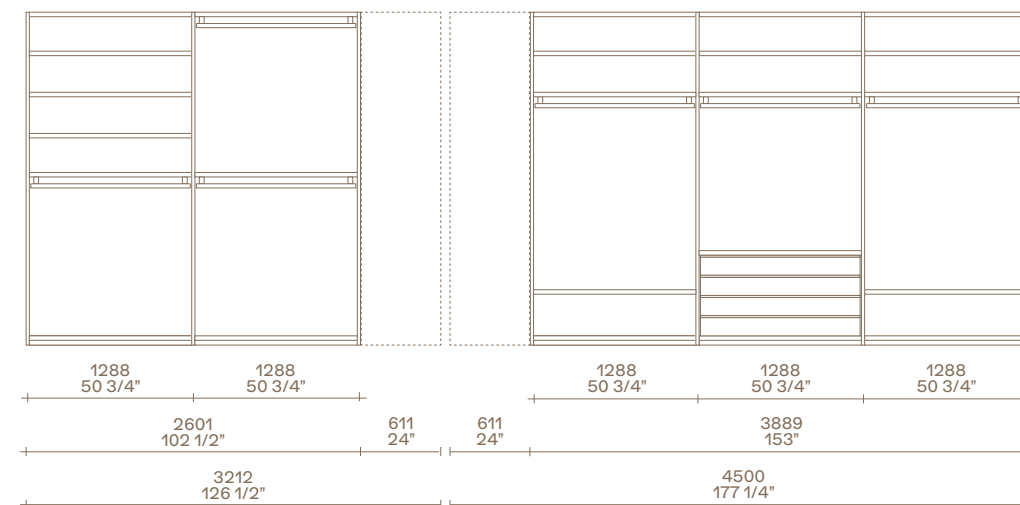

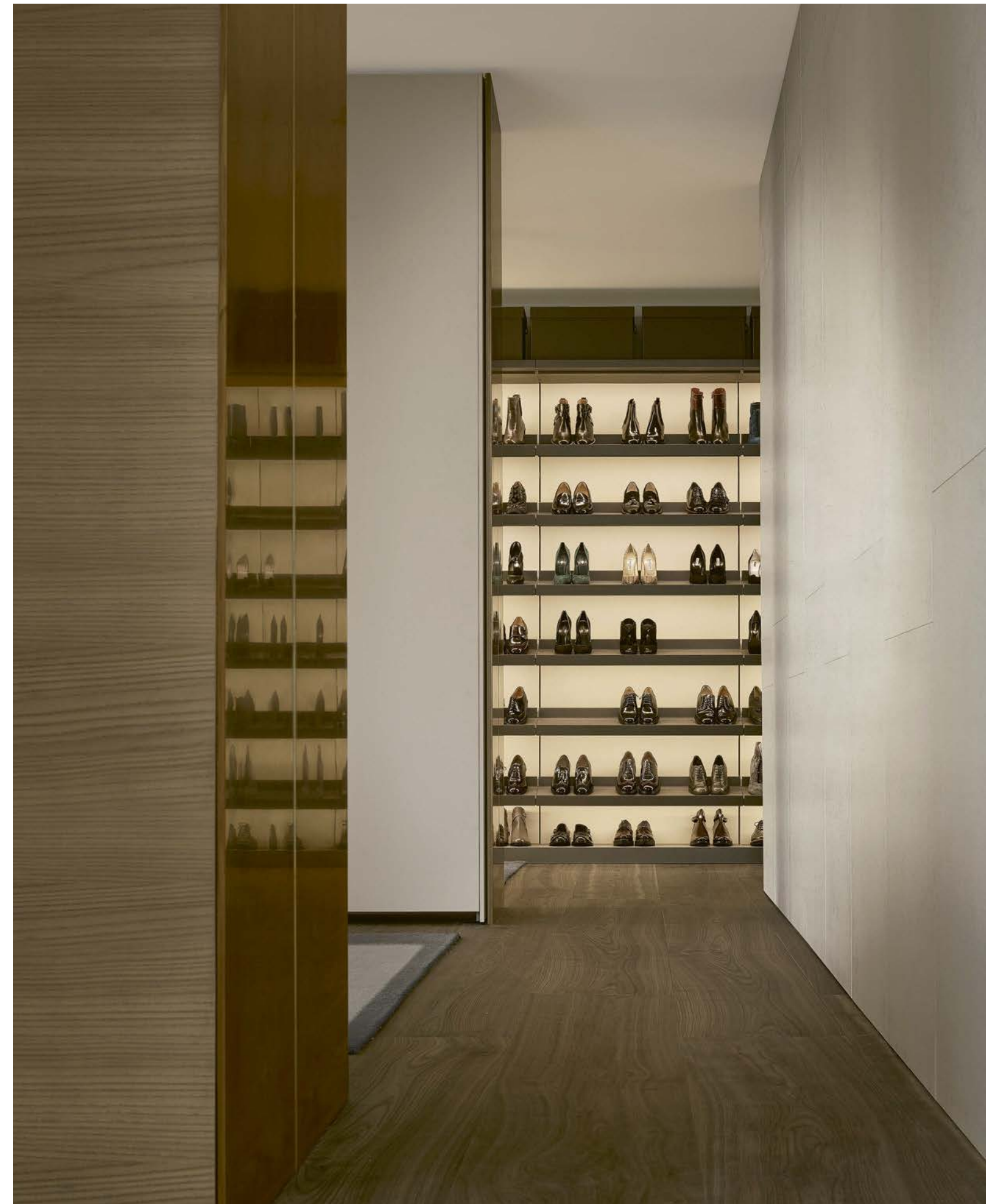





Nelle pagine precedenti: cabina armadio Ubik con pannelli a parete in nobilitato Skin laccato opaco 94 latte, basamenti in nobilitato rovere cenere, zoccolo in ardesia opaco. Ripiani in nobilitato rovere cenere e vetro fumé con telaio ardesia opaco. Cassettiere in nobilitato rovere cenere, frontali cassetti in vetro riflettente fumé con bordo e maniglia Track in ardesia opaco. In appoggio contenitori portacamicie in nobilitato rovere cenere, ripiani in tecnopelle 05 latte e cassetti rivestiti in tessuto ardesia. Armadi Senzafine Skin con ante scorrevoli complanari in nobilitato Skin laccato opaco 94 latte. A sinistra: dettaglio dell'interno con ripiano in tecnopelle 05 latte e telaio ardesia opaco. Sotto: dettaglio della maniglia Gap in ardesia opaco e tecnopelle 05 latte.

Previous pages: Ubik walk-in closet with wall mounted panels in 94 latte mat lacquered melamine Skin, bases in cenere oak melamine, plinth in mat ardesia. Shelves in cenere oak melamine and glass fumé with mat ardesia frame. Chests of drawers in cenere oak melamine, drawer fronts in fumé reflecting glass with edge and handle Track in mat ardesia. Shirt storages in cenere oak melamine are laid on the chests of drawers, shelves in techno leather 05 latte and drawers covered in fabric ardesia. Wardrobes Senzafine Skin with coplanar sliding doors in 94 latte mat lacquered melamine Skin. To the left: close up of the interior with shelf in techno leather 05 latte and mat ardesia frame. Below: close up of the Gap handle in mat ardesia and techno leather 05 latte.







Nella pagina precedente: cabina armadio Ubik con pannelli a parete in nobilitato Skin laccato opaco 94 latte, basamenti in nobilitato rovere cenere, zoccolo in ardesia opaco. Armadi Senzafine Skin con ante scorrevoli complanari in nobilitato Skin laccato opaco 94 latte. Poltrona Mad Chair in tessuto sfoderabile Zante 10 nero e gambe in olmo nero. Panca Home Hotel in olmo nero. A sinistra: dettaglio delle cassettiere in nobilitato rovere cenere e maniglia Track in ardesia opaco, top in tecnopelle 05 latte e telaio ardesia opaco. Ripiani in vetro fumè con telaio ardesia opaco. Sotto: dettaglio del ripiano portascarpe in nobilitato rovere cenere con bordi ardesia opaco.

Previous page: Ubik walk-in closet with wall mounted panels in 94 latte mat lacquered Skin melamine, bases in cenere oak melamine, plinth in mat ardesia. Wardrobes Senzafine Skin with coplanar sliding doors in 94 latte mat lacquered Skin melamine. Mad Chair armchair in removable fabric Zante 10 nero and black elm legs. Home Hotel bench in black elm. To the left: close up of the chests of drawers in cenere oak melamine and Track handle in mat ardesia, top in techno leather 05 latte and frame in mat ardesia. Shelves in fumé glass with mat ardesia frame. Below: close up of the shoe shelf in cenere oak melamine with edges in mat ardesia.



In questa pagina: cabina armadio Ubik con pannelli a parete in nobilitato Skin laccato opaco 94 latte, basamenti in nobilitato rovere cenere, zoccolo in ardesia opaco. Ripiani in nobilitato rovere cenere e vetro fumé con telaio ardesia opaco, luce led integrata. Cassettiere in nobilitato rovere cenere e maniglia Track in ardesia opaco, piano superiore in tecnopelle 05 latte e telaio ardesia opaco. Ripiani portascarpe in nobilitato rovere cenere con bordi ardesia opaco. Armadio Senzafine Skin con ante scorrevoli complanari in nobilitato Skin laccato opaco 94 latte. Panca Home Hotel in olmo nero.

This page: Ubik walk-in closet with wall mounted panels in 94 latte mat lacquered Skin melamine, bases in cenere oak melamine, plinth in mat ardesia. Shelves in cenere oak melamine and fumé glass with mat ardesia frame, integrated led light. Chests of drawers in cenere oak melamine and Track handle in mat ardesia, upper shelf in techno leather 05 latte and mat ardesia frame. Shoe shelves in cenere oak melamine with mat ardesia edges. Wardrobe Senzafine Skin with coplanar sliding doors in 94 latte mat lacquered Skin melamine. Home hotel bench in black elm.



INTERIOR 17

Ubik cabina armadio

h 2590 p 605
 Pannelli a parete: nobilitato Skin laccato opaco 94 latte.
 Basamenti: nobilitato rovere cenere.
 Attrezzatura: nobilitato rovere cenere, vetro fumé 3050, vetro riflettente fumé 5059, tecnopelle 05 latte.
 Parti metalliche: ardesia opaco.

Senzafine Skin

h 2590 p 609
 Apertura: scorrevole complanare.
 Ante: nobilitato Skin laccato opaco 94 latte con profilo laccato opaco latte.
 Maniglie: Gap ardesia opaco, fondo tecnopelle 05 latte.
 Fianchi laterali: laccato opaco 94 latte.
 Struttura: nobilitato rovere cenere.
 Schienali: nobilitato rovere cenere.
 Attrezzatura: nobilitato rovere cenere, tecnopelle 05 latte.
 Parti metalliche: ardesia opaco.

Ubik walk-in closet

h 102" d 23 3/4"
 Wall panels: 94 latte mat lacquered Skin melamine.
 Bases: cenere oak melamine.
 Equipment: cenere oak melamine, fumé glass 3050, fumé reflecting glass 5059, techno leather 05 latte.
 Metal parts: mat ardesia.

Senzafine Skin

h 102" d 24"
 Opening: coplanar sliding doors.
 Doors: 94 latte mat lacquered Skin melamine with latte mat lacquered profile.
 Handles: Gap mat ardesia, bottom techno leather 05 latte.
 Lateral sides: mat lacquer 94 latte.
 Structure: cenere oak melamine.
 Backs: cenere oak melamine.
 Equipment: cenere oak melamine, techno leather 05 latte.
 Metal parts: mat ardesia.

Ubik Design R&D Poliform

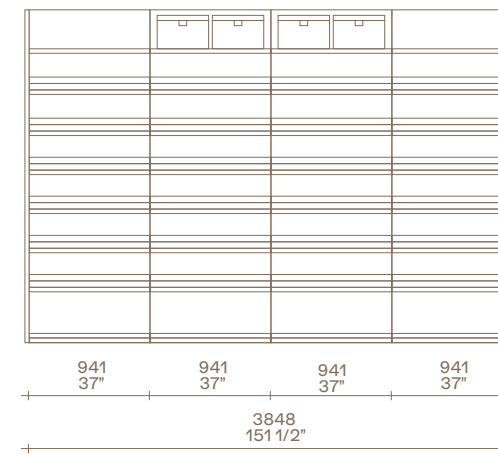
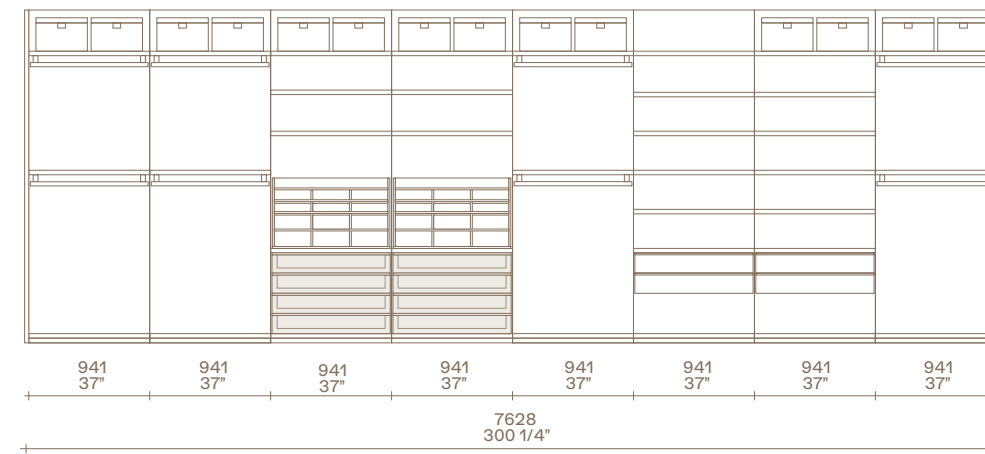

Senzafine Skin Design R&D Poliform

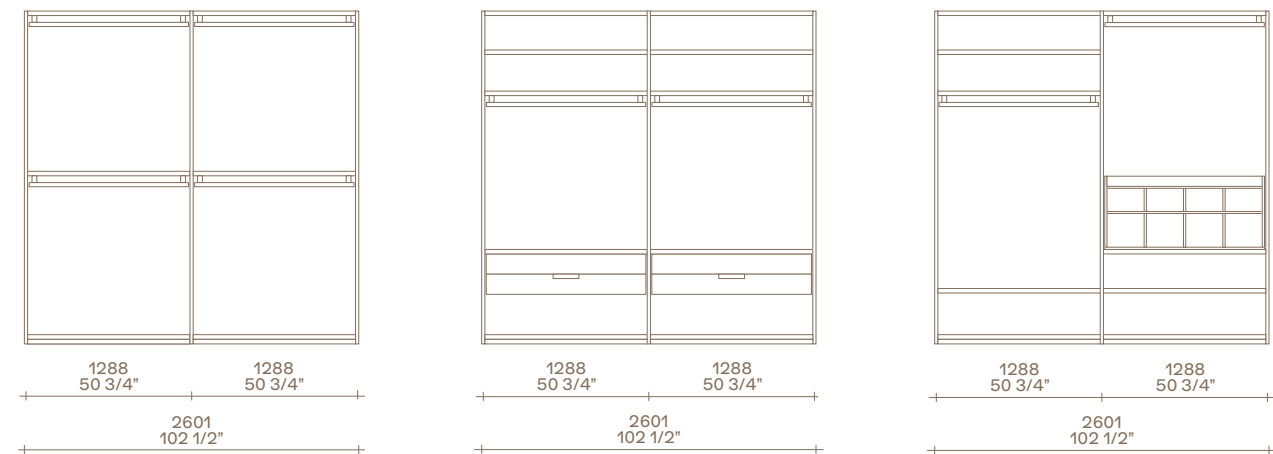

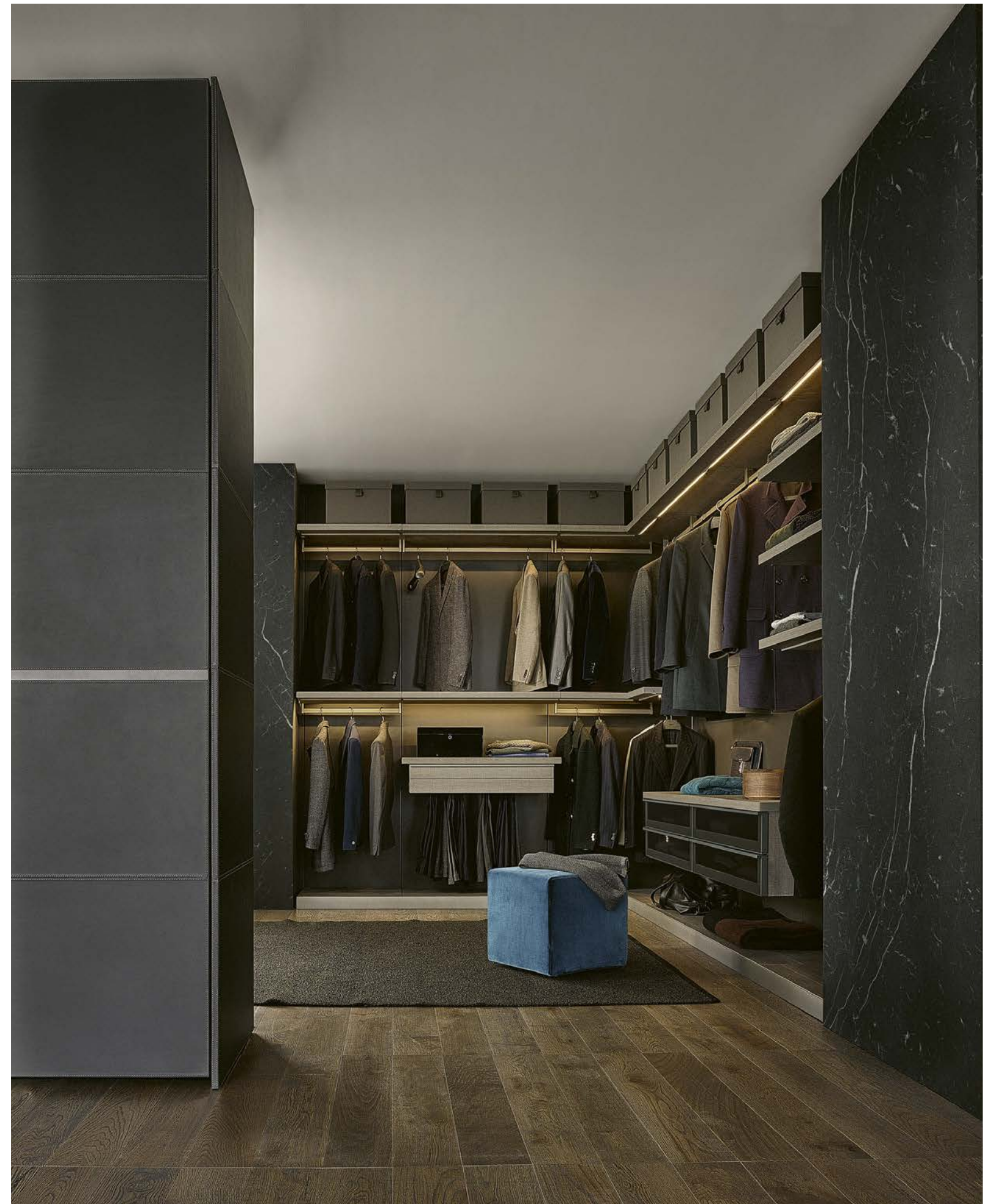





Nelle pagine precedenti: cabina armadio Ubik con pannelli a parete in vetro acidato bronzo, basamenti in nobilitato rovere cenere, zoccolo in ardesia opaco. Ripiani in nobilitato rovere cenere e luce led integrata. Pouf Play in velluto sfoderabile Persia 58 danubio. In questa pagina: dettagli delle cassettiere in nobilitato rovere cenere, frontali cassetti in vetro riflettente fumé con bordo e maniglia Track in ardesia opaco, piano superiore in nobilitato rovere cenere.

Previous pages: Ubik walk-in closet with etched glass bronzo wall panels, bases in cenere oak melamine, plinth in mat ardesia. Shelves in cenere oak melamine and integrated led light. Play pouf in removable velvet Persia 58 danubio. This page: close up of the chests of drawers in cenere oak melamine, drawer fronts in fumé reflecting glass with edge and handle Track in mat ardesia, upper shelf in cenere oak melamine.



In questa pagina: dettaglio del vassoio in nobilitato rovere cenere attrezzato con vaschette porta orologi, porta gemelli e porta orecchini rivestite in pelle grigia, maniglia Track in ardesia opaco. Porta pantaloni in nobilitato rovere cenere. Ripiani in nobilitato rovere cenere e luce led integrata.

This page: close up of the tray in cenere oak melamine accessorized with open cases, watchcase, cufflink holder and earring case covered in grey leather, Track handle in mat ardesia. Trousers hanger in cenere oak melamine. Shelves in cenere oak melamine and integrated led light.



INTERIOR 18

Ubik cabina armadio

h 2590 p 605

Pannelli a parete: vetro acidato
bronzo 5323.

Basamenti: nobilitato rovere cenere.

Attrezzatura: nobilitato rovere
cenere, vetro riflettente fumé 5059.

Parti metalliche: ardesia opaco.

Ubik walk-in closet

h 102" d 23 3/4"

Wall panels: etched glass bronzo
5323.

Bases: cenere oak melamine.

Equipment: cenere oak melamine,
fumé reflecting glass 5059.

Metal parts: mat ardesia.

Ubik

Design R&D Poliform

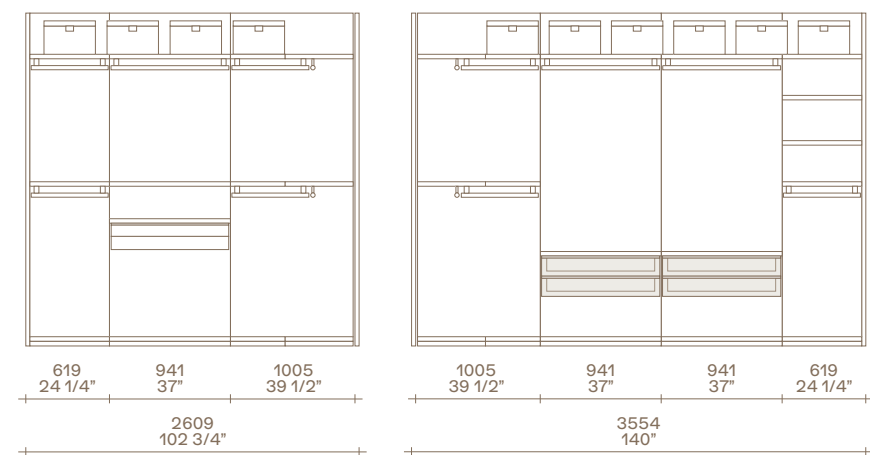

ISLAND CHESTS OF DRAWERS

Le cabine armadio si arricchiscono delle cassettiere a isola, elementi che completano con eleganza l'ambiente dedicato al guardaroba. Perfette a centrostanza, contengono ed espongono allo stesso tempo, grazie ai frontali in legno o vetro. La peculiarità di Senzafine è la versatilità: la cassetiera firmata Poliform si può personalizzare nelle dimensioni e nelle attrezzature, abbinando le finiture a quelle della cabina armadio. Set-Up, disegnata da Rodolfo Dordoni, è un gioiello di raffinatezza, con top in vetro e vani a giorno.

The walk-in closets are enriched by island chests of drawers, elements that elegantly complete the wardrobe environment. Perfect in the middle of the room, they store and display at the same time, thanks to the fronts in wood or glass. The peculiarity of Senzafine is its versatility: the chest of drawers by Poliform can be customized in size and equipment, matching the finishes with those of the walk-in closet. Set-Up, designed by Rodolfo Dordoni, is a jewel of refinement, with a glass top and open compartments.







Qui e nelle pagine precedenti: cassetiera a isola Senzafine in nobilitato rovere cenere con piano superiore in tecnopelle 02 moro e telaio ardesia opaco. Da un lato cassetti in nobilitato rovere cenere, dall'altro cassetti in vetro riflettente fumé con bordo ardesia opaco e in nobilitato rovere cenere, maniglie Track ardesia opaco. Poltrone Mad Chair in velluto sfoderabile Persia 54 prussia e gambe in rovere spessart. Armadio Senzafine New Entry con ante battenti in laccato opaco bianco, parte centrale con ante Fitted in vetro trasparente riflettente e telaio ardesia opaco. Sotto: dettaglio del cassetto attrezzato con griglia divisoria in nobilitato ardesia, fondo rivestito in tecnopelle 02 moro.

This and previous pages: Senzafine island chest of drawers in cenere oak melamine with upper shelf in techno leather 02 moro and mat ardesia frame. On one side drawers in cenere oak melamine, on the other side in fume reflecting glass with mat ardesia edge and in cenere oak melamine, Track handle mat ardesia. Mad Chair armchairs in removable velvet Persia 54 prussia and spessart oak legs. Wardrobe Senzafine New Entry with bianco mat lacquered leaf doors, central units with Fitted doors in transparent reflecting glass and mat ardesia frame. Below: close up of the drawer accessorized with partition in melamine ardesia, bottom covered in techno leather 02 moro.



SENZAFINE

Cassettiera a isola

Struttura: nobilitato rovere cenere.
Piano superiore: tecnopelle 02 moro,
telaio ardesia opaco.

Frontali cassetti: nobilitato rovere cenere,
vetro riflettente fumé 5059.

Maniglie: Track ardesia opaco.

Fondo cassetti: tecnopelle 02 moro.

Parti metalliche: ardesia opaco.

Island chest of drawers

Structure: cenere oak melamine.

Upper shelf: techno leather 02 moro, mat
ardesia frame.

Drawer fronts: cenere oak melamine,
reflecting glass fumé 5059.

Handles: Track mat ardesia.

Drawers bottom: techno leather 02 moro.

Metal parts: mat ardesia.

Senzafine Design R&D Poliform

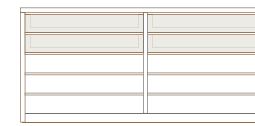

1831
72"



1131
44 1/2"

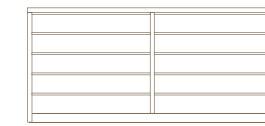

870
34 1/4"

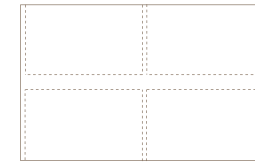





Qui e nelle pagine precedenti: cassetiera a isola Set-up in laccato opaco ardesia con piano superiore in vetro fumé e tecnopelle 05 latte. Su entrambi i lati lunghi, vano a giorno con ripiani in vetro fumé, un cassetto superiore e due cassetti inferiori con piano rivestito in tecnopelle 05 latte. Sul lato corto, cassetiera a vetrina con piano superiore in vetro fumé, cassetto con frontale in laccato opaco ardesia e piano in tecnopelle 05 latte, sul retro del cassetto, un soffietto chiude lo spazio dell'estrazione. Cassetti inferiori in vetro riflettente fumé, bordo e maniglia Track in ardesia opaco. Cabina armadio Senzafine con struttura in nobilitato ardesia e schienali in metacrilato roller latte, fianchi a telaio in ardesia opaco. Pouf Henry in olmo nero e seduta in pelle non sfoderabile Nabuk 09 ruggine. Tappeto Tratto ruggine.

This and previous pages: Set-up island chest of drawers in ardesia mat lacquer with upper shelf in fumé glass and techno leather 05 latte. On both long sides, open compartment with shelves in fumé glass, one upper drawer and two lower drawers with shelf covered in techno leather 05 latte. On the short side, showcase chest of drawers with upper shelf in fumé glass, drawer with front in ardesia mat lacquer and shelf in techno leather 05 latte, at the back of the drawer, a pleated fabric covers the extraction space. Lower drawers in fumé reflecting glass, edge and handle Track in mat ardesia. Walk-in closet Senzafine with structure in melamine ardesia and back in methacrylate roller latte, frame sides in mat ardesia. Henry pouf in black elm with seat cushion in non-removable leather Nabuk 09 ruggine. Carpet Tratto ruggine.



SET-UP

Cassettiera a isola

Struttura: laccato opaco ardesia.
Piano superiore: vetro fumé 3050, tecnopelle 05 latte.
Frontali cassetti: laccato opaco ardesia, vetro riflettente fumé 5059.
Maniglie: Track ardesia opaco.
Fondo cassetti: tecnopelle 05 latte.
Vano a giorno: piano inferiore tecnopelle 05 latte, ripiano vetro fumé 3050.
Parti metalliche: ardesia opaco.

Island chest of drawers

Structure: mat lacquer ardesia.
Upper shelf: fumé glass 3050, techno leather 05 latte.
Drawer fronts: mat lacquer ardesia, reflecting glass fumé 5059.
Handles: Track mat ardesia.
Drawers bottom: techno leather 05 latte.
Open compartment: lower shelf techno leather 05 latte, shelf fumé glass 3050.
Metal parts: mat ardesia.

Set-Up Design Rodolfo Dordoni

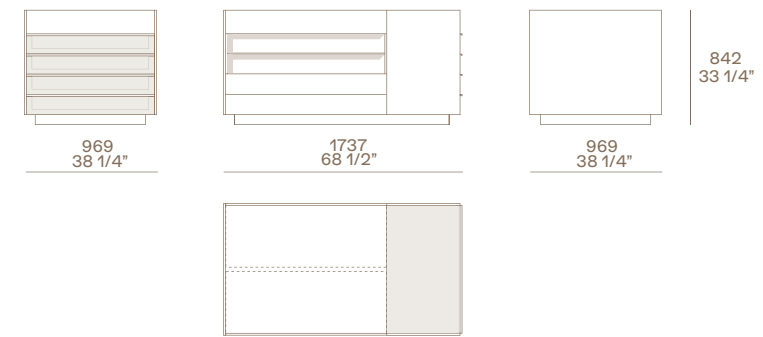

TECHNICAL DATA

SENZAFINE ARMADI E CABINA ARMADIO SENZAFINE WARDROBES AND WALK-IN CLOSET	276
UBIK CABINA ARMADIO UBIK WALK-IN CLOSET	304
CASSETTIERE A ISOLA ISLAND CHESTS OF DRAWERS	310

SENZAFINE ARMADI E CABINA ARMADIO SENZAFINE WARDROBES AND WALK-IN CLOSET

Un sistema armadi e cabina armadio progettato con una modularità evoluta, in grado di inserirsi in ogni spazio.

La cabina armadio è caratterizzata dai fianchi di spessore mm 35, che ne sottolineano la solidità formale e il rigore geometrico. Il fianco telaio e il fianco telaio vetro (spessore mm 25), permettono di creare armadi e cabine armadio di grande leggerezza formale e di definire composizioni armadio caratterizzate dagli interni "aperti".

Il sistema propone un'organizzazione evoluta degli interni. Sono disponibili fasce di tamponamento orizzontali o verticali, elementi terminali e per composizioni ad angolo, con cambi di profondità, a ponte o con passaggi porta. Sono previsti tagli a misura in larghezza, altezza e profondità.

A wardrobes and a walk-in closet system with a contemporary modularity, suitable to any space.

The walk-in closet is distinguished by vertical panels of 1 1/2" that bring out the solidity of shapes and the geometry. The frame side and the glass frame side (thickness 1") allow to create great formal lightness walk-in closets and to realize wardrobes characterized by inner open units.

Senzafine system proposes an advanced organization of the internal parts of the cabinets. Horizontal or vertical filler pieces are available, end and corner units, changes in depth, bridge units and door passages. Customizations in width, height and depth are available.

Cabina armadio fianco spessore mm 35

Per ottenere la larghezza totale, aggiungere alla somma delle colonne mm 35 relativi al fianco laterale.

Walk-in closet side thickness 1 1/2"

To obtain the total width, add to the sum of the columns 1 1/2" for the lateral side.

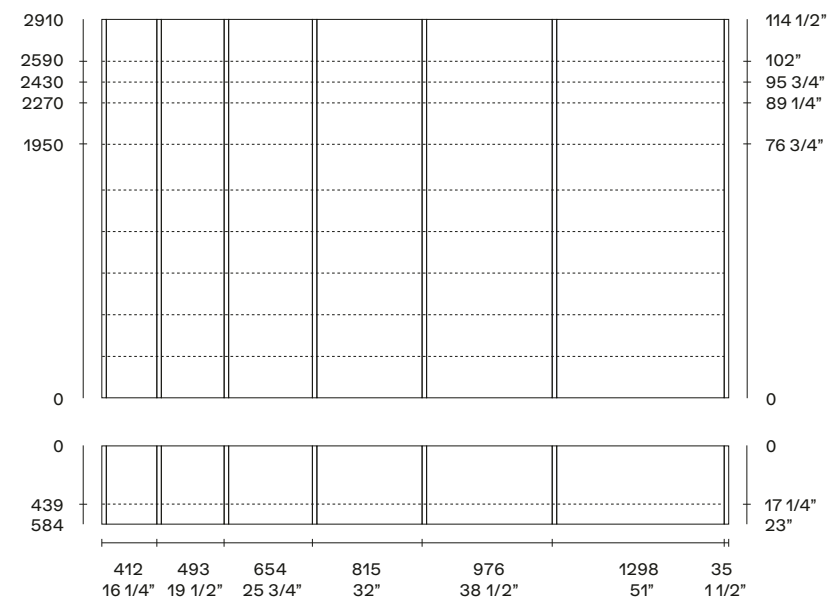

Tipologie di apertura degli armadi Wardrobes opening typologies

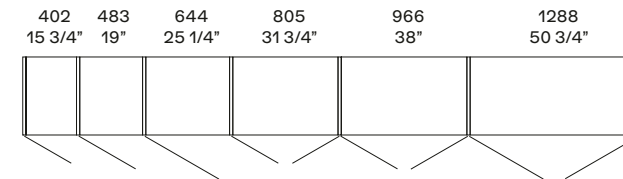

Battente
Leaf door

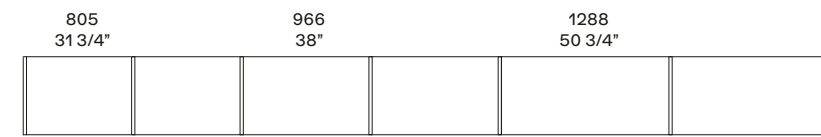

Scorrevole
Sliding door

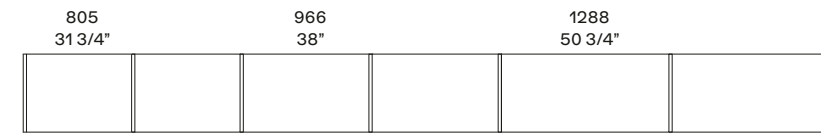

Complanare
Coplanar door

Armadi e cabina armadio fianco spessore mm 25

Per ottenere la larghezza totale, aggiungere alla somma delle colonne mm 25 relativi al fianco laterale.

Wardrobes and walk-in closet side thickness 1"

To obtain the total width, add to the sum of the columns 1" for the lateral side.

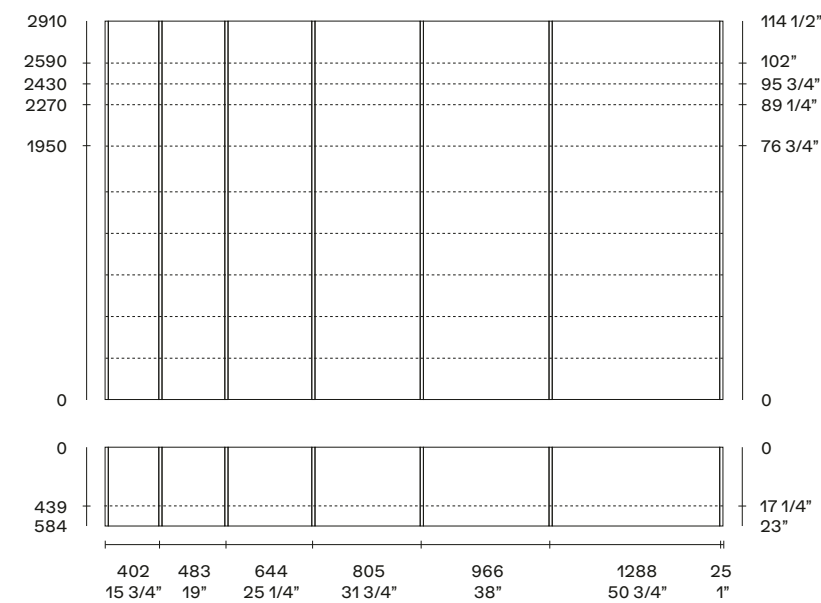

SENZAFINE ORGANIZZAZIONE DEGLI INTERNI
SENZAFINE INNER ORGANISATION

Attrezzature armadi h 2590

- | | | |
|--|---|---|
| <p>1 1 ripiano
1 tubo appendiabiti
Vassoio portaoggetti
Cassettiera sospesa 2 cassetti vetro, maniglia Track</p> <p>2 1 tubo appendiabiti
1 svuotatasche
Portapantaloni con vassoio portaoggetti, maniglia Track</p> <p>3 1 tubo appendiabiti
Contentore portacamicie con cassetti alti e bassi rivestiti in tessuto
Cassettiera a terra 4 cassetti legno, maniglia Step</p> <p>4 4 ripiani
4 scatole larghezza mm 400
3 ripiani portascarpe inclinati</p> | <p>5 1 ripiano
1 tubo appendiabiti
Cassettiera a vetrina
Cassettiera a terra 4 cassetti legno, maniglia Track</p> <p>6 1 ripiano
3 scatole larghezza mm 260
1 tubo appendiabiti
Cassettiera a vetrina
Cassettiera sospesa 2 cassetti vetro, maniglia Track</p> <p>7 1 servetto
Camiciere con 2 vassoi
1 ripiano
1 tubo appendiabiti</p> | <p>8 1 ripiano
1 tubo appendiabiti
Cassettiera a terra 1 cassetto alto legno, maniglia Track e 2 vassoi</p> <p>9 4 ripiani
4 scatole larghezza mm 400
3 vassoi portascarpe estraibili per cabina armadio</p> <p>10 1 tubo appendiabiti
Contentore portaborse
Cassettiera a terra 4 cassetti vetro, maniglia Track</p> <p>11 1 ripiano
2 tubi appendiabiti</p> <p>12 3 ripiani
1 tubo appendiabiti
Contentore porta scarpe con cassetti rivestiti in tessuto</p> |
|--|---|---|

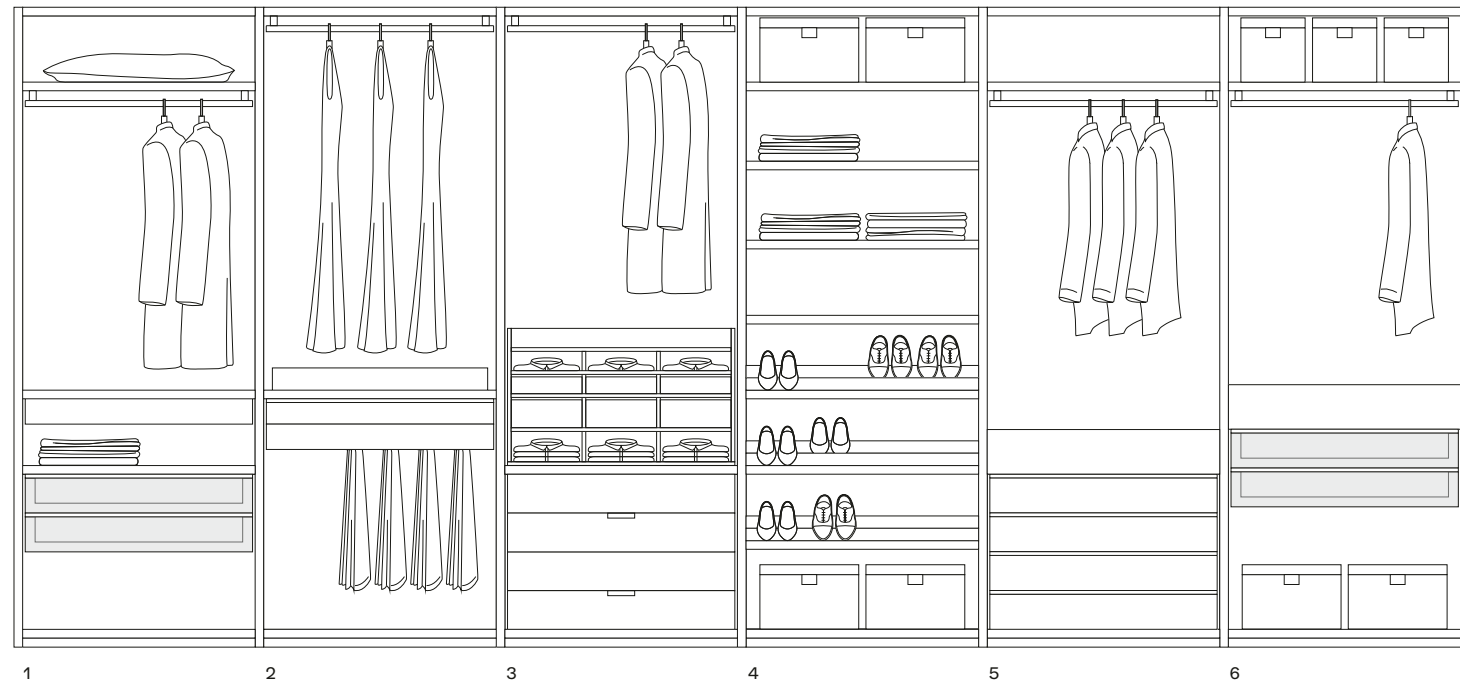

Wardrobes equipment h 102"

- | | | |
|---|--|---|
| <p>1 1 shelf
1 hanging rail
Storage tray
Hanging chest of drawers with 2 glass drawers, Track handle</p> <p>2 1 hanging rail
1 jewellery tray
Trousers hanger with storage tray, Track handle</p> <p>3 1 hanging rail
Shirts storage with high and low drawers covered in fabric
Freestanding chest of drawers with 4 wooden drawers, Step handle</p> <p>4 4 shelves
4 boxes width 15 3/4"
3 inclined shoes shelves</p> | <p>5 1 shelf
1 hanging rail
Showcase chest of drawers
Freestanding chest of drawers with 4 wooden drawers, Track handle</p> <p>6 1 shelf
3 boxes width 10 1/4"
1 hanging rail
Showcase chest of drawers
Hanging chest of drawers with 2 glass drawers, Track handle</p> <p>7 1 pull down hanging bar
Pull out shirts storage with 2 trays
1 shelf
1 hanging rail</p> | <p>8 1 shelf
1 hanging rail
Freestanding chest of drawers with 1 high wooden drawer, Track handle and 2 trays</p> <p>9 4 shelves
4 boxes width 15 3/4"
3 pull out shoes trays for walk-in closet</p> <p>10 1 hanging rail
Handbags storage
Freestanding chest of drawers with 4 glass drawers, Track handle</p> <p>11 1 shelf
2 hanging rails</p> <p>12 3 shelves
1 hanging rail
Shoes storage with drawers covered in fabric</p> |
|---|--|---|

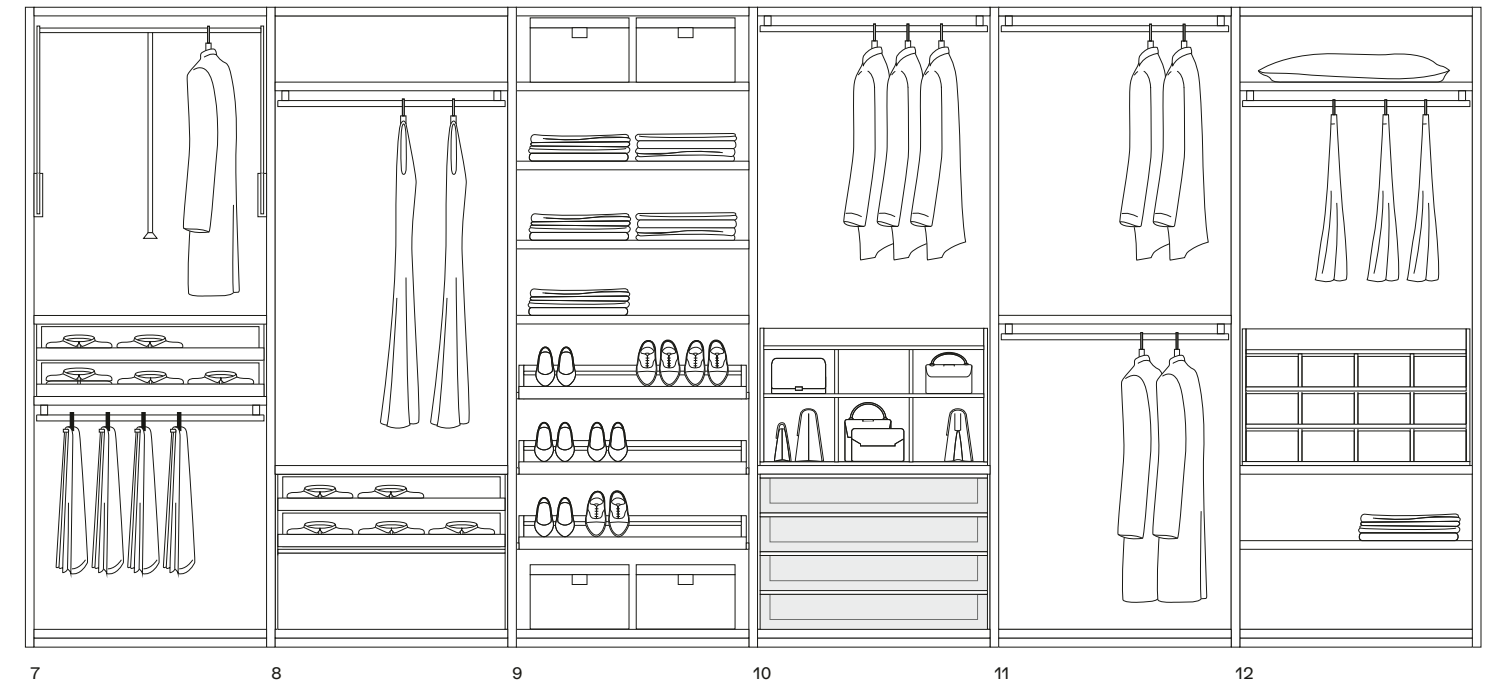

SENZAFINE CLUB
Design R&D Poliform

Aperture

- B Battente
- S Scorrevole
- C Complanare
- CS Cassetti esterni

Finiture anta

Nobilitato club bianco 01

Openings

- B Leaf door
- S Sliding door
- C Coplanar door
- CS External drawers

Door finishings

Club melamine bianco 01

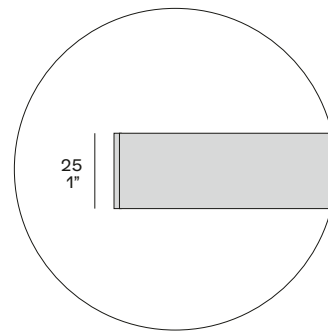

SENZAFINE GRAFFITI
Design R&D Poliform

Aperture

- B Battente
- S Scorrevole
- C Complanare
- CS Cassetti esterni

Finiture anta

Nobilitato graffiti bianco 01
Nobilitato graffiti canapa 35
Nobilitato graffiti ghiaccio 60
(texture orizzontale)

Openings

- B Leaf door
- S Sliding door
- C Coplanar door
- CS External drawers

Door finishings

Graffiti melamine bianco 01
Graffiti melamine canapa 35
Graffiti melamine ghiaccio 60
(horizontal texture)

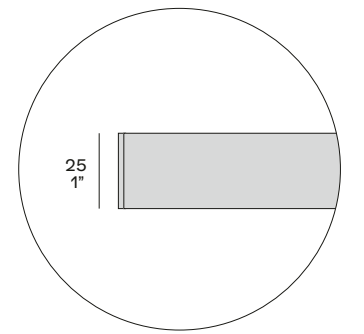

SENZAFINE SAND

Design R&D Poliform

Aperture

- B Battente
- S Scorrevole
- C Complanare
- CS Cassetti esterni

Finiture anta

- Nobilitato olmo
- Nobilitato noce c.
- Nobilitato rovere cenere
- Nobilitato rovere spessart (texture verticale)

Openings

- B Leaf door
- S Sliding door
- C Coplanar door
- CS External drawers

Door finishings

- Elm melamine
- Walnut c. melamine
- Cenere oak melamine
- Spessart oak melamine (vertical texture)

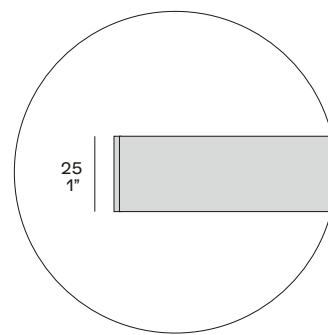

SENZAFINE CANVAS

Design R&D Poliform

Aperture

- B Battente
- S Scorrevole
- C Complanare
- CS Cassetti esterni

Finiture anta

- Nobilitato canvas beige
- Nobilitato canvas grigio (texture verticale)

Bordo perimetrale

- abs applicato laser
- colore ardesia
- colore champagne

Openings

- B Leaf door
- S Sliding door
- C Coplanar door
- CS External drawers

Door finishings

- Canvas beige melamine
- Canvas grigio melamine (vertical texture)

Perimeter edge

- abs laser-applied
- colour ardesia
- colour champagne

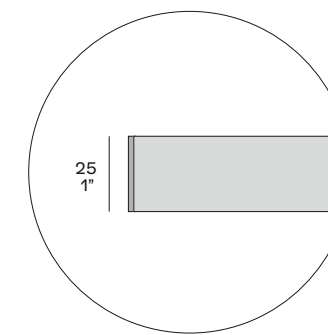

SENZAFINE SILK

Design R&D Poliform

Aperture

- B Battente
- S Scorrevole
- C Complanare
- CS Cassetti esterni

Finiture anta

- Nobilitato silk canapa
- Nobilitato silk grey
- Nobilitato silk bronzo (texture verticale)

Openings

- B Leaf door
- S Sliding door
- C Coplanar door
- CS External drawers

Door finishings

- Silk canapa melamine
- Silk grey melamine
- Silk bronzo melamine (vertical texture)

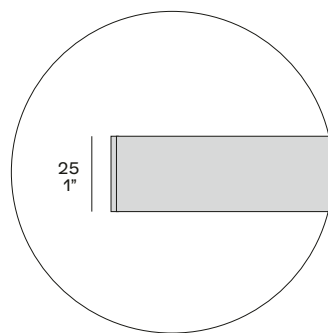

SENZAFINE SKIN

Design R&D Poliform

Aperture

- B Battente
- S Scorrevole
- C Complanare

Finiture anta

- Nobilitato skin laccato opaco colori
- Nobilitato skin laccato opaco nei colori: 94 latte, 97 elefante, 93 moro, 98 nocciola

Finiture profilo

- Ardesia opaco
- Champagne opaco
- Laccato opaco colori
- Laccato opaco nei colori: 94 latte, 97 elefante, 93 moro, 98 nocciola

Openings

- B Leaf door
- S Sliding door
- C Coplanar door

Door finishings

- Skin melamine mat lacquered colours
- Skin melamine mat lacquered in colours: 94 latte, 97 elefante, 93 moro, 98 nocciola

Profile finishings

- Mat ardesia
- Mat champagne
- Mat lacquered colours
- Mat lacquered in the colours: 94 latte, 97 elefante, 93 moro, 98 nocciola

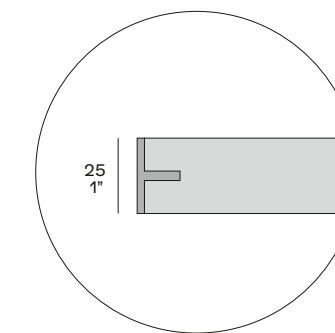

SENZAFINE NEW ENTRY

Design R&D Poliform

Aperture

- B Battente
- S Scorrevole
- C Coplanare
- CS Cassetti esterni

Finiture anta

- Laccato opaco colori
- Laccato semilucido colori
- Laccato lucido colori
- Laccato metallico colori (texture verticale)
- Noce gold (venatura orizzontale)
- Rovere spessart (venatura orizzontale)
- Olmo nero (venatura orizzontale)

Openings

- B Leaf door
- S Sliding door
- C Coplanar door
- CS External drawers

Door finishings

- Mat lacquered colours
- Semi-glossy lacquered colours
- Glossy lacquered colours
- Metallic lacquered colours (vertical texture)
- Gold walnut (horizontal grain)
- Spessart oak (horizontal grain)
- Black elm (horizontal grain)

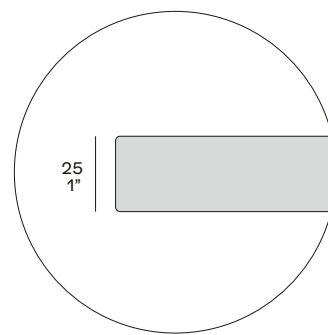

SENZAFINE PLUS

Design R&D Poliform

Aperture

- B Battente
- C Coplanare

Finiture anta

- Laccato opaco colori
- Laccato semilucido colori
- Laccato metallico colori (texture verticale)
- Noce gold (venatura verticale)
- Rovere spessart (venatura verticale)
- Olmo nero (venatura verticale)

Finiture maniglia Plus integrata

- Ardesia opaco
- Champagne opaco
- Brown nickel satinato
- Laccato opaco colori

Openings

- B Leaf door
- C Coplanar door

Door finishings

- Mat lacquered colours
- Semi-glossy lacquered colours
- Metallic lacquered colours (vertical texture)
- Gold walnut (vertical grain)
- Spessart oak (vertical grain)
- Black elm (vertical grain)

Integrated Plus handle finishings

- Mat ardesia
- Mat champagne
- Brushed brown nickel
- Mat lacquered colours

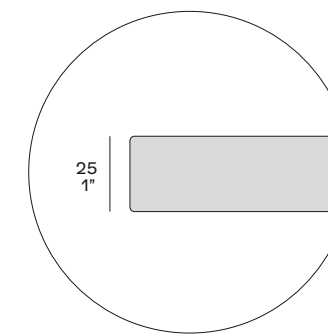

SENZAFINE MADISON

Design Carlo Colombo

Aperture

B Battente

Finiture anta

Rovere spessart (venatura orizzontale)

Openings

B Leaf door

Door finishings

Spessart oak (horizontal grain)

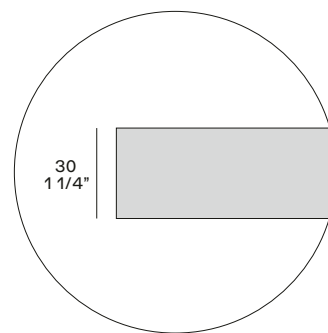

SENZAFINE STRATUS

Design Giuseppe Bavuso

Aperture

B Battente
S Scorrevole
C Coplanare

Finiture anta

Rovere spessart (venatura verticale)
Noce gold (venatura verticale)

Maniglia - finiture

Rail ardesia opaco
Rail champagne opaco
Rail laccato opaco colori

Openings

B Leaf door
S Sliding door
C Coplanar door

Door finishings

Spessart oak (vertical grain)
Gold walnut (vertical grain)

Handle - finishings

Rail mat ardesia
Rail mat champagne
Rail mat lacquered colours

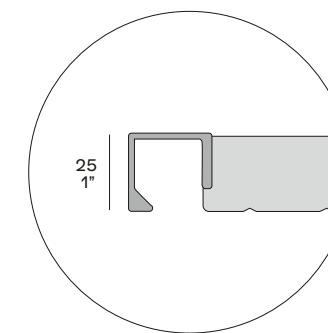

SENZAFINE EGO
Design Giuseppe Bavuso

Aperture
B Battente

Finiture anta
Vetro trasparente 1000
Vetro trasparente riflettente 5000
Vetro fumé 3050
Vetro riflettente bronzato 5051
Vetro line 2700

Finiture telaio e maniglia Ego
Ardesia opaco
Champagne opaco
Laccato opaco colori

Openings
B Leaf door

Door finishings
Transparent glass 1000
Transparent reflecting glass 5000
Fumé glass 3050
Bronzed reflecting glass 5051
Line glass 2700

Frame and Ego handle finishings
Mat ardesia
Mat champagne
Mat lacquered colours

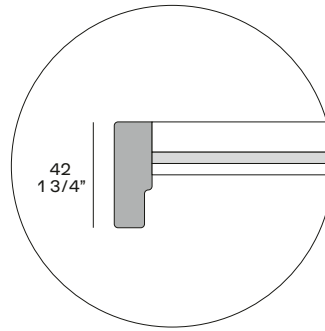

SENZAFINE FITTED
Design Rodolfo Dordoni

Aperture
B Battente

Finiture anta
Vetro trasparente extrachiaro 2000
Vetro trasparente riflettente 5000
Vetro fumé 3050
Vetro riflettente bronzato 5051

Finiture telaio e maniglia Fitted
Ardesia opaco
Champagne opaco
Laccato opaco colori

Per telaio ardesia opaco e laccato opaco colori serigrafia vetro color ferro.
Per telaio champagne opaco serigrafia vetro color champagne.

Openings
B Leaf door

Door finishings
Transparent extralight glass 2000
Transparent reflecting glass 5000
Fumé glass 3050
Bronzed reflecting glass 5051

Frame and Fitted handle finishings
Mat ardesia
Mat champagne
Mat lacquered colours

For mat ardesia mat lacquered colours frame glass screen-printing colour ferro.
For mat champagne frame glass screen-printing colour champagne.

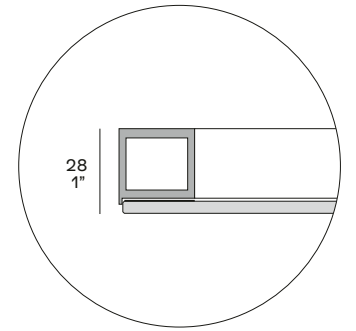

SENZAFINE OCEAN

Design R&D Poliform

Aperture

- B Battente
- S Scorrevole
- C Coplanare

Finiture anta

Vetro lucido 6 colori
Vetro satinato 6 colori
Vetro acidato 3 colori
Vetro riflettente blu 5010
Specchio bianco 4000
(anta battente con interno laccato stesso colore del telaio, anta coplanare con interno in nobilitato bianco)

Finiture telaio

Ardesia opaco
Champagne opaco
Laccato opaco colori

Openings

- B Leaf door
- S Sliding door
- C Coplanar door

Door finishings

Glossy glass 6 colours
Mat glass 6 colours
Etched glass 3 colours
Blu reflecting glass 5010
White mirror 4000
(leaf door with inner side in the same colour of the frame, coplanar door with inner side in white melamine)

Frame finishings

Mat ardesia
Mat champagne
Mat lacquered colours

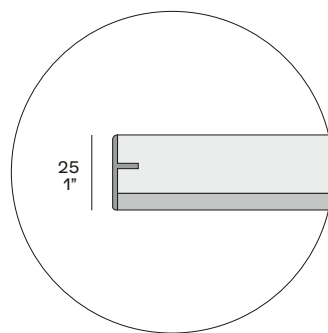

SENZAFINE COVER TECNOPELLE

Design R&D Poliform

Aperture

- B Battente
- C Coplanare

Finiture anta

Tecnopelle 4 colori

Finiture telaio e profili

Ardesia opaco
Champagne opaco

Maniglia - finiture

Cover - ardesia opaco e rivestita in tecnopelle 4 colori
Cover - champagne opaco e rivestita in tecnopelle 4 colori
Fitted - ardesia opaco
Fitted - champagne opaco

Openings

- B Leaf door
- C Coplanar door

Door finishings

Tecno leather 4 colours

Frame and profiles finishings

Mat ardesia
Mat champagne

Handle - finishings

Cover - mat ardesia and covered in techno leather 4 colours
Cover - mat champagne and covered in techno leather 4 colours
Fitted - mat ardesia
Fitted - mat champagne

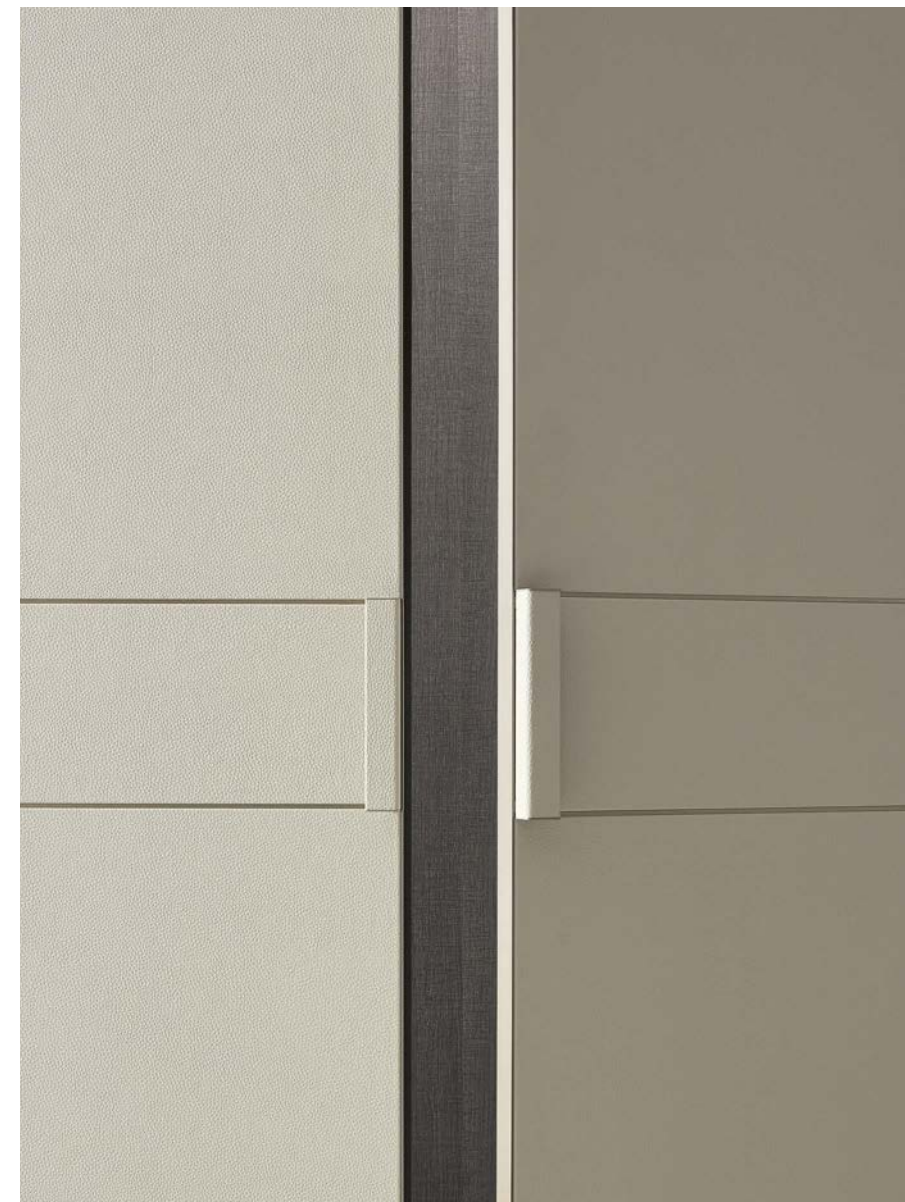
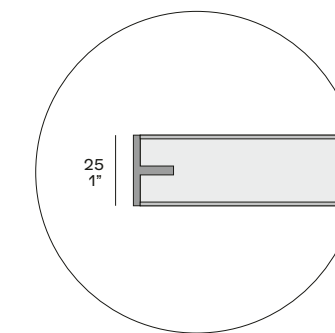

SENZAFINE COVER TESSUTO

Design R&D Poliform

Aperture

- B Battente
- C Coplanare

Finiture anta

Tessuto lino chiaro
Tessuto lino scuro

Finiture telaio e profili

Ardesia opaco
Champagne opaco

Maniglia - finiture

Fitted - ardesia opaco
Fitted - champagne opaco

Openings

- B Leaf door
- C Coplanar door

Door finishings

Fabric lino chiaro
Fabric lino scuro

Frame and profiles finishings

Mat ardesia
Mat champagne

Handle - finishings

Fitted - mat ardesia
Fitted - mat champagne

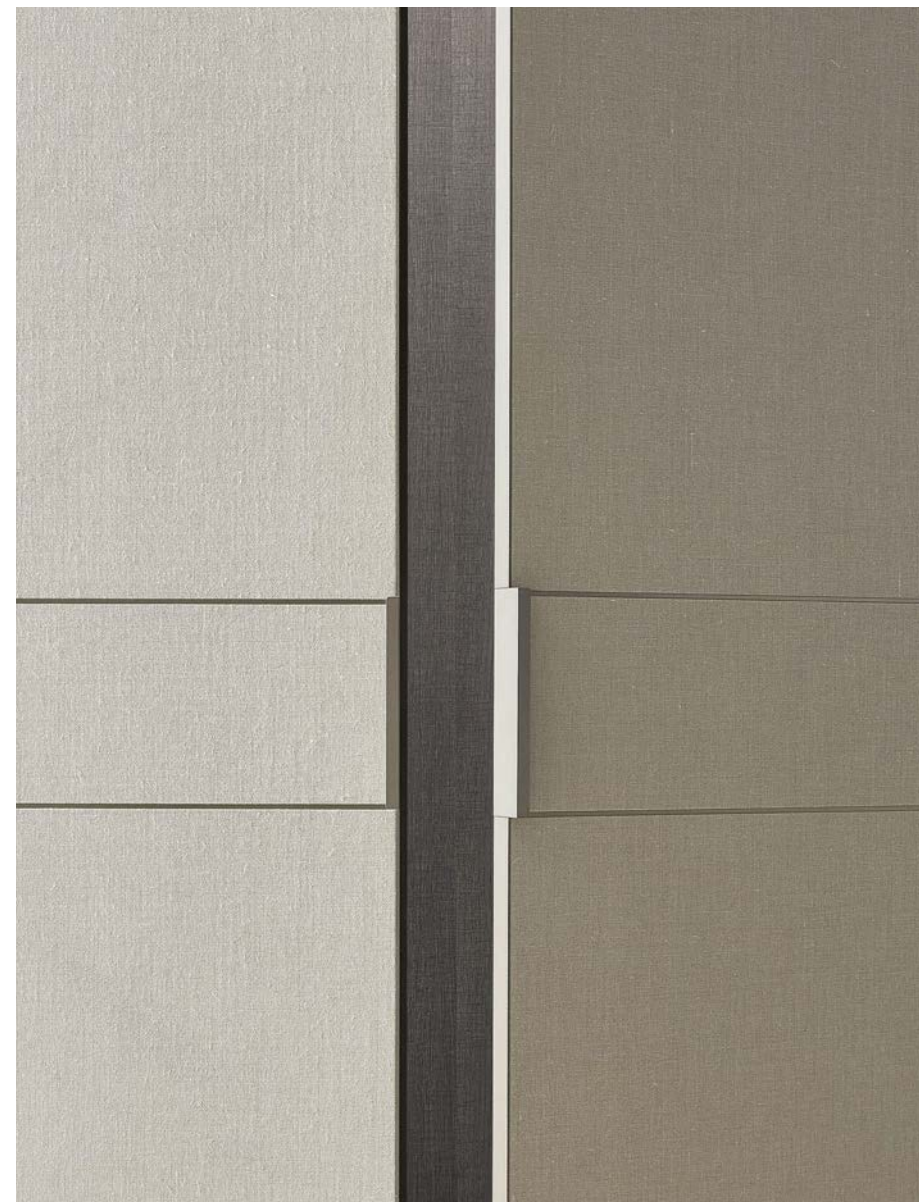
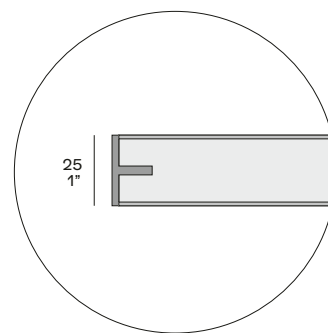

SENZAFINE COVER VETRO

Design R&D Poliform

Aperture

- B Battente
- C Coplanare

Finiture anta

Vetro lucido 6 colori
Vetro satinato 6 colori
Vetro acidato 3 colori
Vetro riflettente blu 5010
Specchio bianco 4000
(anta battente con interno laccato stesso colore del telaio, anta coplanare con interno in nobilitato bianco)

Finiture telaio e profili

Ardesia opaco
Champagne opaco

Maniglia - finiture

Fitted - ardesia opaco
Fitted - champagne opaco

Openings

- B Leaf door
- C Coplanar door

Door finishings

Glossy glass 6 colours
Mat glass 6 colours
Etched glass 3 colours
Blu reflecting glass 5010
White mirror 4000
(leaf door with inner side in the same colour of the frame, coplanar door with inner side in white melamine)

Frame and profiles finishings

Mat ardesia
Mat champagne

Handle - finishings

Fitted - mat ardesia
Fitted - mat champagne

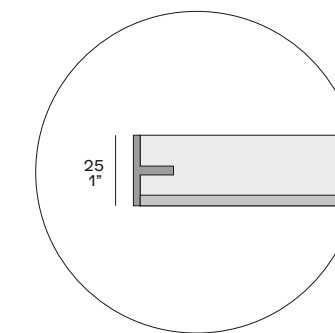

SENZAFINE BANGKOK

Design Operadesign

Aperture

- B Battente
- C Coplanare

Finiture anta

Cuoio colori

Finiture maniglia integrata

- Ardesia opaco
- Champagne opaco
- Brown nickel opaco
- Brown nickel lucido

Openings

- B Leaf door
- C Coplanar door

Door finishings

Hide colours

Integrated handle finishings

- Mat ardesia
- Mat champagne
- Mat brown nickel
- Glossy brown nickel

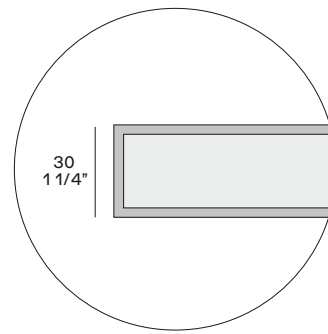

FINITURE SENZAFINE
SENZAFINE FINISHINGS

Struttura
Structure



olmo - elm
nobilitato - melamine

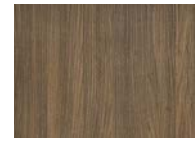

noce c. - walnut c.
nobilitato - melamine



rovere cenere
cenere oak
nobilitato - melamine



rovere spessart
spessart oak
nobilitato - melamine



canvas beige
nobilitato - melamine



canvas grigio
nobilitato - melamine



ardesia
nobilitato - melamine

Schienale
Back



olmo - elm
nobilitato - melamine



noce c. - walnut c.
nobilitato - melamine



rovere cenere
cenere oak
nobilitato - melamine



rovere spessart
spessart oak
nobilitato - melamine



canvas beige
nobilitato - melamine



canvas grigio
nobilitato - melamine

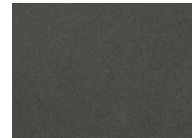

ardesia
nobilitato - melamine



roller latte
metacrilato
methacrylate



roller ardesia
metacrilato
methacrylate



skin
nobilitato - melamine
27 colori laccato opaco
27 mat lacquered colours

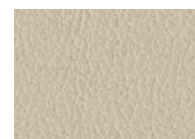

skin 94 latte
nobilitato - melamine
laccato opaco
mat lacquered

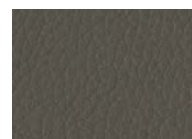

skin 97 elefante
nobilitato - melamine
laccato opaco
mat lacquered



skin 93 moro
nobilitato - melamine
laccato opaco
mat lacquered



skin 98 nocciola
nobilitato - melamine
laccato opaco
mat lacquered

Schienale vetro e fianco vetro
Glass back and glass side

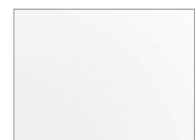

1000
trasparente
transparent



3050 fumé

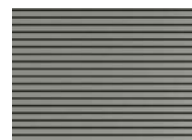

2700 line

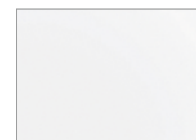

5000
trasparente riflettente
transparent reflecting



5051
bronzato riflettente
bronzed reflecting

Attrezzatura
Equipment



olmo - elm
nobilitato - melamine

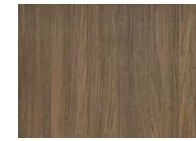

noce c. - walnut c.
nobilitato - melamine



rovere cenere
cenere oak
nobilitato - melamine



rovere spessart
spessart oak
nobilitato - melamine



canvas beige
nobilitato - melamine



canvas grigio
nobilitato - melamine



ardesia
nobilitato - melamine

Ripiani tecnopelle
Techno leather shelves

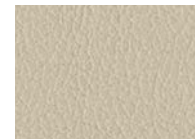

05 latte
tecnopelle
techno leather

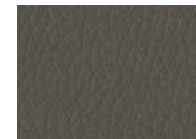

01 elefante
tecnopelle
techno leather



02 moro
tecnopelle
techno leather



06 nocciola
tecnopelle
techno leather

Ripiani vetro
Glass shelves



3050 fumé

Frontale cassetti
Drawers front



olmo - elm
nobilitato - melamine

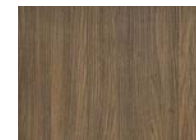

noce c. - walnut c.
nobilitato - melamine



rovere cenere
cenere oak
nobilitato - melamine



rovere spessart
spessart oak
nobilitato - melamine

* Finitura roller anche per frontali
vassoi portaoggetti e portapan-
taloni degli elementi sospesi.
Finish roller also for trays and
trousers hangers fronts of the
hanging units.

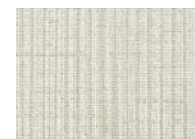

canvas beige
nobilitato - melamine

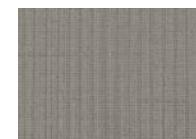

canvas grigio
nobilitato - melamine

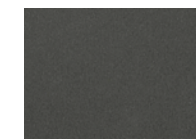

ardesia
nobilitato - melamine



roller latte
metacrilato
methacrylate *



roller ardesia
metacrilato
methacrylate *



5059
vetro riflettente fumé
fumé reflecting glass

Interno cassetti
Drawers interior

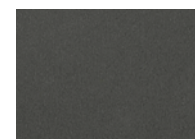

ardesia
nobilitato - melamine

Parti metalliche, ferramenta
Metal parts, hardware

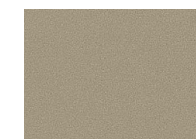

champagne opaco
mat champagne

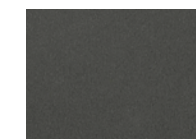

ardesia opaco
mat ardesia

FINITURE ANTE SENZAFINE
DOORS SENZAFINE FINISHINGS

Laccato opaco
Mat lacquered

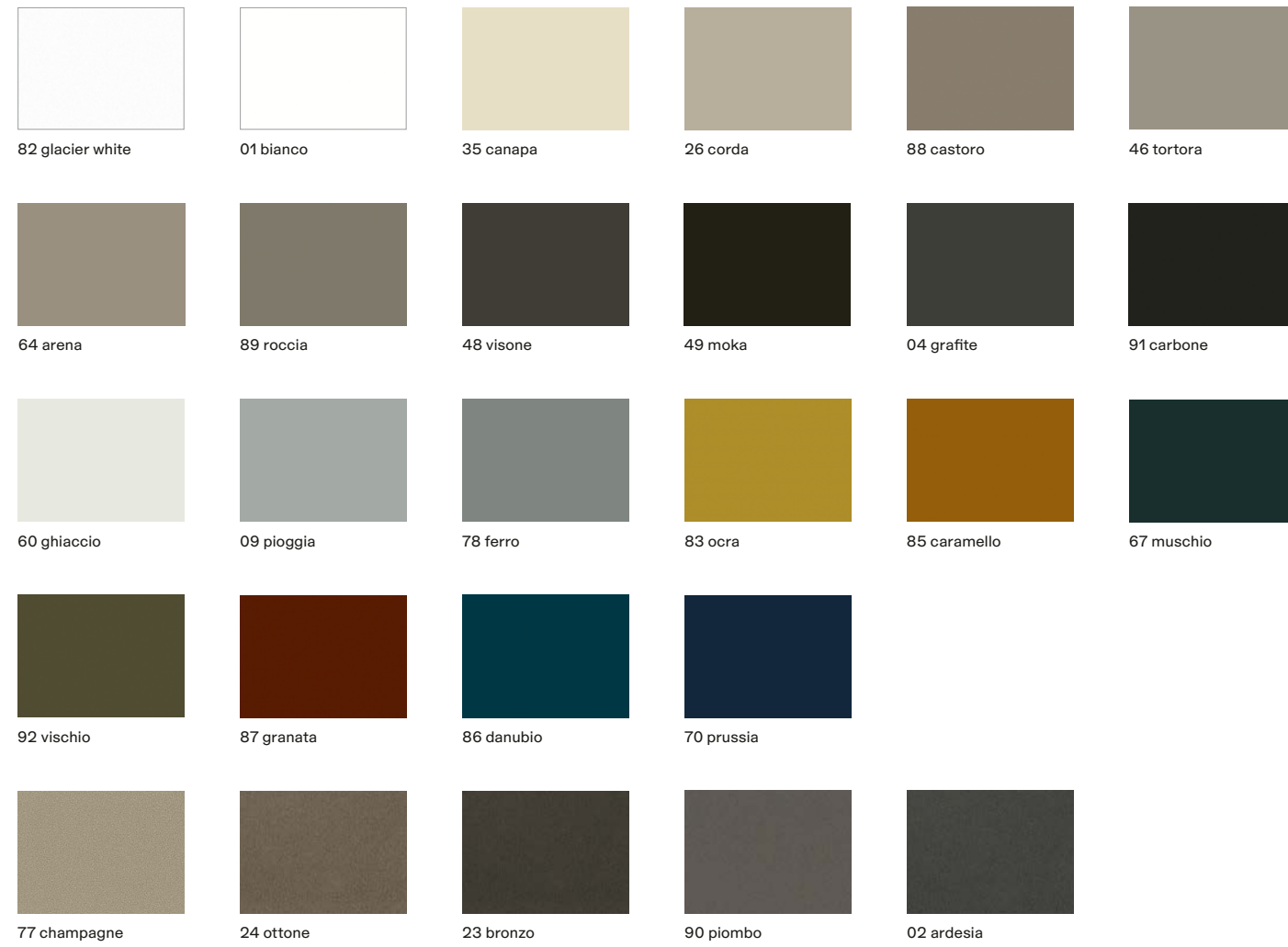

Laccato lucido
Glossy lacquered



Laccato semilucido
Semi-glossy lacquered



Laccato metallico
Metallic lacquered



Essenza
Wood

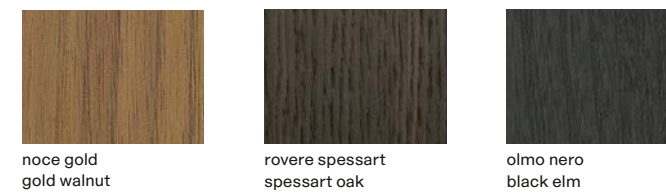

Nobilitato
Melamine

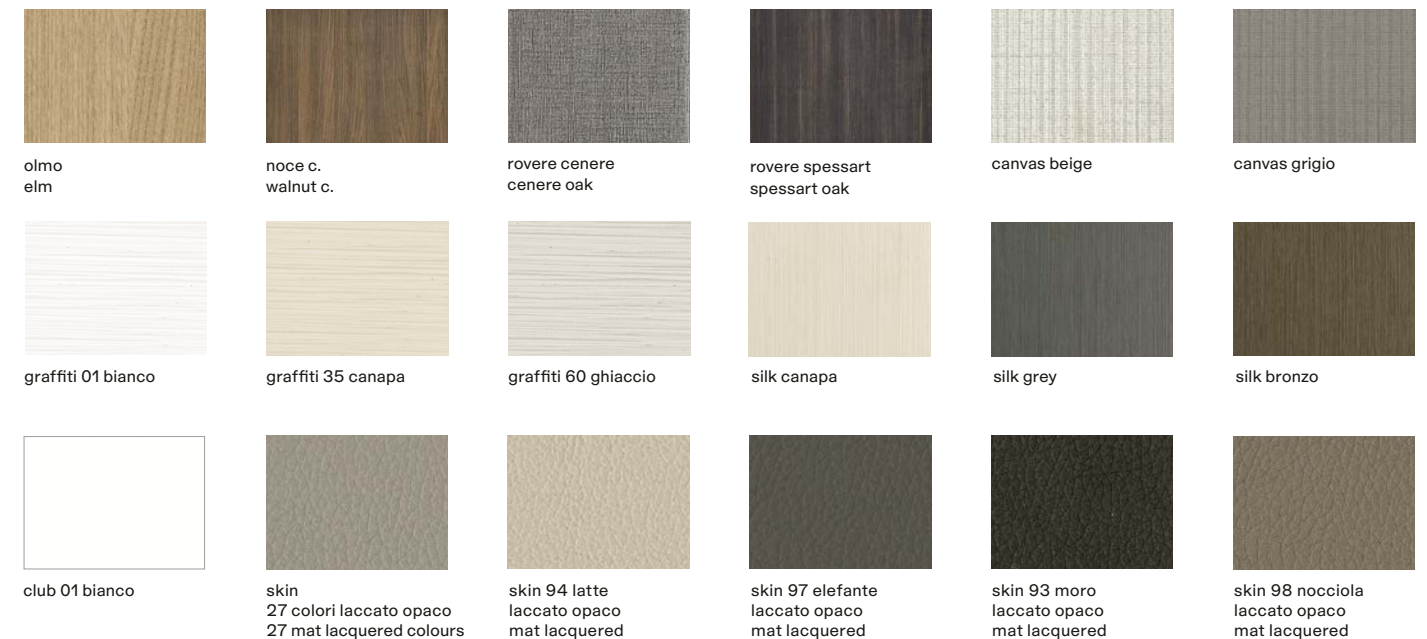

FINITURE ANTE SENZAFINE
DOORS SENZAFINE FINISHINGS

Tecnopelle
Techno leather



05 latte 01 elefante 02 moro 06 nocciola

Tessuto
Fabric



lino chiaro lino scuro

Cuoio
Hide



28 avorio 29 tortora 19 caffè 38 oliva 15 prugna 26 invecchiato



03 grigio scuro 02 nero

Vetro
Glass



1000 trasparente transparent
2000 trasparente extrachiaro-transparent extralight
3050 fumé
2700 line

Vetro riflettente
Reflecting glass



5000 trasparente transparent
5010 blu
5051 bronzato bronzed

Vetro acidato
Etched glass

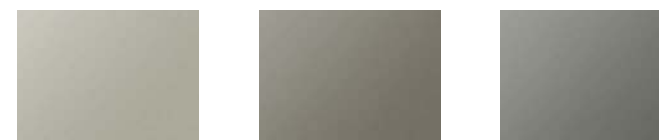

5380 acciaio 5323 bronzo 5325 titanio

Specchio
Mirror

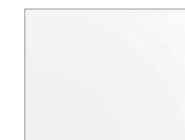

4000 bianco white

Vetro satinato
Mat glass



2301 bianco 2373 ghiaccio 1335 canapa 1364 arena 1304 grafite 1303 nero

Vetro lucido
Glossy glass



2201 bianco 2273 ghiaccio 1235 canapa 1264 arena 1204 grafite 1203 nero

**UBIK CABINA ARMADIO
UBIKW WALK-IN CLOSET**

Ubik è un sistema di pannellature che rivestono le pareti, completate da un'ampia varietà di attrezzature. Le pannellature schienale portante sono comprensive di cremagliera per il fissaggio a muro e per il posizionamento delle attrezzature. La possibilità di posizionare le attrezzature all'altezza desiderata conferma la flessibilità del sistema.

La pannellatura schienale può essere sostituita da profili con cremagliera, fissati a muro e completati dall'attrezzatura. Il sistema inoltre prevede tagli a misura in altezza su pannellature e profili con cremagliera, tagli a misura in larghezza su pannellature, fasce di aggiustaggio, composizioni ad angolo con attrezzatura lineare e soluzioni ad angolo anche per pareti con angoli fuori squadra.

Ubik is a system of wall panelling completed by a wide variety of equipments. The self-bearing panels include the metal frame for wall fitting and for equipments positioning.

The possibility of a free positioning in height of the equipment confirms the flexibility of the system.

The wall mounted panels can be replaced by wall fitted metal profiles which can be completed by the equipments. The panels and the metal brackets can be customized in height, the panels and the filler pieces can be customized in width, the system allows corner compositions with equipment and solutions for out of square corners.

Ubik pannellatura a muro

Per ottenere la larghezza totale, aggiungere alla somma degli schienali mm 32 relativi al profilo laterale iniziale, mm 4 per ogni cremagliera e mm 32 relativi al profilo laterale terminale.

Ubik wall panelling

To obtain the total width, add up the back panel widths 1 1/4" for the initial lateral profile, 1/4" for each rack and 1 1/4" for the ending lateral profile.

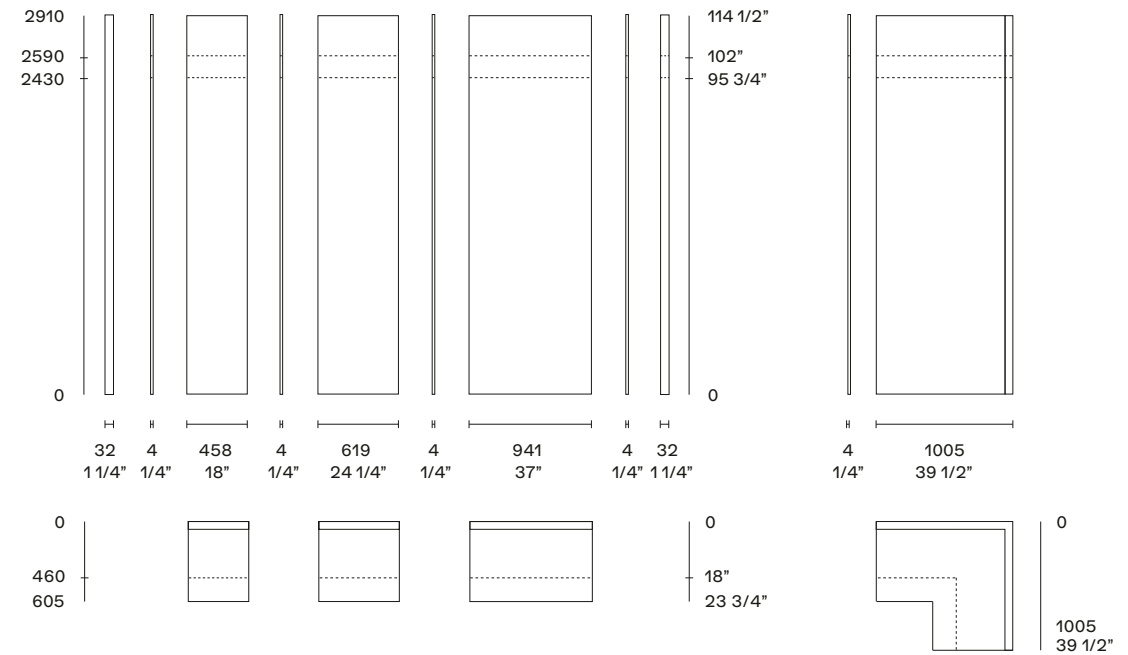

Ubik profilo con cremagliera

Per ottenere la larghezza totale, aggiungere alla somma delle larghezze dei ripiani mm 24 relativi al profilo laterale iniziale, mm 4 per ogni cremagliera e mm 24 relativi al profilo laterale terminale.

Ubik profile with rack

To obtain the total width, add up the shelves widths, 1" for the initial lateral profile, 1/4" for each rack and 1" for the ending lateral profile.

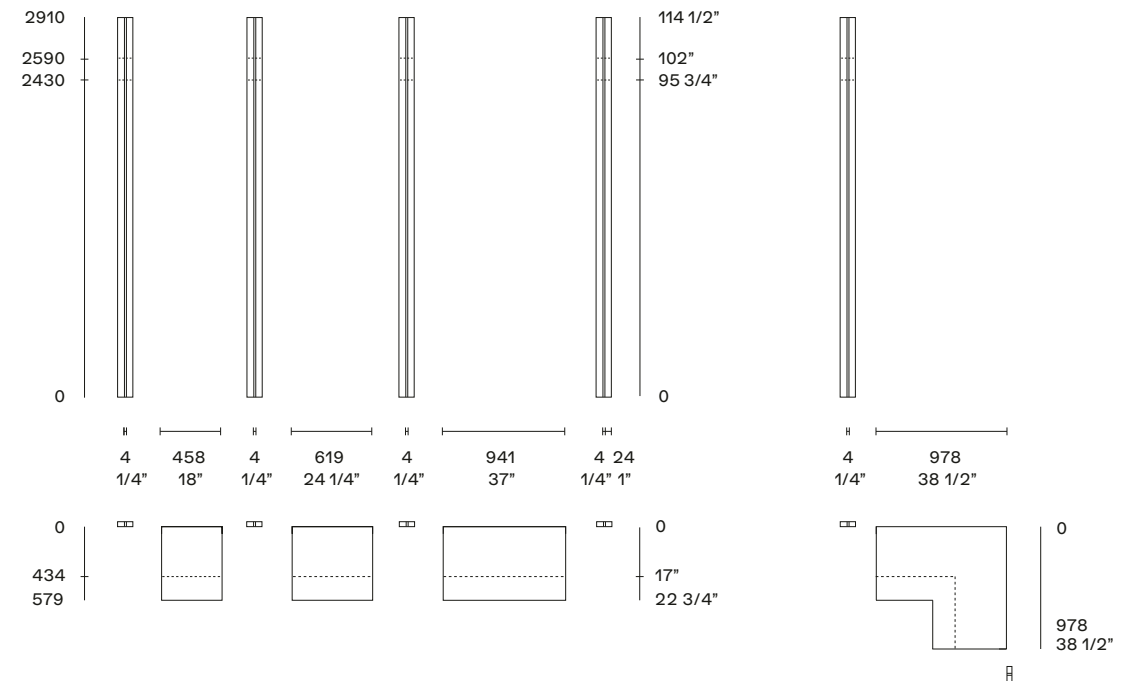

UBIK ORGANIZZAZIONE DEGLI INTERNI
UBIK INNER ORGANISATION

Attrezzature cabina armadio h 2590

- | | | |
|---|--|---|
| <p>1 1 ripiano
1 tubo appendiabiti
2 scatole larghezza mm 400
Contenitore porta scarpe con cassetti rivestiti in tessuto
Cassettiera a terra 2 cassetti legno e 1 cassetto alto legno, maniglia Track</p> <p>2 2 ripiani
2 tubi appendiabiti</p> <p>3 4 ripiani
3 scatole larghezza mm 260
3 ripiani portascarpe inclinati</p> <p>4 2 ripiani
1 tubo appendiabiti
2 scatole larghezza mm 400
Cassettiera su ruote 4 cassetti legno, maniglia Step</p> | <p>5 1 ripiano
1 tubo appendiabiti
Cassettiera a vetrina
Cassettiera sospesa 2 cassetti vetro, maniglia Track</p> <p>6 1 ripiano
1 tubo appendiabiti
Cassettiera a vetrina
Portapantaloni con vassoio portaoggetti, maniglia Track</p> <p>7 1 ripiano
1 tubo appendiabiti
1 svuotatasche
Cassettiera a terra 4 cassetti vetro, maniglia Track</p> <p>8 2 ripiani
1 servetto
Vassoio portaoggetti</p> | <p>9 2 ripiani
1 tubo appendiabiti
Portapantaloni con vassoio portaoggetti, maniglia Step</p> <p>10 2 ripiani
1 tubo appendiabiti
Contenitore portacamicie con cassetti alti e bassi rivestiti in tessuto
Cassettiera sospesa 2 cassetti legno, maniglia Track</p> <p>11 2 ripiani
1 tubo appendiabiti
Cassettiera sospesa con 2 vassoi
2 scatole larghezza mm 400</p> <p>12 4 ripiani
1 tubo appendiabiti
Contenitore portaborse</p> |
|---|--|---|

Walk-in closet equipment h 102"

- | | | |
|--|---|--|
| <p>1 2 shelves
2 hanging rails</p> <p>2 1 shelf
1 hanging rail
2 boxes width 15 3/4"
Shoes storage with drawers covered in fabric
Freestanding chest of drawers with 2 wooden drawers and 1 high wooden drawer, Track handle</p> <p>3 4 shelves
3 boxes width 10 1/4"
3 inclined shoes shelves</p> <p>4 2 shelves
1 hanging rail
2 boxes width 15 3/4"
Chest of drawers on casters 4 wooden drawers, Step handle</p> | <p>5 1 shelf
1 hanging rail
Showcase chest of drawers
Hanging chest of drawers with 2 glass drawers, Track handle</p> <p>6 1 shelf
1 hanging rail
Showcase chest of drawers
Trousers hanger with storage tray, Track handle</p> <p>7 1 shelf
1 hanging rail
1 jewellery tray
Freestanding chest of drawers with 4 glasses drawers, Track handle</p> <p>8 2 shelves
1 pull down hanging bar
Storage tray</p> | <p>9 2 shelves
1 hanging rail
Trousers hanger with storage tray, Step handle</p> <p>10 2 shelves
1 hanging rail
Shirts storage with high and low drawers covered in fabric
Hanging chest of drawers with 2 wooden drawers, Track handle</p> <p>11 2 shelves
1 hanging rail
Hanging chest of drawers with 2 trays
2 boxes width 15 3/4"</p> <p>12 4 shelves
1 hanging rail
Handbags storage</p> |
|--|---|--|

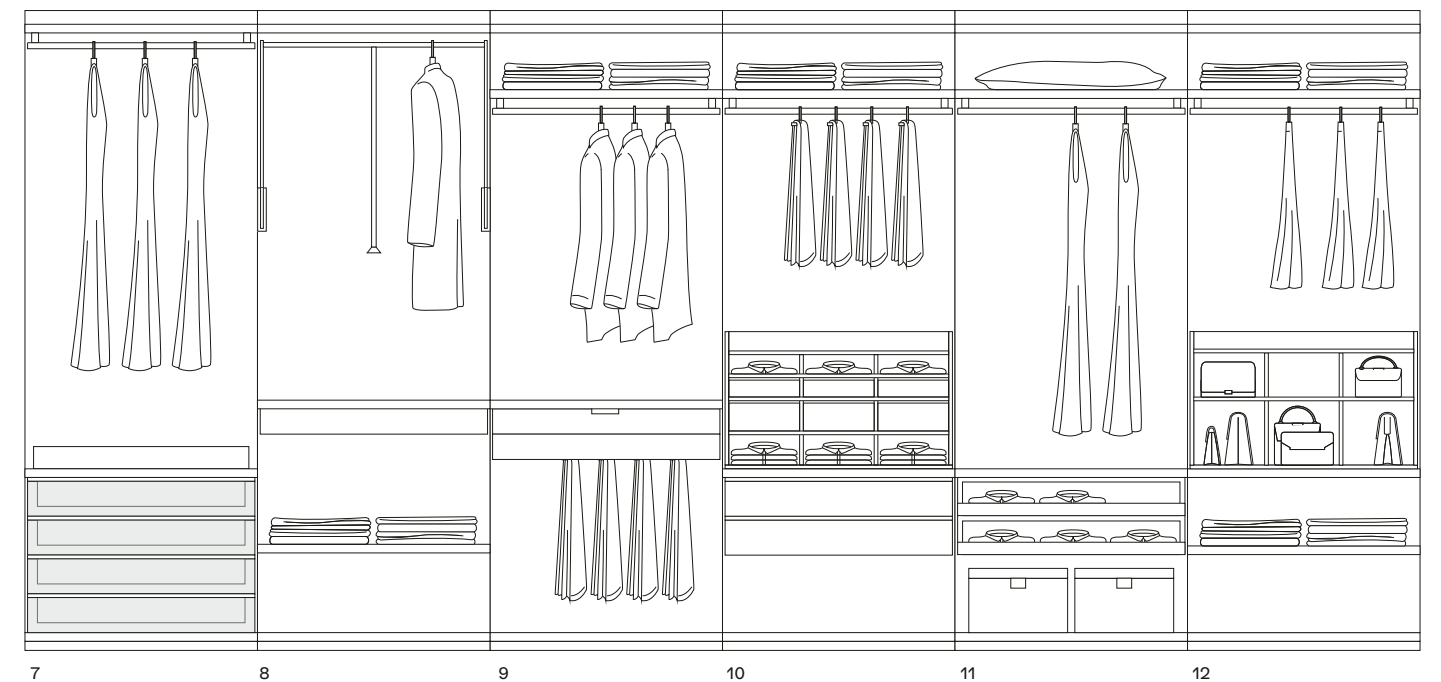
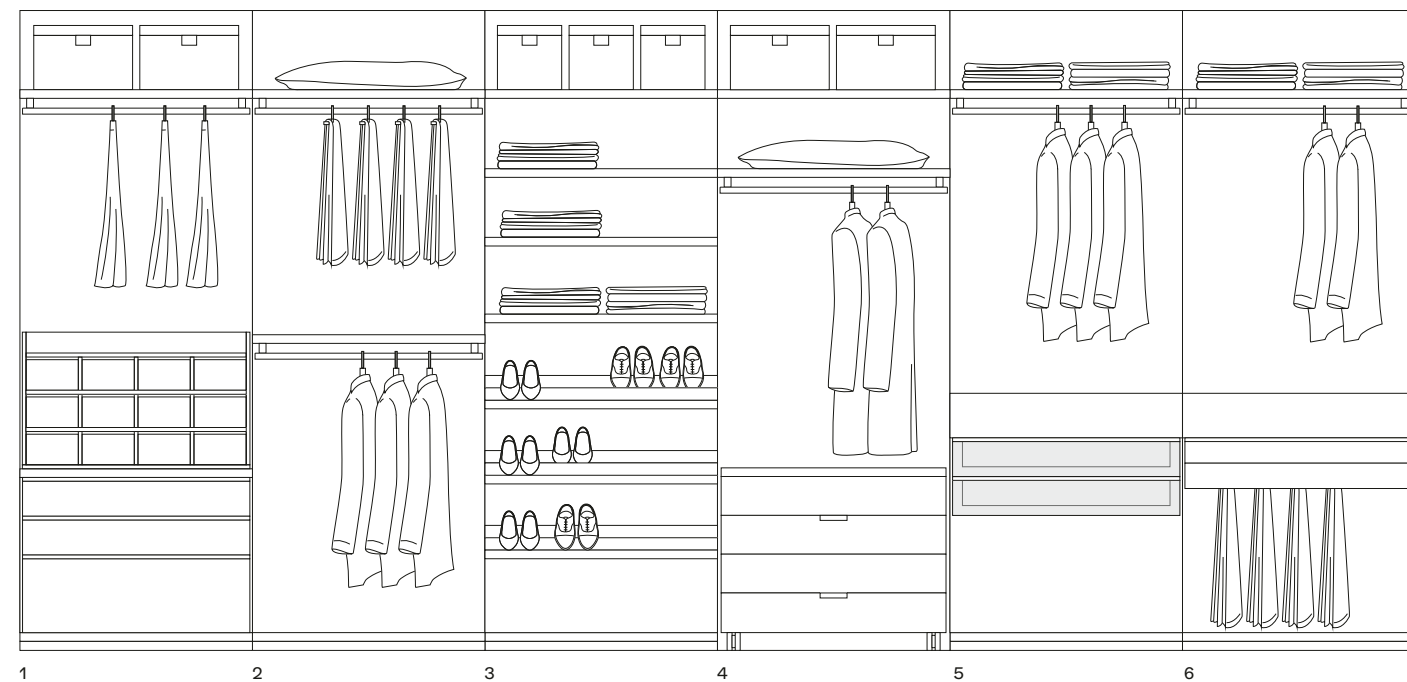

FINITURE UBIK
UBIK FINISHINGS

**Pannellatura
Panelling**



olmo - elm
nobilitato - melamine



noce c. - walnut c.
nobilitato - melamine



rovere cenere
cenere oak
nobilitato - melamine



rovere spessart
spessart oak
nobilitato - melamine



canvas beige
nobilitato - melamine

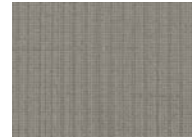

canvas grigio
nobilitato - melamine



ardesia
nobilitato - melamine



roller latte
metacrilato
methacrylate



roller ardesia
metacrilato
methacrylate



skin
nobilitato - melamine
27 colori laccato opaco
27 mat lacquered colours

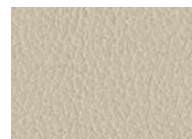

skin 94 latte
nobilitato - melamine
laccato opaco
mat lacquered

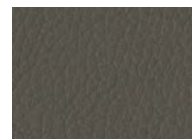

skin 97 elefante
nobilitato - melamine
laccato opaco
mat lacquered



skin 93 moro
nobilitato - melamine
laccato opaco
mat lacquered



skin 98 nocciola
nobilitato - melamine
laccato opaco
mat lacquered

**Pannellatura vetro
Glass panelling**

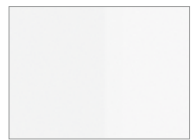

2201 bianco extralight
vetro lucido
glossy glass



2273 ghiaccio
vetro lucido
glossy glass



1235 canapa
vetro lucido
glossy glass



1264 arena
vetro lucido
glossy glass



1204 grafite
vetro lucido
glossy glass

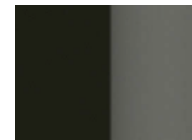

1203 nero
vetro lucido
glossy glass

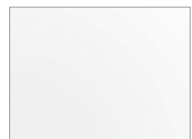

4000 specchio bianco
white mirror



5380 acciaio
vetro acidato
etched glass



5323 bronzo
vetro acidato
etched glass



5325 titanio
vetro acidato
etched glass

**Profili con cremagliera
Profile with rack**

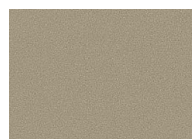

champagne opaco
mat champagne

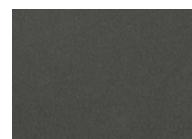

ardesia opaco
mat ardesia

**Attrezzatura
Equipment**



olmo - elm
nobilitato - melamine

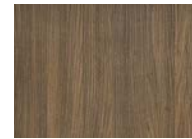

noce c. - walnut c.
nobilitato - melamine



rovere cenere
cenere oak
nobilitato - melamine



rovere spessart
spessart oak
nobilitato - melamine



canvas beige
nobilitato - melamine



canvas grigio
nobilitato - melamine

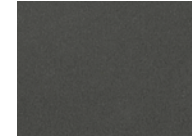

ardesia
nobilitato - melamine

**Ripiani tecnopelle
Techno leather shelves**

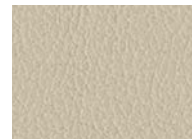

05 latte
tecnopelle
techno leather

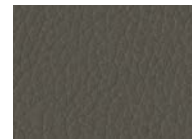

01 elefante
tecnopelle
techno leather



02 moro
tecnopelle
techno leather



06 nocciola
tecnopelle
techno leather

**Ripiani vetro
Glass shelves**



3050 fumé

**Frontale cassetti
Drawers front**



olmo - elm
nobilitato - melamine

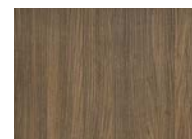

noce c. - walnut c.
nobilitato - melamine



rovere cenere
cenere oak
nobilitato - melamine



rovere spessart
spessart oak
nobilitato - melamine

* Finitura roller anche per frontali
vassoi portaoggetti e portapan-
taloni degli elementi sospesi.
Finish roller also for trays and
trousers hangers fronts of the
hanging units.



canvas beige
nobilitato - melamine

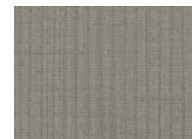

canvas grigio
nobilitato - melamine

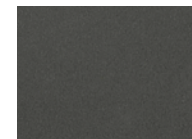

ardesia
nobilitato - melamine



roller latte
metacrilato
methacrylate *



roller ardesia
metacrilato
methacrylate *



5059
vetro riflettente fumé
fumé reflecting glass

**Interno cassetti
Drawers interior**

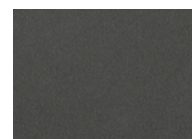

ardesia
nobilitato - melamine

**Parti metalliche, ferramenta
Metal parts, hardware**

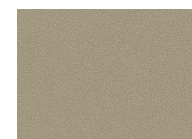

champagne opaco
mat champagne

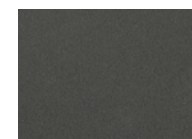

ardesia opaco
mat ardesia

CASSETTIERE A ISOLA ISLAND CHESTS OF DRAWERS

Senzafine

design R&D Poliform

Cassettiere a isola disponibili in tre altezze, due profondità e componibili in larghezza con fianchi spessore mm 35 e strutture attrezzabili, disponibili in cinque larghezze. Profondità mm 584 con schienale finito sul retro. Profondità mm 1131 con cassetti da entrambi i lati. Le strutture possono essere attrezzate con cassetti nobilitato o vetro, vassoio o vassoio portascarpe, in tutte le varianti di finiture previste dal sistema Senzafine.

Il top di spessore mm 35 prevede una lunghezza massima di mm 2910.

Struttura disponibile in sette varianti di nobilitato, top in sette varianti di nobilitato o in tecnopelle quattro colori con telaio in ardesia opaco o champagne opaco. Zoccolo in ardesia opaco o champagne opaco.

Island chests of drawers available in three heights, two depths and customizable in width with sides thickness mm 35 and accessorized structures available in five widths.

Depth 23" with back panel finished on the back. Depth 44 1/2" with drawers on both sides. The structures can be accessorized with melamine or glass drawers, trays or shoe tray in all the finishes available in the Senzafine system.

The top thickness 1 1/2" has a maximum length of 114 1/2".

Structure available in seven melamine finishes, top in seven melamine finishes or in technoleather in four colours with frame in mat ardesia or mat champagne. Plinth in mat ardesia or mat champagne.

Altezza e larghezza Height and width

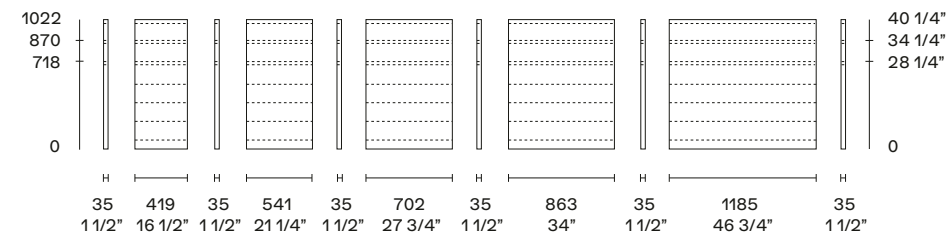

Per ottenere la larghezza totale, aggiungere alla somma delle strutture (disponibili in 5 larghezze) mm 70 relativi ai due fianchi laterali e mm 35 per ogni fianco centrale.

To obtain the total width, add to the sum of the structure (available in 5 widths) 2 3/4" for the two lateral sides and 1 1/2" for every central side.

Profondità Depth

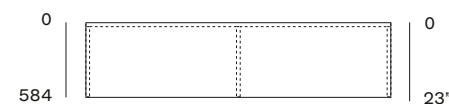

Fronte con cassetti, retro con schienale finito.

Front with drawers, back with finished back panel.

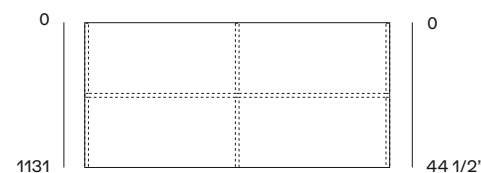

Cassetti su entrambi i lati.

Drawers on both sides.

Set-Up

design Rodolfo Dordoni

Cassettiere a isola disponibili in due dimensioni. Struttura e frontali cassetti in laccato opaco ardesia o champagne.

Top in tecnopelle quattro colori e vetro fumé. Zoccolo in ardesia opaco o champagne opaco.

Su entrambi i lati lunghi, vano a giorno con ripiano in vetro fumé, un cassetto superiore e due cassetti inferiori con piano in tecnopelle quattro colori.

Sul lato corto, cassettiera a vetrina con piano superiore in vetro fumé, cassetto con frontale laccato opaco ardesia o champagne e piano in tecnopelle quattro colori.

Nella parte inferiore quattro cassetti laccati o in vetro riflettente fumé. Maniglia Track in ardesia opaco o champagne opaco.

Maniglia Step in ardesia opaco o champagne opaco e tecnopelle quattro colori. Rivestimento opzionale fondi cassetti in tecnopelle quattro colori.

Vani a giorno e cassettiera a vetrina con luce led opzionale.

Island chests of drawers available in two sizes. Structure and drawer fronts mat lacquered ardesia or champagne.

Top in technoleather four colours and fumé glass. Plinth in mat ardesia or mat champagne.

On both long sides, open compartment with shelf in fumé glass, one upper drawer and two lower drawers with top in technoleather in four colours.

On the short side, showcase chest of drawers with top in fumé glass, drawer with ardesia or champagne mat lacquered front and top in technoleather in four colours.

In the lower part, four drawers in lacquer or in fumé reflecting glass. Track handle in mat ardesia or in mat champagne. Step handle in mat ardesia or mat champagne and technoleather in four colours.

Optional cover of the drawers bottom in technoleather in four colours. Open compartments and showcase chest of drawers with optional led light.

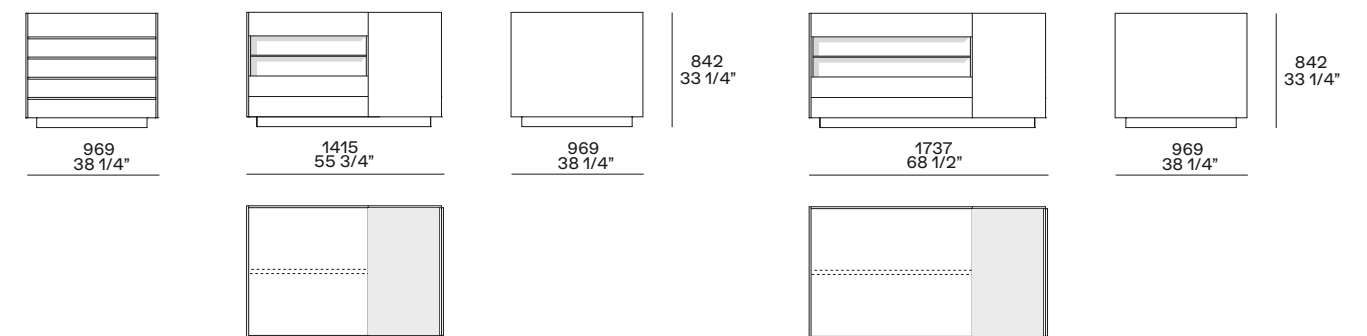

Varianti cassetti Drawers typologies

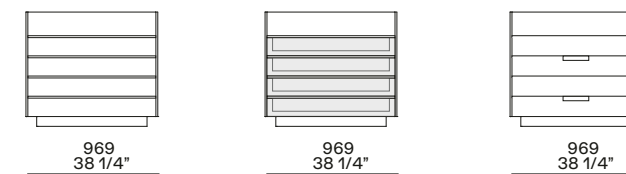

Cassetti legno, maniglia Track.

Wooden drawers, Track handle.

Cassetti vetro, maniglia Track.

Glass drawers, Track handle.

Cassetti legno, maniglia Step.

Wooden drawers, Step handle.

FINITURE CASSETTIERE A ISOLA SENZAFINE
ISLAND CHESTS OF DRAWERS SENZAFINE FINISHINGS

Struttura, schienale e top
Structure, back and top



olmo - elm
nobilitato - melamine

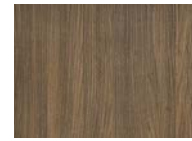

noce c. - walnut c.
nobilitato - melamine

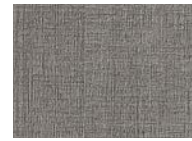

rovere cenere
cenere oak
nobilitato - melamine

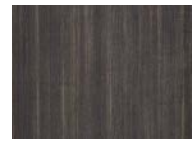

rovere spessart
spessart oak
nobilitato - melamine



canvas beige
nobilitato - melamine



canvas grigio
nobilitato - melamine



ardesia
nobilitato - melamine

Top e fondo opzionale cassetti
Top and optional drawers bottom



05 latte
tecnopelle
techno leather

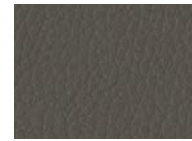

01 elefante
tecnopelle
techno leather



02 moro
tecnopelle
techno leather



06 nocciola
tecnopelle
techno leather

Frontale cassetti
Drawers front



olmo - elm
nobilitato - melamine

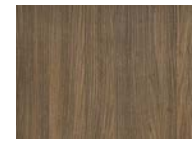

noce c. - walnut c.
nobilitato - melamine



rovere cenere
cenere oak
nobilitato - melamine



rovere spessart
spessart oak
nobilitato - melamine



canvas beige
nobilitato - melamine



canvas grigio
nobilitato - melamine



ardesia
nobilitato - melamine



roller latte
metacrilato
methacrylate



roller ardesia
metacrilato
methacrylate



5059
vetro riflettente fumé
fumé reflecting glass

Interno cassetti
Drawers interior

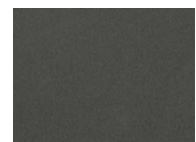

ardesia
nobilitato - melamine

Parti metalliche, ferramenta
Metal parts, hardware

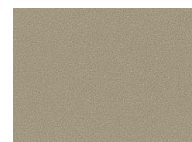

champagne opaco
mat champagne

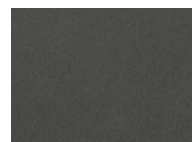

ardesia opaco
mat ardesia

FINITURE CASSETTIERE A ISOLA SET-UP
ISLAND CHESTS OF DRAWERS SET-UP FINISHINGS

Struttura e frontale cassetti
Structure and drawers front

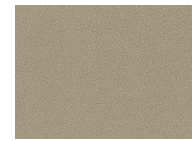

77 champagne
laccato opaco
mat lacquered



02 ardesia
laccato opaco
mat lacquered

Frontale cassetti vetro
Glass drawers front



5059
vetro riflettente fumé
fumé reflecting glass

Top e fondo opzionale cassetti
Top and optional drawers bottom



05 latte
tecnopelle
techno leather



01 elefante
tecnopelle
techno leather



02 moro
tecnopelle
techno leather



06 nocciola
tecnopelle
techno leather

Top e ripiano vano a giorno
Top and open compartment shelf



3050 fumé

Interno cassetti
Drawers interior

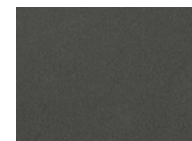

ardesia
nobilitato - melamine

Parti metalliche, ferramenta
Metal parts, hardware



champagne opaco
mat champagne

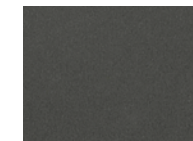

ardesia opaco
mat ardesia

Poliform Spa
via Montesanto 28
Casella postale n. 1
22044 Inverigo (CO) Italy
t +39 031 6951
f +39 031 699444
info@poliform.it
poliform.it



Poliform realizza tutte le sue collezioni in Italia usando componenti e materie prime selezionate.

All the Poliform collections are manufactured 100% in Italy using top-class components and materials.

Poliform si riserva il diritto di apportare, senza preavviso, ogni modifica mirata al miglioramento funzionale e qualitativo dei propri prodotti. Testi e disegni presenti in questo stampato hanno scopo divulgativo: per ogni aspetto tecnico e dimensionale fare riferimento ai listini aziendali e relativi aggiornamenti. I campioni di colori e materiali hanno valore indicativo.

Poliform reserves the rights at all time to apply modifications for the functional or qualitative improvement of its products. Texts and drawings present in this brochure have a divulgative purpose: for every technical and dimensional aspect please refer to the company's price lists and their relative updatings. The colour and material samples have an indicative value.

Creative Direction
Apartamento Studios

Graphic Design
Apartamento Studios

Interiors Photography
Federico Cedrone, Omar Sartor

Still Life Photography
Silvia Orlandi

Interiors Styling
Poliform Lab

1st edition March 2020
cod. 112/R1/2020



TWENTY TWENTY