

KITCHEN COLLECTION
2022

Poliform

Poliform

Poliform è una delle realtà più significative nel mondo dell'arredamento internazionale per qualità del design, eccellenza del progetto e innovazione. Il suo talento è il saper fare, una capacità che unisce cultura e conoscenza e che prima di essere un gesto, il gesto che rende riconoscibile tutto ciò che è firmato Poliform, è un'idea di progettazione. Un pensiero che unisce ricerca di funzionalità, contenuti espressivi e significati, e che della combinazione tra estetica e utilità ha saputo fare un'arte, in ogni area della casa. In cucina, quest'arte si esprime attraverso sistemi dal design eccellente, che rispondono alle esigenze delle persone e ne appagano i sensi, giorno dopo giorno.

Poliform is one of the most important companies in the world of international furniture for design quality, project excellence, and innovation. Its talent is the know-how, a skill that unites culture and knowledge and that, before being a gesture, the gesture that makes everything signed Poliform recognizable, it is a design idea. A thought that combines research of functionality, expressive contents, and meanings, and that has been able to make an art of the combination of aesthetics and utility, in every area of the house. In the kitchen, this art is expressed through systems with excellent design, which meet people's needs and satisfy their senses, day after day.



ART OF THE KITCHEN

La cucina è un luogo particolare, l'unico della casa che ha una funzione specifica: preparare i cibi. Tanti sono i modelli, tutti progettati per rendere più semplici i flussi di lavoro e mettere al centro le persone e le loro esigenze.

The kitchen is a particular place, the only one in the house that has a specific function: preparing food. There are many models, all designed to simplify workflows and put people and their needs at the centre.





Sciacquare, lavare, inumidire, bagnare, sbollentare.
In cucina l'acqua ha un ruolo di primo piano, così
come il lavello e i piani di lavoro, che si distinguono
per eccellenza tecnica e durabilità.

Rinsing, washing, dampening, wetting, boiling.
In the kitchen, water plays a leading role,
as does the sink and worktops, which stand
out for technical excellence and durability.

L'idea del cibo passa anche attraverso
l'atto della cottura e le sue mille declinazioni.
Per questo il fuoco e le sue evoluzioni più contemporanee,
tra materiali innovativi e accessori dedicati,
rappresentano il centro di ogni cucina.

The idea of food also passes through the
act of cooking and its thousands of variations.
This is why hobs and their most contemporary
evolutions, between innovative materials and dedicated
accessories, represent the centre of every kitchen.





Per conservarsi, il cibo ha bisogno di particolari condizioni di temperatura, illuminazione e umidità. O di soluzioni speciali come la cantina per il vino, che preserva profumi, colori e sensazioni gustative.

To be preserved, food needs special conditions of temperature, lighting, and humidity. Or special solutions like the wine cellar, which preserves aromas, colours and flavours.

L'attenzione alla qualità della vita si misura anche attraverso il silenzio e la pulizia dell'aria, due proprietà difficili da percepire che rendono molto più piacevole il tempo trascorso in cucina.

Attention to quality of life is also measured through silence and cleanliness of the air, two properties that are difficult to perceive that make the time spent in the kitchen much more pleasant.





Il segreto di ogni cucina è l'organizzazione, la perfetta interazione tra gli elementi che ne accresce l'utilità e migliora l'esperienza complessiva. Perché tutto è più semplice quando ogni cosa è a portata di mano, grazie a una varietà di attrezzature specifiche.

The secret of every kitchen is organization, the perfect interaction between the elements that increases its usefulness and improves the overall experience. Because everything is easier when everything is at hand, thanks to a variety of specific equipment.

La cucina nasconde dettagli di grande qualità come gli accessori, che moltiplicano spazi e funzionalità per rispondere a tutte le necessità di riordino e contenimento.

The kitchen hides details of great quality such as accessories, which multiply spaces and functionalities to meet all the needs of reorganization and storage.





In cucina l'ordine ha conquistato ogni ambito – all'insegna dell'attenzione all'ambiente e di una sensibilità ecologica che può avere un impatto concreto sul futuro, un gesto alla volta.

In the kitchen, order has conquered every area – in the name of attention to the environment and an ecological sensitivity that can have a concrete impact on the future, one gesture at a time.

Spezie, semi e legumi. Frutti dai colori vivi
e verdure dalle forme più strane.

La cucina è prima di tutto un luogo dove
la bellezza fa capolino dappertutto, anche da mensole
e Shaker – proposti in un'ampia gamma di finiture.

Spices, seeds, and legumes. Fruits with vivid colours
and vegetables with the strangest shapes.
The kitchen is first and foremost a place where beauty
peeks out from everywhere, including shelves
and Shakers – offered in a wide range of finishes.





In cucina non c'è spazio sprecato, né fuori né dentro i luoghi di contenimento, perché modularità e dimensioni sono ottimizzate in modo tale che ogni cosa abbia il suo posto.

In the kitchen there is no wasted space, neither outside nor inside the storage areas, because modularity and dimensions are optimized so that everything has its place.



Mangiare è un atto che coinvolge tutti i sensi con sapori, profumi, colori, suggestioni tattili e sensazioni uditive. La cucina è dunque lo spazio sensoriale per eccellenza, dove s'incontrano razionalità ed emozione e funzione ed estetica sono in perfetto equilibrio.

Eating is an act that involves all the senses with flavours, aromas, colours, tactile sensations, and sounds. The kitchen is therefore the sensory space par excellence, where rationality and emotion meet, and function and aesthetics are in perfect balance.

KITCHENS

Poliform propone cucine esclusive, capaci di cogliere le esigenze e i gusti di un pubblico eterogeneo e internazionale, caratterizzate da un'eccezionale versatilità compositiva e dall'infinita varietà di materiali e finiture. Collezioni differenti, pur nella perfetta coerenza di stile. Sistemi cucina realizzati interamente in Italia, così da garantire un accurato controllo di tutte le fasi produttive: dalla selezione di materiali di qualità alla cura del dettaglio, attraverso la continua ricerca di affidabilità, sicurezza e durata nel tempo. Cucine per case straordinarie, in perfetta sintonia con il progetto di stile Poliform, un progetto coordinato e completo che interpreta l'arredamento come un'esperienza totale.

Poliform offers exclusive kitchens, able to capture the needs and tastes of a heterogeneous and international audience, characterised by an exceptional compositional versatility and by the infinite variety of materials and finishes. Diverse collections, despite the perfect consistency of style. Kitchen systems made entirely in Italy, so as to ensure accurate control of all stages of production: from the selection of quality materials to the attention to detail, through the continuous search for reliability, safety, and durability. Kitchens for extraordinary homes, in perfect harmony with the Poliform project of style, a coordinated and complete project that interprets furniture as a comprehensive experience.

COLLECTIONS		
	SHAPE	35
	ARTEX	75
	PHOENIX	131
	ALEA PRO	173
	ALEA	287
	MY PLANET	313
	TWELVE	351
	TECHNICAL DATA	403

SHAPE



Shape è una cucina dall'apertura a maniglia ispirata, nel design contemporaneo e nella funzionalità, alle cucine senza maniglia. È caratterizzata dal particolare profilo rientrante, all'interno del quale è inserita la maniglia vera e propria. Il profilo, che nelle colonne assume l'aspetto di una modanatura a tutta altezza, nelle basi può integrare la maniglia al centro dell'anta o lateralmente.

Shape is a kitchen with a handle opening that draws inspiration from kitchens without handles in their contemporary design and functionality. It is characterized by the peculiar recessed profile, where the actual handle is hidden inside. The profile, which in the tall units takes the shape of a full-height moulding, in the base units can integrate the handle in the middle of the door or on the side.





Qui, nella pagina precedente e nelle successive: isola centrale con ante ed estrattori in acciaio scotch brite e maniglia integrata Shape in laccato opaco moka, piano e fianchi di finitura in acciaio scotch brite, piano con vaso in marmo noir saint laurent levigato. Snack Tape con piano e fianchi in massello tinto olmo nero. Sgabelli Sophie Lite in pelle sfoderabile Nabuk 08 prussia, struttura in olmo nero e poggiatesta in brown nickel opaco. Cappa Sail personalizzata Poliform in acciaio verniciato nero opaco e barra luminosa lunga come l'isola. Colonne High con ante ed estrattori in laccato goffrato roccia, maniglia integrata Shape orizzontale in laccato opaco moka. Deep Shaker Wall con struttura in anodizzato moka, schienale in olmo nero, tubi in laccato goffrato moka, piani in noce canaletto e barattoli in vetro e ceramica. Colonne con ante in laccato goffrato roccia e maniglia integrata Shape verticale in laccato opaco moka, una colonna attrezzata con cantina vini. Porta Pivot Plus vetro, portale e telaio con perni in laccato goffrato moka, porta in vetro riflettente fumé con maniglia Plus e telaio in moka opaco.

This, previous page and next pages: central island with doors and pull-out baskets in scotch brite steel, Shape integrated handle in mat lacquer moka, top and finishing sides in scotch brite steel, top with drip edge in mat marble noir saint laurent. Tape snack with top and sides in solid wood stained black elm. Sophie Lite stools in removable leather Nabuk 08 prussia, structure in black elm and footrest in mat brown nickel. Sail hood personalized Poliform in mat black painted steel and light bar as long as the island. High tall units with doors and pull-out baskets in roccia embossed lacquer, Shape integrated horizontal handle in mat lacquer moka. Deep Shaker Wall with anodized moka structure, back in black elm, bars in moka embossed lacquer, shelves in walnut canaletto and glass and ceramic jars. Tall units with roccia embossed lacquered doors and Shape integrated vertical handle in mat lacquer moka, one tall unit equipped with wine cellar. Pivot Plus glass door, portal and frame with pivots in moka embossed lacquer, door in fumé reflective glass with Plus handle and frame in mat moka.

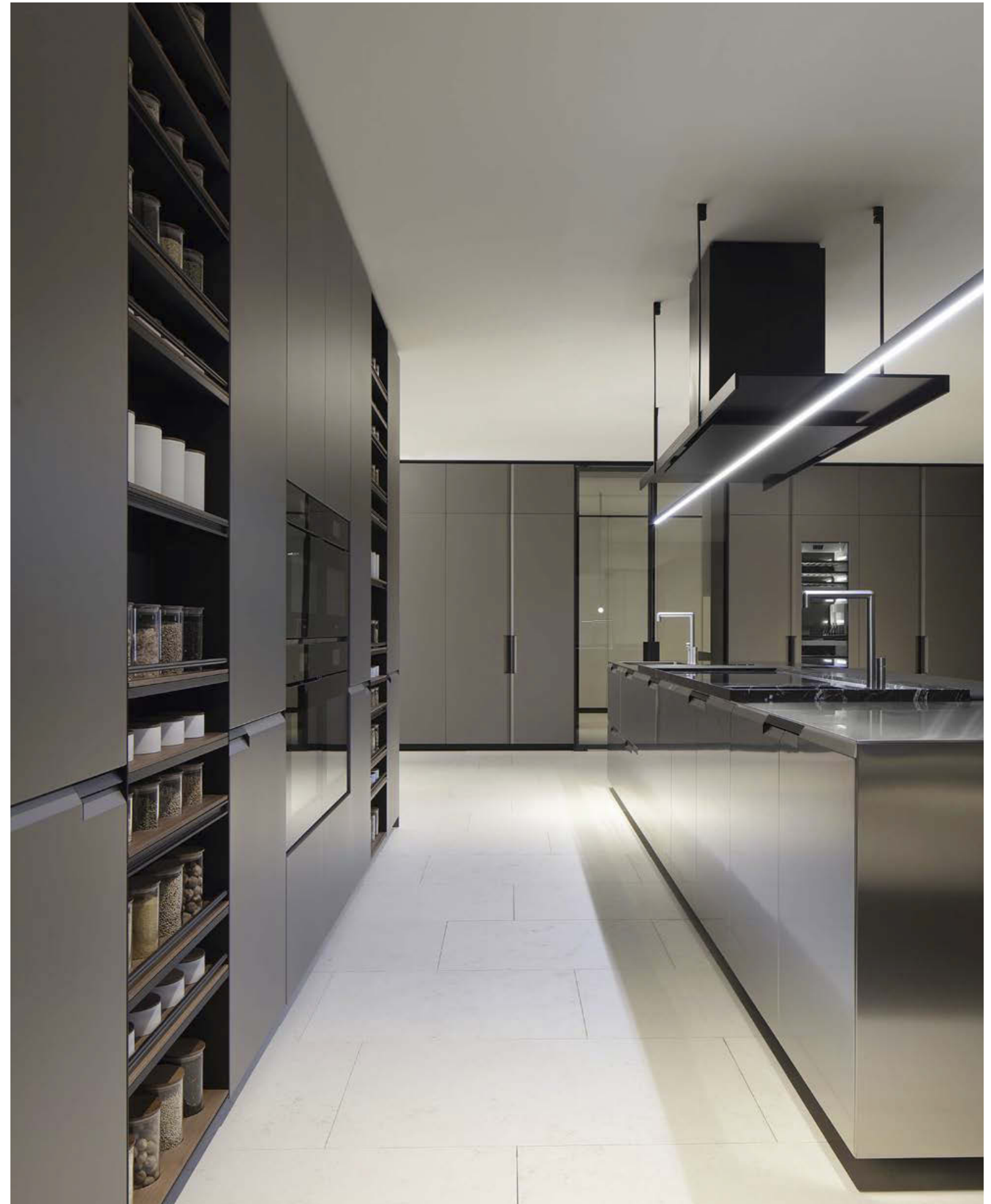



A sinistra: snack Tape integrato alle basi della cucina, progettato in perfetta continuità con il top.

Left: Tape snack top integrated with the kitchen base units, designed in perfect continuity with the worktop.

A destra: snack Tape con piano e fianchi in massello tinto olmo nero caratterizzati dai bordi arrotondati e abbinato alla cucina Shape con piano spessore 6 mm.

Right: Tape snack with top and sides in solid wood stained black elm distinguished by the rounded edges and in combination with Shape kitchen with 6 mm thick top.





A sinistra: dettaglio del sistema Deep Shaker Wall, pensato per inserirsi tra le colonne di qualsiasi modello di cucina Poliform. I contenitori a giorno hanno la struttura in anodizzato moka da attrezzare con gli stessi accessori di Deep Shaker: piani e barattoli in vetro e ceramica. Nella pagina successiva: isola centrale con ante ed estrattori in acciaio scotch brite e maniglia integrata Shape in laccato opaco moka, piano e fianchi di finitura in acciaio scotch brite, piano con vaso in marmo noir saint laurent levigato. Snack Tape con piano e fianchi in massello tinto olmo nero. Sgabelli Sophie Lite in pelle sfoderabile Nabuk 08 prussia, struttura in olmo nero e poggiatesta in brown nickel opaco. Cappa Sail personalizzata Poliform in acciaio verniciato nero opaco e barra luminosa lunga come l'isola. Colonne High con ante ed estrattori in laccato goffrato roccia, maniglia integrata Shape orizzontale in laccato opaco moka e Deep Shaker Wall. Colonne con ante in laccato goffrato roccia e maniglia integrata Shape verticale in laccato opaco moka, una colonna attrezzata con cantina vini. Porta Pivot Plus vetro, portale e telaio con perni in laccato goffrato moka, porta in vetro riflettente fumé e moka opaco.

Left: close-up of Deep Shaker Wall system, designed to fit between the tall units of any Poliform kitchen model. The open storage units have an anodized moka structure to be fitted out with the same accessories as the Deep Shaker: shelves and glass and ceramic jars. Next page: central island with doors and pull-out baskets in scotch brite steel, Shape integrated handle in mat lacquer moka, top and finishing sides in scotch brite steel, top with drip edge in mat marble noir saint laurent. Tape snack with top and sides in solid wood stained black elm. Sophie Lite stools in removable leather Nabuk 08 prussia, structure in black elm and footrest in mat brown nickel. Sail hood personalized Poliform in mat black painted steel and light bar as long as the island. High tall units with doors and pull-out baskets in roccia embossed lacquer, Shape integrated horizontal handle in mat lacquer moka and Deep Shaker Wall. Tall units with roccia embossed lacquered doors and Shape integrated vertical handle in mat lacquer moka, one tall unit equipped with wine cellar. Pivot Plus glass door, portal and frame with pivots in moka embossed lacquer, door in fumé reflective glass and mat moka.



A destra: sistema di porte Pivot che si integra con le colonne della collezione cucine. Il sistema è composto da un portale al quale viene fissato nella parte anteriore o posteriore il telaio con perni per l'aggancio delle porte con apertura a bilico. Le porte sono disponibili in vetro o in essenza, massello, laccato goffrato e laccato metallico per poter creare una continuità visiva con le colonne della cucina. In questa pagina e nella successiva: colonne con ante in laccato goffrato roccia e maniglia integrata Shape verticale in laccato opaco moka. Porta Pivot Plus vetro, portale e telaio con perni in laccato goffrato moka, porta in vetro riflettente fumé e moka opaco.

Right: Pivot door system which integrates with the tall units of the kitchen collection. The system consists of a portal to which the frame with pins for hooking the doors with pivot opening is fixed at the front or rear part. The doors are available in glass or in wood, solid wood, embossed lacquer and metal lacquer in order to create a visual continuity with the kitchen tall units. This and next page: tall units with roccia embossed lacquered doors and Shape integrated vertical handle in mat lacquer moka. Pivot Plus glass door, portal and frame with pivots in embossed lacquer moka, glass doors in fumé reflective glass and mat moka.





SHAPE

Design R&D Poliform

Isola p 1280

Strutture: nobilitato grigio perla.
 Ante ed estrattori: acciaio scotch brite.
 Maniglie: integrate Shape, laccato opaco moka.
 Fianchi: acciaio scotch brite Barazza, spessore 6 mm.
 Top: acciaio scotch brite Barazza, spessore 6 mm, con telaio di supporto in alluminio.
 Marmo noir saint laurent levigato spessore 40 mm, con involucro.
 Zoccoli: laccato goffrato moka.

Snack Tape

Piano e fianchi in massello tinto olmo nero.

Colonne High p 640

Strutture: nobilitato grigio lavagna.
 Ante ed estrattori: laccato goffrato roccia.
 Maniglie: integrate Shape, laccato opaco moka.

Deep Shaker Wall p 160

Strutture: anodizzato moka.
 Schienali: olmo nero.
 Tubi: laccato goffrato moka.

Colonne p 640

Strutture: nobilitato grigio lavagna.
 Ante ed estrattori: laccato goffrato roccia.
 Maniglie: integrate Shape, laccato opaco moka.

Porta Pivot Plus vetro

Portale e telaio: laccato goffrato moka.
 Porta: vetro riflettente fumé con telaio moka opaco.
 Maniglia: moka opaco.

Complementi

Sgabello Sophie Lite: struttura in olmo nero, poggiatesta in brown nickel opaco, rivestimento in pelle sfoderabile Nabuk 08 prussia.

Island d 50 1/2"

Strutture: grey perla melamine.
 Doors and pull-out storage baskets: scotch brite steel.
 Handles: Shape integrated, mat lacquer moka. Sides: Barazza scotch brite steel, thickness 1/4".
 Top: Barazza scotch brite steel, thickness 1/4", with aluminium support frame.
 Mat marble noir saint laurent thickness 1 1/2", with drip edge.
 Plinths: embossed lacquer moka.

Tape snack

Top and sides in solid wood stained black elm.

High tall units d 25 1/4"

Strutture: grey lavagna melamine.
 Doors and pull-out storage baskets: embossed lacquer roccia. Handles: Shape integrated, mat lacquer moka.

Deep Shaker Wall d 6 1/4"

Strutture: anodizzato moka.
 Backs: black elm.
 Bars: embossed lacquer moka.

Tall units d 25 1/4"

Strutture: grey lavagna melamine.
 Doors and pull-out storage baskets: embossed lacquer roccia. Handles: Shape integrated, mat lacquer moka.

Pivot Plus glass door

Portal and frame: embossed lacquer moka.
 Door: fumé reflective glass with mat moka frame.
 Handle: mat moka.

Accessories

Sophie Lite stool: structure in black elm, footrest in mat brown nickel, covering in removable leather Nabuk 08 prussia.

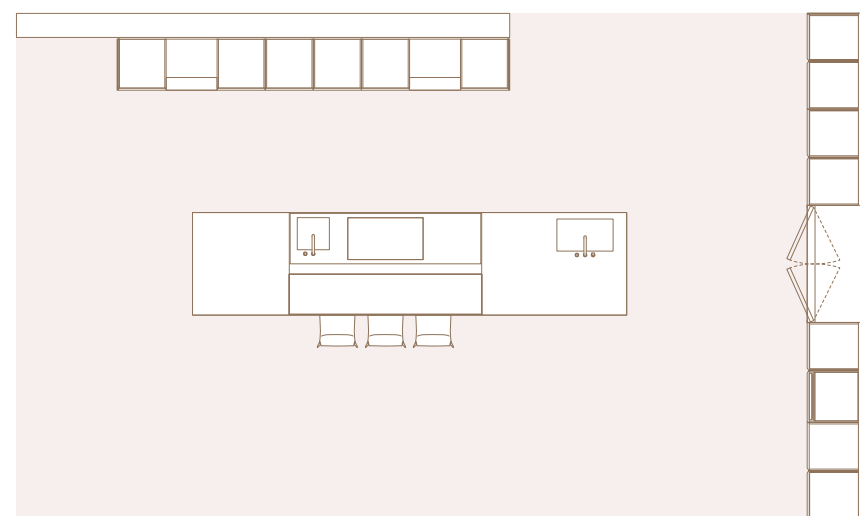
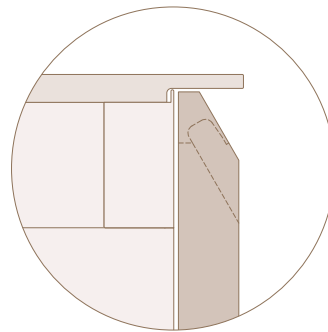

Isola Island

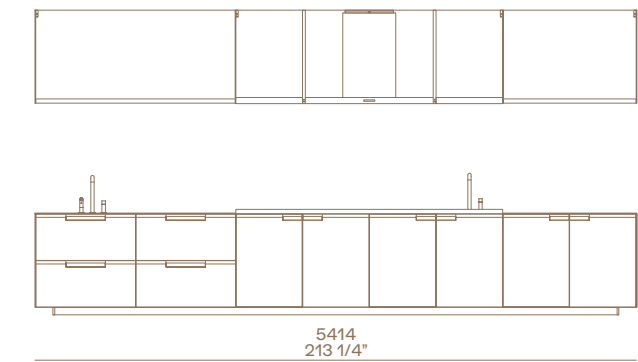
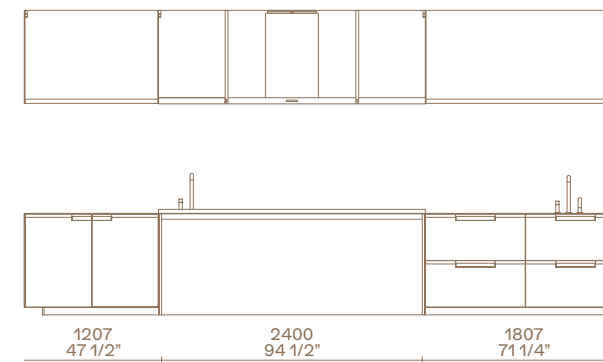

916
36"

Colonne High e Deep Shaker Wall High tall units and Deep Shaker Wall

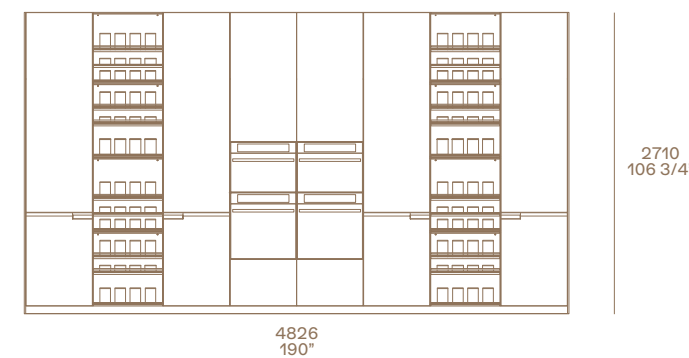

Colonne e porta Pivot Plus vetro Tall units and Pivot Plus glass door

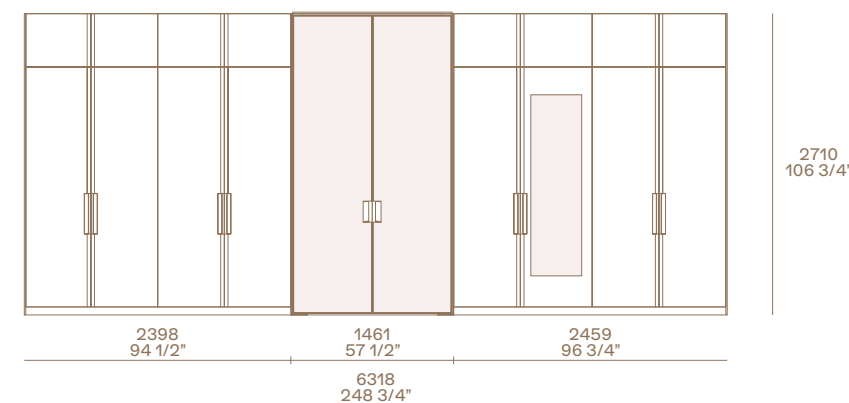

Sophie Lite Design Emmanuel Gallina

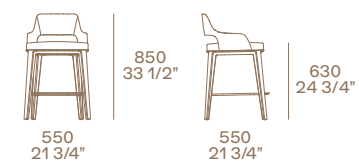

- 1 Colonne con forni, ante ad apertura battente ed estrattori. Maniglia integrata Shape orizzontale.
- 2 Sistema Deep Shaker Wall, a tutta altezza, inserito tra le colonne.
- 3 Basi con ante ed estrattori.
- 4 Attrezzatura interna in alluminio anodizzato naturale.

- 5 Lavello integrato in acciaio scotch brite.
- 6 Lavello integrato in marmo noir saint laurent levigato.
- 7 Piano cottura a induzione, incasso filotop.
- 8 Gocciolatoio in PaperStone® nero.
- 9 Cappa Sail a isola in acciaio verniciato nero opaco, personalizzata Poliform.

- 10 Piano snack 512 x 2400 mm.
- 11 Colonne con frigo e congelatore, maniglia integrata Shape verticale.
- 12 Colonna attrezzata con cantina vini a ripiani estraibili.
- 13 Porta Pivot Plus vetro.

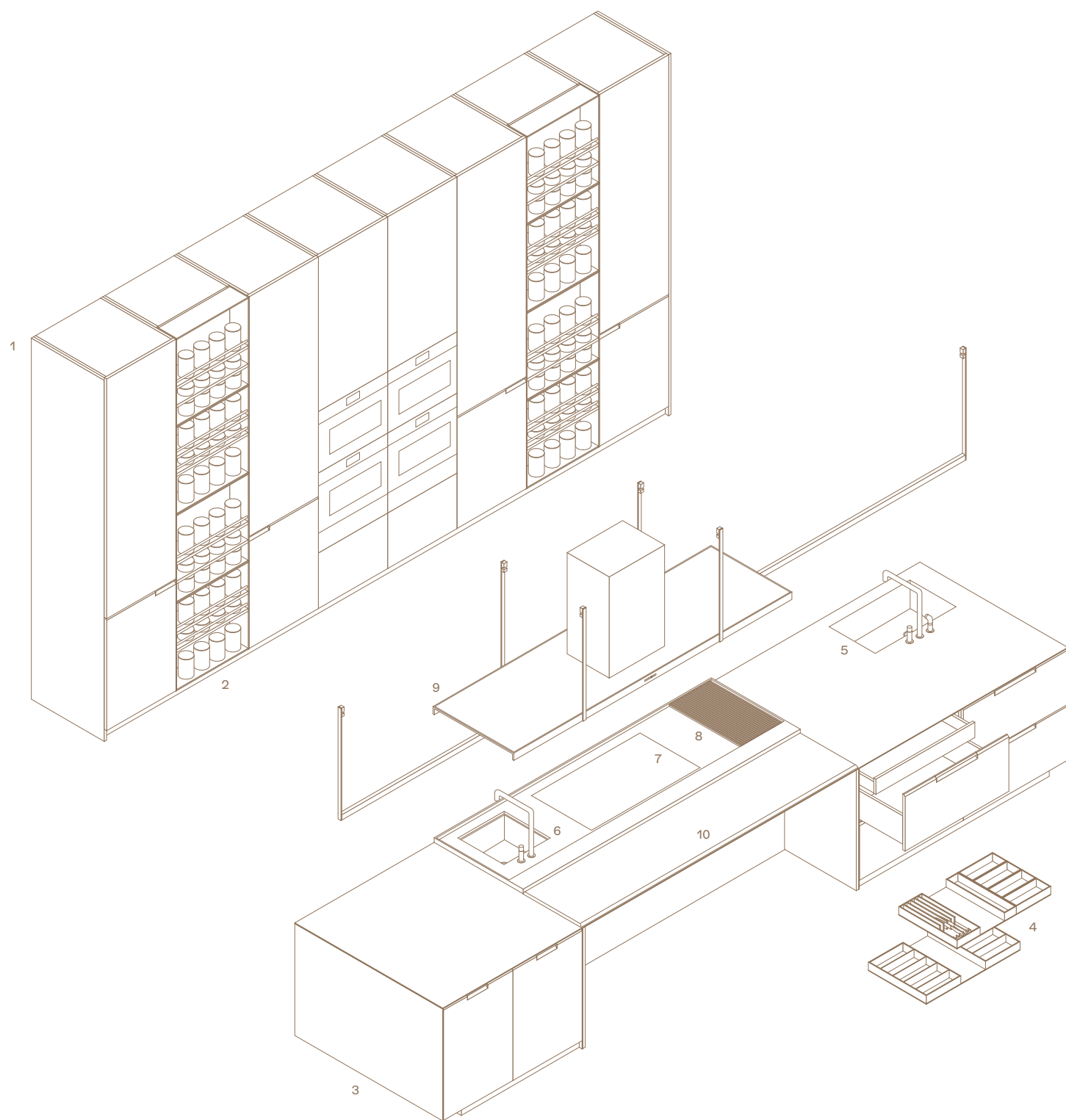

- 1 Tall units with ovens, leaf doors and pull-out storage baskets. Shape horizontal integrated handle.
- 2 System Deep Shaker Wall, full height, inserted between tall units.
- 3 Base units with doors and pull-out storage baskets.
- 4 Inner equipment in anodized natural aluminium.

- 5 Integrated sink in scotch brite steel.
- 6 Integrated sink in mat marble noir saint laurent.
- 7 Induction hob, flush built-in.
- 8 Drip tray in PaperStone® nero.
- 9 Sail island hood in mat black painted steel, personalized Poliform.

- 10 Snack top 20 1/4" x 94 1/2".
- 11 Tall units with fridge and freezer, Shape vertical integrated handle.
- 12 Tall unit equipped with wine cellar and pull-out shelves.
- 13 Pivot Plus glass door.

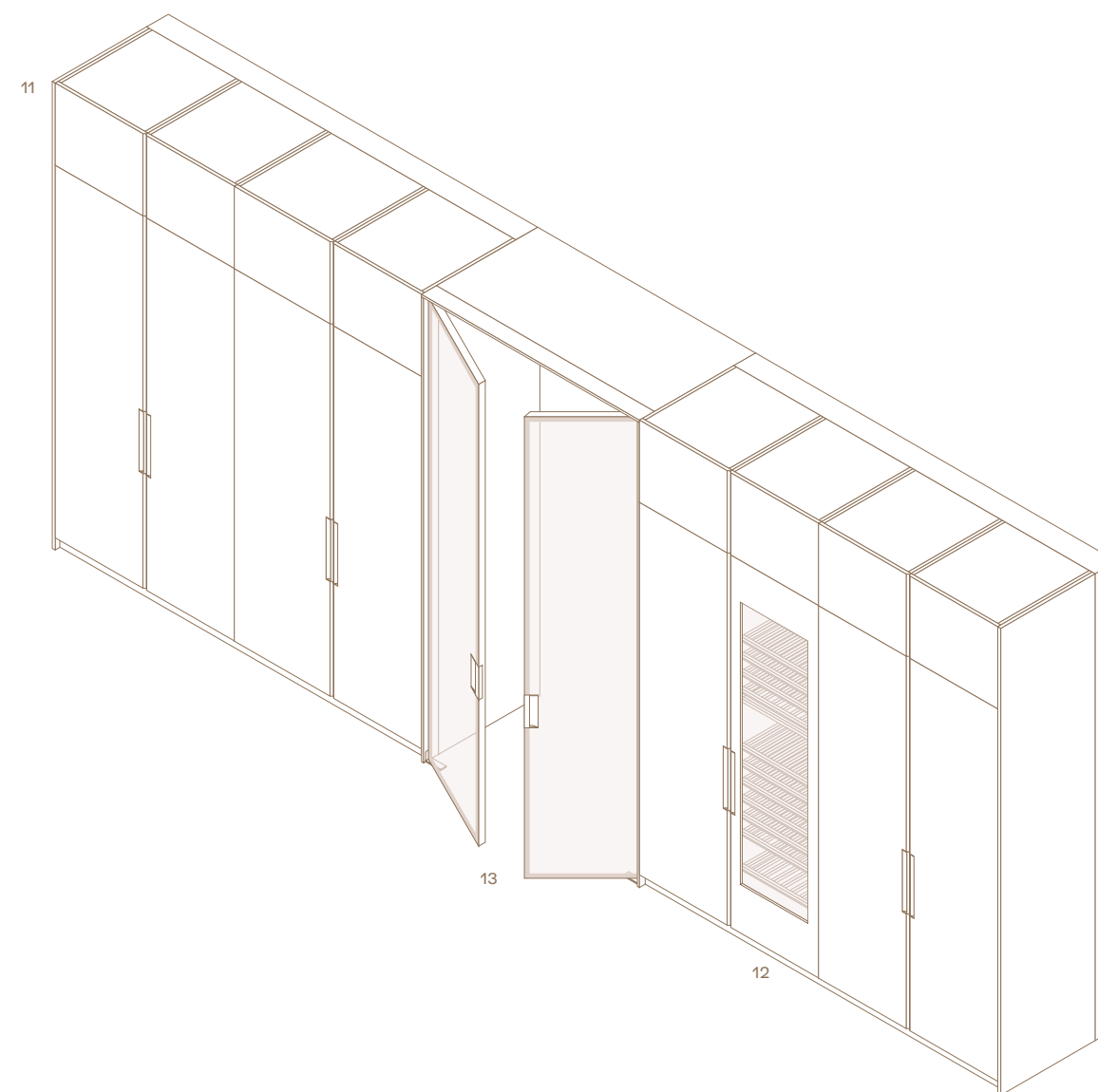

Qui e nelle pagine successive: isola centrale con ante ed estrattori in laccato lucido visone e maniglia integrata Shape in laccato metallico bronzo, piano in Inalco MDi® induction stone brown e fianchi in Inalco MDi® stone brown. Deep Shaker Move in anodizzato moka con piano superiore Inalco MDi® induction stone brown attrezzato con cappa integrata con vetro fumé, piani e cassettini in PaperStone® nero, barattoli in vetro e ceramica con tappo in PaperStone® nero e prese elettriche. Snack Moon in massello rovere fossile con piano centrale girevole integrato in Inalco MDi® stone brown. Sgabelli Ventura in pelle non sfoderabile Silk 12 senape, struttura in olmo nero. Colonne con ante, cassetti ed estrattori in massello rovere fossile, maniglia integrata Shape in laccato opaco moka. Colonne e basi con ante vetrina PR24 in vetro riflettente fumé con telaio in anodizzato moka, top in acciaio scotch brite, fianchi di finitura in massello di noce canaletto termico.

This and next pages: central island with doors and pull-out baskets in visone glossy lacquer and Shape integrated handle in metal lacquer bronzo, top in Inalco MDi® induction stone brown and sides in Inalco MDi® stone brown. Deep Shaker Move in anodized moka with top shelf Inalco MDi® stone brown equipped with integrated hood with fumé glass, shelves and small drawers in PaperStone® nero, glass and ceramic jars with lid in PaperStone® nero and electrical sockets. Moon snack top in solid fossil oak with integrated swivel central top in Inalco MDi® stone brown. Ventura stools in non-removable leather Silk 12 senape, black elm structure. Tall units with doors, drawers and pull-out baskets in solid fossil oak, Shape integrated handle in mat lacquer moka. Tall units and base units with glass doors PR24 in fumé reflective glass with anodized moka frame, top in scotch brite steel, finishing sides in solid thermo treated walnut canaletto.







Deep Shaker Move è un sistema a scomparsa per il piano dell'isola. Può essere attrezzato con ripiani e contenitori, oltre che con la cappa integrata. Il piano superiore è realizzato nella stessa finitura del top della cucina per risultare invisibile. In questa pagina: dettaglio della cappa integrata con vetro fumé, piano in Inalco MDi® induction stone brown.

Deep Shaker Move is a retractable system for the top of the island. It can be equipped with shelves and containers, as well as the integrated hood. The upper surface bears the same finish as the top of the kitchen so as to be invisible. This page: close-up of the integrated hood with fumé glass, top in Inalco MDi® induction stone brown.



A destra: dettaglio del piano cottura a induzione sottotop che, integrato nel piano della cucina, risulta invisibile; piano in Inalco MDi® induction stone brown. Nella pagina precedente: isola centrale con ante ed estrattori in laccato lucido visone e maniglia integrata Shape in laccato metallico bronzo, piano in Inalco MDi® induction stone brown e fianchi in Inalco MDi® stone brown. Deep Shaker Move in anodizzato moka con piano superiore Inalco MDi® induction stone brown, attrezzato con cappa integrata con vetro fumé, tubi in anodizzato moka, piani e cassettini in PaperStone® nero, barattoli in vetro e ceramica con tappo in PaperStone® nero e prese elettriche. Snack Moon in massello rovere fossile con piano centrale girevole integrato in Inalco MDi® stone brown. Sgabelli Ventura in pelle non sfoderabile Silk 12 senape, struttura in olmo nero. Colonne con ante, cassetti ed estrattori in massello rovere fossile, maniglia integrata Shape in laccato opaco moka. Nella pagina successiva: colonne e basi con ante vetrina PR24 in vetro riflettente fumé con telaio in anodizzato moka, ripiani in vetro fumé con telaio in anodizzato nero e cassettiere in olmo nero, illuminazione a led integrata. Top in acciaio scotch brite, fianchi di finitura in massello di noce canaletto termico.

Right: close-up of the under-top-mounted induction hob integrated in the kitchen top, thus invisible; top in Inalco MDi® induction stone brown. Previous page: central island with doors and pull-out baskets in visone glossy lacquer and Shape integrated handle in metal lacquer bronzo, top in Inalco MDi® induction stone brown and sides in Inalco MDi® stone brown. Deep Shaker Move in anodized moka with top shelf in Inalco MDi® induction stone brown, equipped with integrated hood with fumé glass, hanging bars in anodized moka, shelves and small drawers in PaperStone® nero, glass and ceramic jars with lid in PaperStone® nero and electrical sockets. Moon snack top in solid fossil oak with integrated swivel central top in Inalco MDi® stone brown. Ventura stools in non-removable leather Silk 12 senape, black elm structure. Tall units with doors, drawers and pull-out baskets in solid fossil oak, Shape integrated handle in mat lacquer moka. Next page: tall units and base units with glass doors PR24 in fumé reflective glass with anodized moka frame, shelves in glass fumé with black anodized frame and chest of drawers in black elm, integrated led light. Top in scotch brite steel, finishing sides in solid thermo treated walnut canaletto.





SHAPE

Design R&D Poliform

Isola p 1280

Strutture: nobilitato grigio lavagna.
Ante ed estrattori: laccato lucido visone.
Maniglie: integrate Shape, laccato metallico bronzo.
Fianchi: Inalco MDi® stone brown, spessore 6 mm.
Top: Inalco MDi® induction stone brown, spessore 6 mm.
Zoccoli: laccato gofrato moka.

Snack Moon Ø 1800

Struttura e piano: massello rovere fossile.
Piano centrale: girevole integrato, Inalco MDi® stone brown.

Deep Shaker Move p 188

Strutture: anodizzato moka.
Piano superiore: Inalco MDi® induction stone brown.
Cappa integrata: vetro fumé.
Tubi: anodizzato moka.

Colonne p 640

Strutture: nobilitato grigio lavagna.
Ante, cassetti ed estrattori: massello rovere fossile.
Maniglie: integrate Shape, laccato opaco moka.

Colonne e basi vetrina PR24 p 640

Strutture: olmo nero.
Ante: telaio anodizzato moka e vetro riflettente fumé.
Top: acciaio scotch brite, spessore 20 mm.
Fianchi: massello di noce canaletto termico.
Ripiani basi: vetro fumé.
Ripiani colonne: vetro fumé e telaio anodizzato nero.
Cassettiere: massello black ash.

Complementi

Sgabelli Ventura: struttura in olmo nero e rivestimento in pelle Silk 12 senape.

Island d 50 1/2"

Structures: grey lavagna melamine.
Doors and pull-out storage baskets: glossy lacquer visone.
Handles: Shape integrated, metal lacquer bronzo.
Sides: Inalco MDi® stone brown, thickness 1/4".
Top: Inalco MDi® induction stone brown, thickness 1/4".
Plinths: embossed lacquer moka.

Snack Moon Ø 70 3/4"

Structure and top: solid fossil oak.
Central top: integrated swivel top, Inalco MDi® stone brown.

Deep Shaker Move d 7 1/2"

Structures: anodized moka.
Upper shelf: Inalco MDi® induction stone brown.
Integrated hood: fumé glass.
Bars: anodized moka.

Tall units d 25 1/4"

Structures: grey lavagna melamine.
Doors, drawers and pull-out baskets: solid fossil oak.
Handles: Shape integrated, mat lacquer moka.

Tall units and base units wit glass doors PR24 d 25 1/4"

Structures: black elm.
Doors: anodized moka frame and fumé reflective glass.
Top: scotch brite steel, thickness 3/4".
Sides: solid thermo treated walnut canaletto.
Base units shelves: fumé glass.
Tall units shelves: fumé glass and anodized black frame.
Chests of drawers: solid black ash.

Accessories

Ventura stool: structure in black elm and covering in removable leather Silk 12 senape.

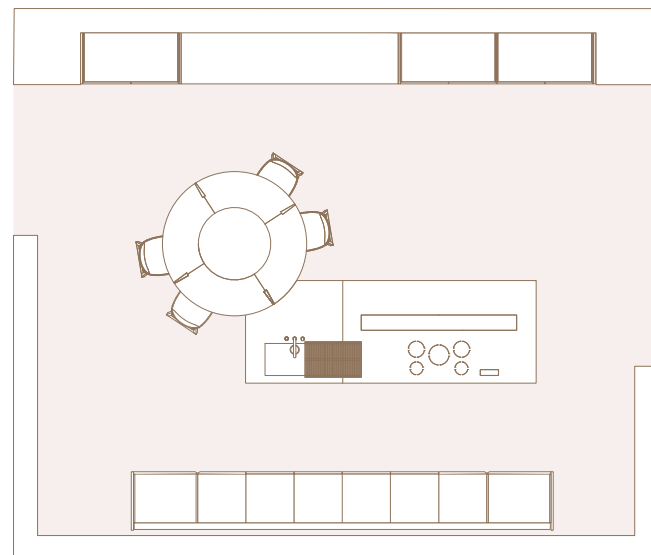
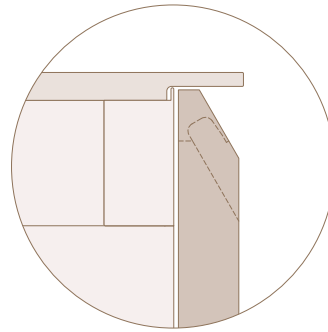

Isola Island

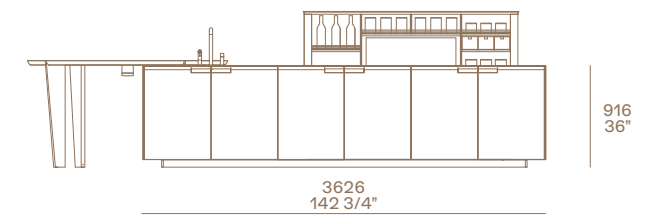
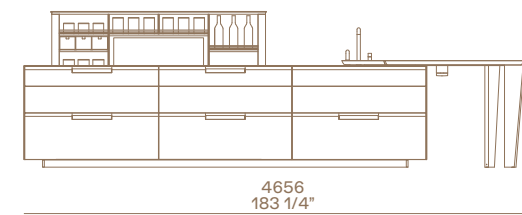

Colonne Tall units

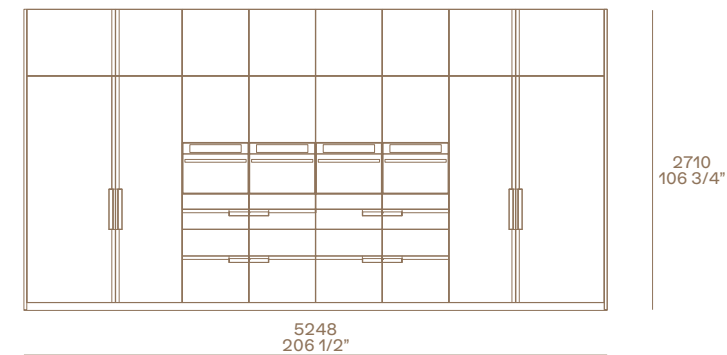

Colonne e basi vetrina PR24 Glass tall units and base units PR24

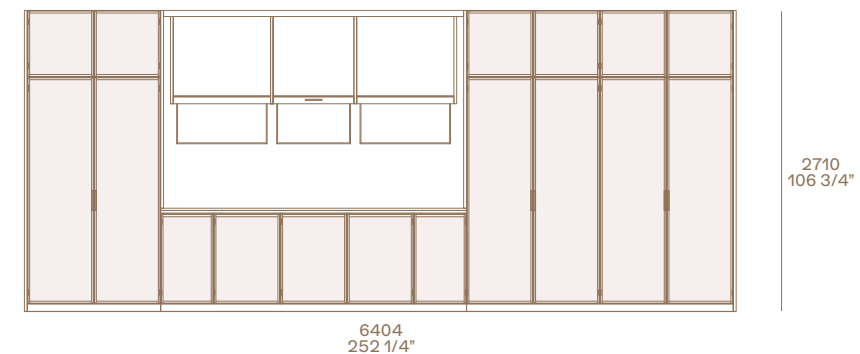

Ventura

Design Jean-Marie Massaud



- 1 Basi con ante ed estrattori.
- 2 Deep Shaker Move attrezzato con cappa integrata e vetro fumé.
- 3 Piano cottura a induzione sottotop con piano in Inalco MDi® induction stone brown.

- 4 Lavello integrato in Inalco MDi® stone brown.
- 5 Gocciolatoio in PaperStone® nero.
- 6 Attrezzature in wengé per cassetti interni ed estrattori.
- 7 Snack Moon, ø 1800 mm.

- 8 Colonne con forno multifunzione compatto, forno multifunzione combinato microonde, forno a vapore, macchina del caffè, scaldastoviglie, cassetto sottovuoto, frigo e congelatore.
- Ante laterali con apertura battente. Al centro, cassetti, estrattori ed ante superiori con apertura tip-on. Elementi sopra colonna con apertura tip-on.

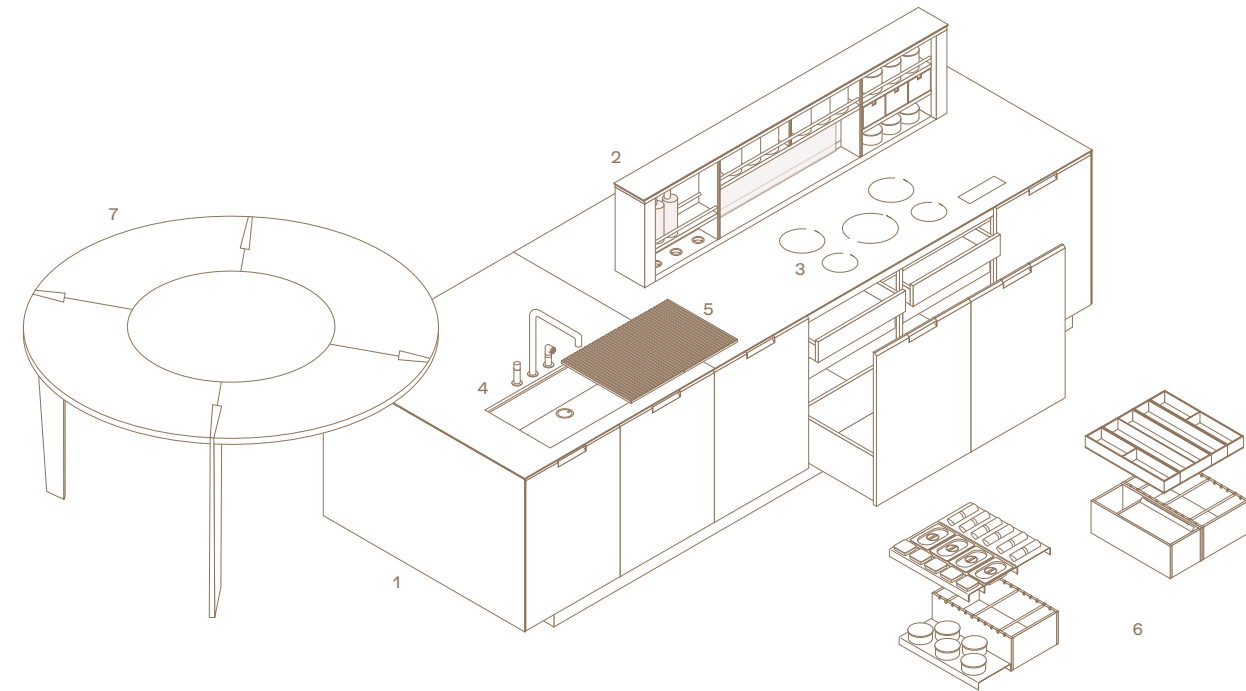

- 1 Base units with doors and pull-out storage baskets.
- 2 Deep Shaker Move equipped with integrated hood and fumé glass.
- 3 Under-top-mounted induction hob with top in Inalco MDi® induction stone brown.

- 4 Integrated sink in Inalco MDi® induction stone brown.
- 5 Drip tray in PaperStone® nero.
- 6 Equipment for inner drawers and pull-out storage baskets in wengé.
- 7 Snack Moon, ø 70 3/4".

- 8 Tall units with compact multifunction oven, combined microwave multifunction oven, steam oven, coffee machine, dish warmer, vacuum drawer, fridge and freezer. Lateral doors with leaf opening. In the center, drawers, pull-out baskets and upper doors with tip-on opening. Cabinets above tall units with tip-on opening.

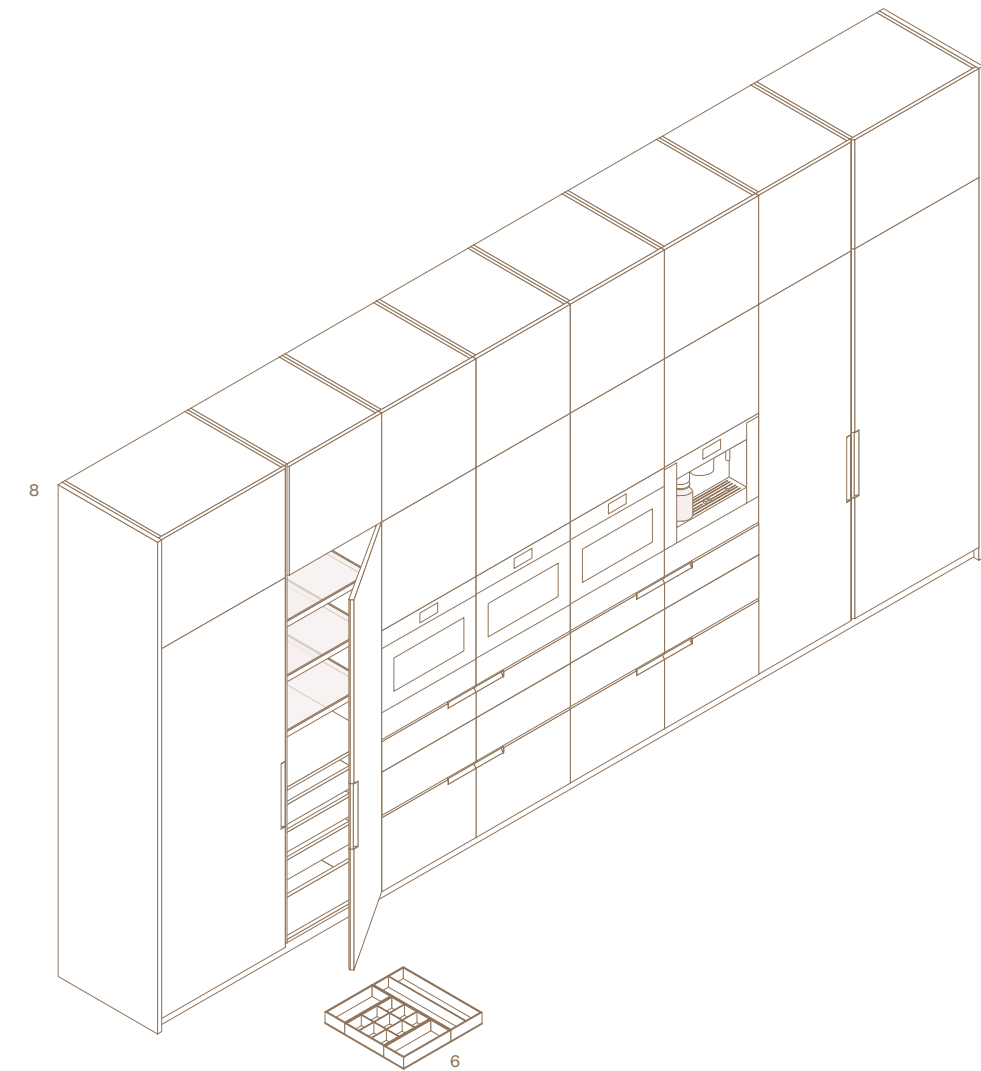

ARTEX

Per la lavorazione sartoriale che ne contraddistingue l'anta, spesso abbinata a finiture preziose o nella versione a doghe, la cucina Artex è pensata per gli ambienti più esclusivi. Il progetto, firmato Poliform, è caratterizzato dalla particolare rastrematura eseguita sull'apertura, sul fianco e sul top, così da ottenere un incastro perfetto.

For the sartorial look that marks the door, often combined with precious finishes or in the slatted version, the Artex kitchen is designed for the most exclusive environments. The project, signed Poliform, is characterised by the particular tapering performed on the opening, on the side, and on the top, so as to obtain a perfect joint.





Qui, nelle pagine precedenti e nelle successive: isola con ante ed estrattori in massello noce canaletto, top in marmo calacatta oro levigato. Cappa Factory a isola in acciaio scotch brite. Piano snack Blade in massello noce canaletto. Sgabelli Ventura in olmo nero con seduta rivestita in tessuto non sfoderabile Kitami 04 sabbia. Pensili e basi a parete con ante, cassetti ed estrattori in laccato metallico ottone, top in marmo calacatta oro levigato. Schienali modulari Deep Shaker con moduli sopratop e a terra in alluminio anodizzato moka e schienali in laccato goffrato moka, mensola superiore in laccato goffrato moka e luce a led integrata. Colonne con ante vetrina PR21 con telaio anodizzato moka e vetro riflettente fumé, luce a led integrata. Colonne con ante ed estrattori in laccato metallico ottone.

This, previous and next pages: island units with doors and pull-out baskets in solid walnut canaletto, worktop in mat marble calacatta oro. Factory island hood in steel scotch brite. Blade snack top in solid walnut canaletto. Ventura stools in black elm with seat covered in non-removable fabric Kitami 04 sabbia. Wall units and wall base units with doors, drawers and pull-out baskets in metal lacquer ottone, worktop in mat marble calacatta oro. Deep Shaker modular backs with above-top units and floor standing units in moka anodized aluminium and backs in embossed lacquer moka, upper shelf in embossed lacquer moka and integrated led light. Tall units with glass doors PR21 with anodized moka frame and fumé reflective glass, integrated led light. Tall units with doors and pull out baskets in metal lacquer ottone.





A sinistra: dettaglio dell'estrattore in massello noce canaletto con cassetto interno e attrezzatura in alluminio anodizzato naturale.

Left: close-up of the pull-out basket in solid walnut canaletto with interior drawer and accessories in natural anodized aluminium.



A destra: dettaglio di Deep Shaker in anodizzato moka, schienali in laccato gofrato moka, tubi in acciaio scotch brite, cassettini in noce canaletto e barattoli in ceramica.

Right: close-up of Deep Shaker in anodized moka, backs in embossed lacquer moka, bars in scotch brite steel, small drawers in walnut canaletto and ceramic jars.





A sinistra: isola con ante ed estrattori in massello noce canaletto, top in marmo calacatta oro levigato. Pensili e basi a parete con ante ed estrattori in laccato metallico ottone, top in marmo calacatta oro levigato. Schienali modulari Deep Shaker con moduli sopratop in alluminio anodizzato moka, schienali in laccato goffrato moka e tubi in acciaio scotch brite. Colonne con ante vetrina PR21 con telaio anodizzato moka e vetro riflettente fumé, luce a led integrata.

Left: island with doors and pull-out baskets in solid walnut canaletto, worktop in mat marble calacatta oro. Wall units and wall base units with doors and pull-out baskets in metal lacquer ottone, worktop in mat marble calacatta oro. Deep Shaker modular back panels with above-top units in moka anodized aluminium, backs in embossed lacquer moka and bars in scotch brite steel. Tall units with glass doors PR21 with anodized moka frame and fumé reflective glass, integrated led light.



Qui e nelle pagine precedenti: isola con ante ed estrattori in massello noce canaletto, top in marmo calacatta oro levigato. Cappa Factory a isola in acciaio scotch brite. Piano snack Blade in massello noce canaletto. Sgabelli Ventura in olmo nero con seduta rivestita in tessuto non sfoderabile Kitami 04 sabbia. Pensili e basi a parete con ante, cassetti ed estrattori in laccato metallico ottone, top in marmo calacatta oro levigato. Schienali modulari Deep Shaker con moduli sopratop e a terra in alluminio anodizzato moka e schienali in laccato goffrato moka, mensola superiore in laccato goffrato moka e luce a led integrata. Colonne con ante vetrina PR21 con telaio anodizzato moka e vetro riflettente fumé, luce a led integrata.

This and previous pages: island units with doors and pull-out baskets in solid walnut canaletto, worktop in mat marble calacatta oro. Factory island hood in steel scotch brite. Blade snack top in solid walnut canaletto. Ventura stools in black elm with seat covered in non-removable fabric Kitami 04 sabbia. Wall units and wall base units with doors, drawers and pull-out baskets in metal lacquer ottone, worktop in mat marble calacatta oro. Deep Shaker modular backs with above-top units and floor standing units in moka anodized aluminium and backs in embossed lacquer moka, upper shelf in embossed lacquer moka and integrated led light. Tall units with glass doors PR21 with anodized moka frame and fumé reflective glass, integrated led light.





A sinistra: dettaglio della caratteristica rastrematura della cucina Artex eseguita su anta, fianco e top per assicurare un incastro perfetto.

Left: close-up of the distinguishing tapered edge of the kitchen Artex for door, side and worktop to ensure a perfect joint.

ARTEX

Design R&D Poliform

Isola p 1280

Strutture: nobilitato grigio perla.
Ante ed estrattori: massello noce canaletto.
Fianchi: massello noce canaletto, spessore 26 mm.
Top: marmo calacatta oro levigato, spessore 20 mm con bordo rastremato.
Zoccoli: laccato goffrato moka.

Snack Blade

Massello noce canaletto.

Basi a parete p 740 e 840, pensili p 410

Strutture: nobilitato grigio perla.
Ante, cassetti ed estrattori: laccato metallico ottone.
Fianchi: laccato metallico ottone, spessore 26 mm.
Top: marmo calacatta oro levigato, spessore 20 mm con bordo rastremato.

Deep Shaker p 160

Strutture: anodizzato moka.
Schienali: laccato goffrato moka.
Mensola superiore: laccato goffrato moka.
Tubi: acciaio scotch brite.

Colonne vetrina PR21 p 640

Struttura: noce canaletto naturale.
Ante: telaio anodizzato moka e vetro riflettente fumé.
Ripiani: vetro fumé e telaio anodizzato nero.
Cassettiere: laminato opaco touch nero.

Colonne p 640

Strutture: nobilitato grigio perla.
Ante ed estrattori: laccato metallico ottone.

Complementi

Sgabello Ventura: struttura in olmo nero e rivestimento in tessuto Kitami 04 sabbia.

Island d 50 1/2"

Structures: grey perla melamine.
Doors and pull-out storage baskets: solid walnut canaletto.
Sides: solid walnut canaletto, thickness 1".
Top: mat marble calacatta oro, thickness 3/4" with tapered edge.
Plinths: embossed lacquer moka.

Blade snack

Solid walnut canaletto.

Wall base units d 29 1/4" and 33", wall units d 16 1/4"

Structures: grey perla melamine.
Doors, drawer and pull-out storage baskets: metal lacquer ottone.
Sides: metal lacquer ottone, thickness 1".
Top: mat marble calacatta oro, thickness 3/4" with tapered edge.

Deep Shaker d 6 1/4"

Structures: anodized moka.
Back: embossed lacquer moka.
Upper shelf: embossed lacquer moka.
Bars: scotch brite steel.

Tall units with glass doors PR21 d 25 1/4"

Structure: natural walnut canaletto.
Doors: anodized moka frame and fumé reflective glass. Shelves: fumé glass and black anodized frame.
Chests of drawers: mat laminate touch nero.

Tall units d 25 1/4"

Structures: grey perla melamine. Doors, pull-out storage baskets: metal lacquer ottone.

Accessories

Ventura stool: structure in black elm and cover in fabric Kitami 04 sabbia.

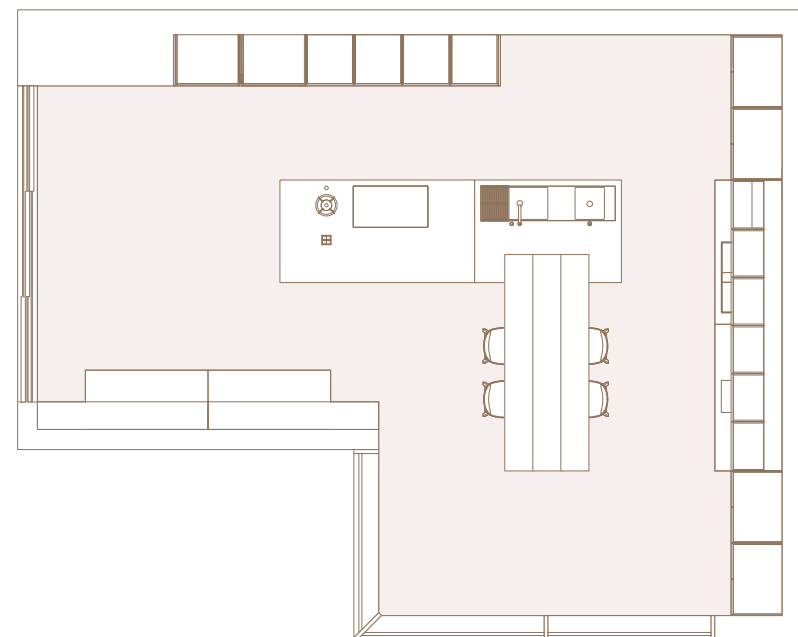
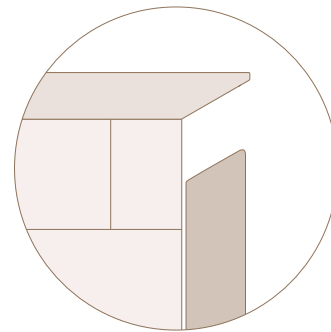

Isola Island

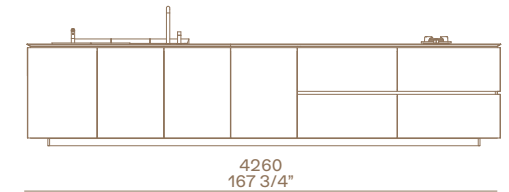
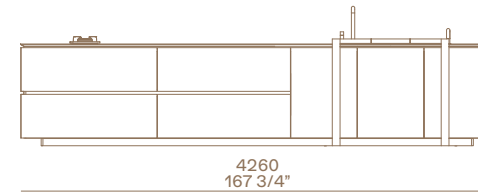
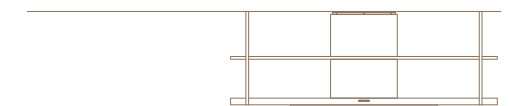
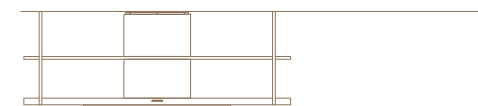

917
36 1/8"

Basi a parete, pensili, Deep Shaker, colonne vetrina PR21 Wall base units, wall units, Deep Shaker, glass tall units PR21

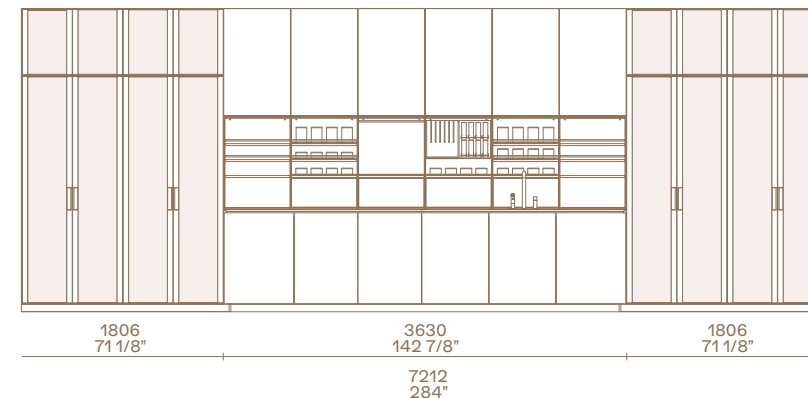

960
37 3/4"

833
32 3/4"

2710
106 3/4"

917
36 1/8"

1806
71 1/8"

3630
142 7/8"

1806
71 1/8"

7212
284"

Colonne Tall units

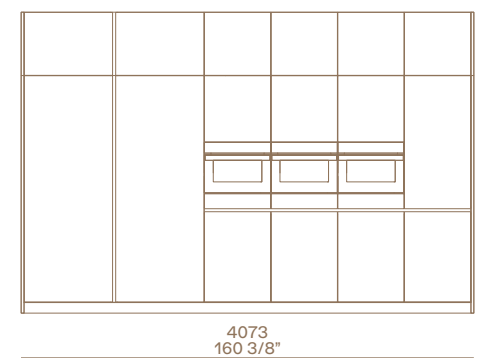

2710
106 3/4"

4073
160 3/8"

Basi a parete, Deep Shaker Wall base units, Deep Shaker

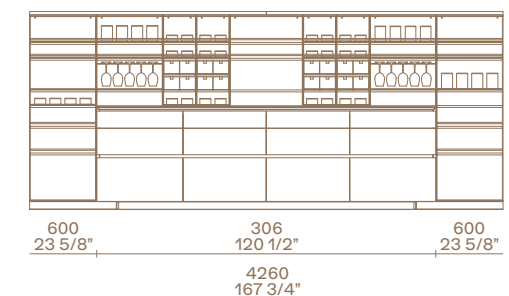

30
1 1/4"

833
32 3/4"

1780
70"

917
36 1/8"

600
23 5/8"

306
120 1/2"

600
23 5/8"

4260
167 3/4"

Ventura

Design Jean-Marie Massaud



485
19"

500
19 3/4"

- 1 Colonne con forno multifunzione compatto, forno multifunzione combinato microonde, forno a vapore, scaldastoviglie, cassetto sottovuoto, frigo, congelatore, ante ed estrattori. Ante ed elementi sopra colonna con apertura tip-on.
- 2 Basi isola con ante ed estrattori.
- 3 Piano cottura a gas Pitt Cooking® con manopola personalizzata Poliform.
- 4 Presa elettrica a scomparsa.
- 5 Piano cottura a induzione, incasso filotop.

- 6 Attrezzature in alluminio anodizzato naturale per cassetti interni ed estrattori.
- 7 Cappa Factory a isola in acciaio scotch brite, personalizzata Poliform.
- 8 Lavelli in acciaio scotch brite, incasso sottotop.
- 9 Gocciolatoio in PaperStone® nero.
- 10 Snack Blade 2700 x 1050 mm.
- 11 Colonne con ante vetrina PR21, cassettiere in laminato opaco touch nero, ripiani in vetro fumé con telaio in anodizzato nero.

- 12 Basi a parete con ante, cassetti ed estrattori.
- 13 Pensili con ante battenti, apertura tip-on.
- 14 Schienale modulare Deep Shaker con moduli sopratop e a terra.
- 15 Piano cottura Miele SmartLine a induzione con piastra Teppan Yaki in acciaio, incasso filotop.
- 16 Lavello in acciaio scotch brite, incasso sottotop.
- 17 Mensola superiore laccata con luce a led integrata.

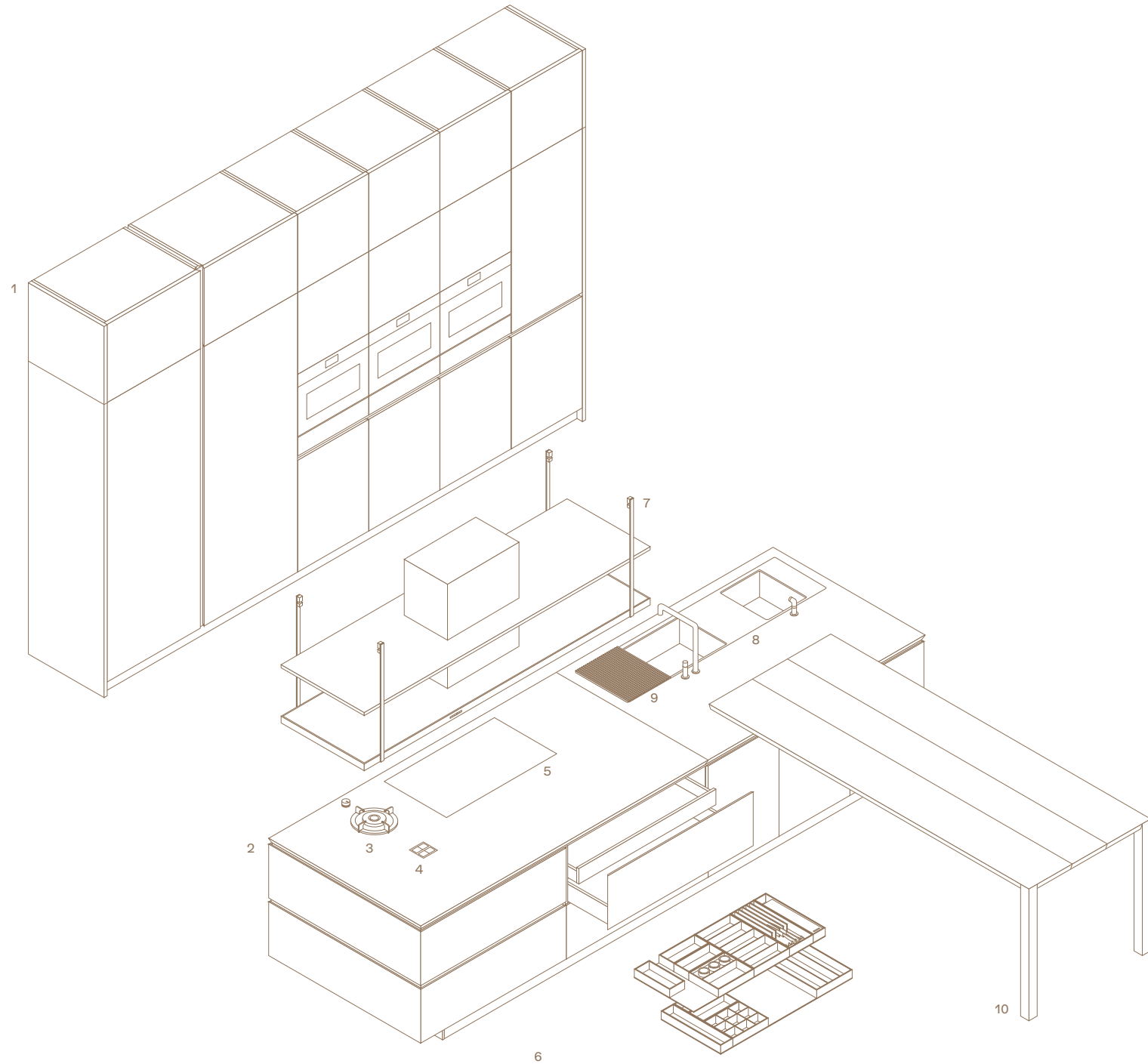

- 1 Tall units with compact multifunction oven, combined microwave multifunction oven, steam oven, dish warmer, vacuum drawer, fridge, freezer doors and pull-out storage baskets. Doors and cabinets above tall units with tip-on opening.
- 2 Island base units with doors and pull-out storage baskets.
- 3 Gas hob Pitt Cooking® with personalized Poliform knob.
- 4 Concealed electrical socket.
- 5 Induction hob, flush built-in.

- 6 Equipment in anodized natural aluminium for inner drawers and pull-out storage baskets.
- 7 Factory island hood in scotch brite steel, personalized Poliform.
- 8 Sinks in scotch brite steel, under-top built-in.
- 9 Drip tray in PaperStone® nero.
- 10 Blade snack 106 1/4" x 41 1/4".
- 11 Tall units with glass doors PR21, chests of drawers in mat laminate touch nero, shelves in fumé glass with black anodized frame.

- 12 Wall base units with doors, drawers and pull-out storage baskets.
- 13 Wall units with leaf doors, tip-on opening.
- 14 Deep Shaker modular back panel with above-top and floorstanding units.
- 15 Miele SmartLine induction hob with Teppan Yaki plate in steel, flush built-in.
- 16 Sink in scotch brite steel, under-top built-in.
- 17 Lacquered upper shelf with integrated led light.

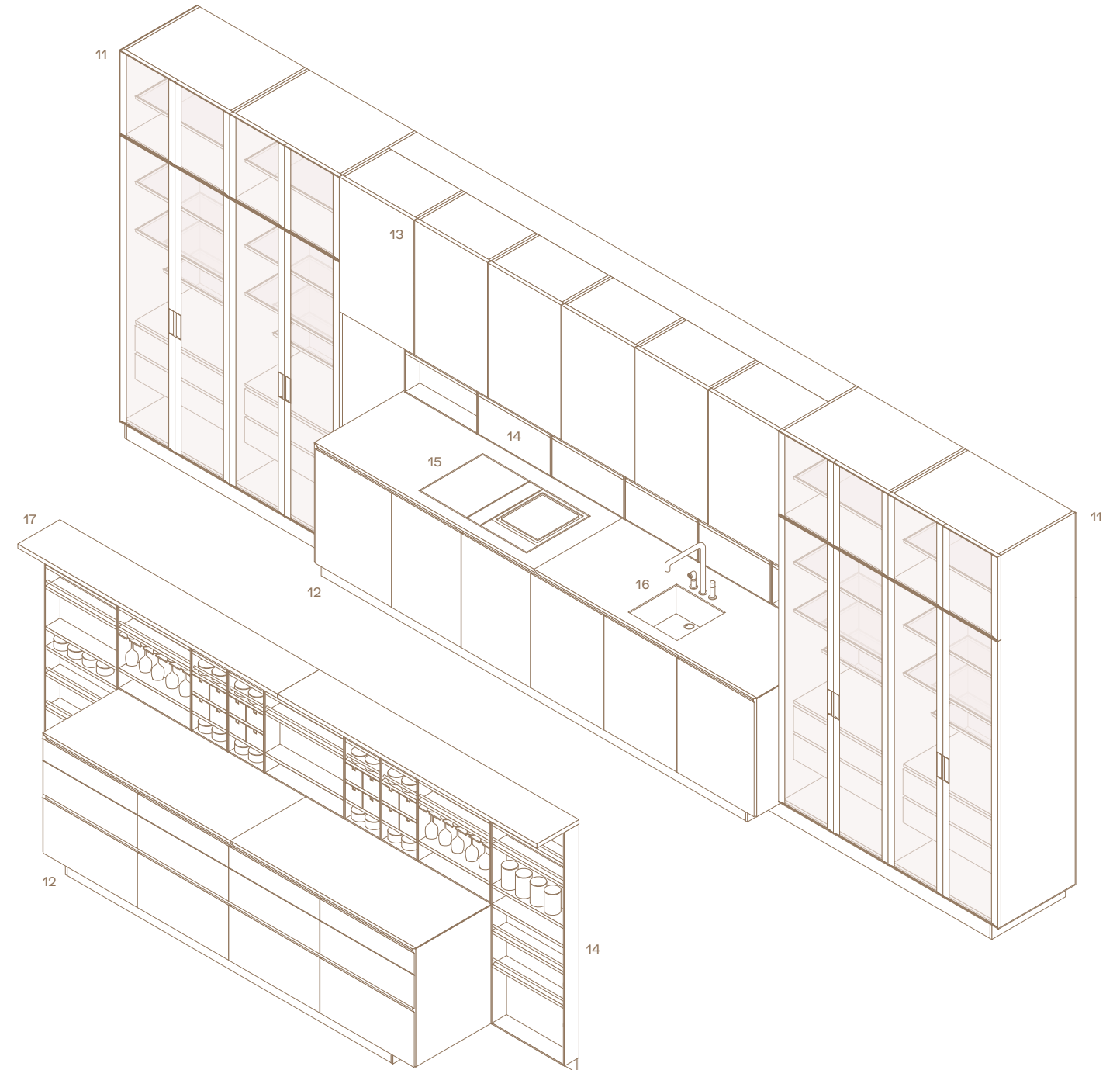

Qui e nella pagina successiva: basi con ante ed estrattori in acciaio scotch brite, top in pietra fossena fiammata. Cappa Factory a isola in acciaio scotch brite. Colonne centrali con ante in laccato goffrato visone, colonne ed elementi sopra colonna con ante vetrina PR21, telaio anodizzato moka e vetro riflettente fumé. Boiserie con pannelli in olmo nero e mensole in laccato goffrato carbone.

This and next page: base units with doors and pull-out storage baskets in scotch brite steel, top in fossena stone blaze. Factory island-hood in scotch brite steel. Central tall units with embossed lacquered visone doors, tall units and cabinets above tall units PR21 with anodized moka frame and fumé reflective glass doors. Black elm wall panelling and embossed lacquered carbone shelves.







A sinistra: dettaglio dell'estrattore con cassetti verniciato brown, piattaja e attrezzatura interna in noce canaletto e alluminio anodizzato moka.

Left: close-up of pull-out storage basket with drawers painted brown, plate holder and inner drawer equipment in walnut canaletto and moka anodized aluminium.



Qui e nella pagina precedente: basi con ante ed estrattori in acciaio scotch brite, top in pietra fossena fiammata. Cappa Factory a isola in acciaio scotch brite. Colonne centrali con ante in laccato goffrato visone, colonne ed elementi sopra colonna con ante vetrina PR21, telaio anodizzato moka e vetro riflettente fumé. Boiserie con pannelli in olmo nero e mensole in laccato goffrato carbone.

This and previous page: base units with doors and pull-out storage baskets in scotch brite steel and top in fossena stone blaze. Factory island-hood in scotch brite steel. Central tall units with embossed lacquered visone doors, tall units and cabinets above tall unit PR21 with anodized moka frame and fumé reflective glass doors. Black elm wall panelling and embossed lacquered carbone shelves.





A sinistra: dettaglio del piano in pietra fossena fiammata con bordo rastremato e telaio di supporto in alluminio con finitura laccato goffrato carbone.

Left: close-up of top in fossena stone blaze with tapered edge and supporting frame in aluminium with embossed lacquered carbone finishing.



Nella pagina precedente: basi con ante ed estrattori in acciaio scotch brite e top in pietra fossena fiammata. Cappa Factory a isola in acciaio scotch brite. Colonne centrali con ante in laccato goffrato visone, colonne ed elementi sopra colonna con ante vetrina PR21, telaio anodizzato moka e vetro riflettente fumé. A destra: ante vetrina PR21 con telaio anodizzato moka e vetro riflettente fumé; negli elementi sopra colonna ante ad apertura tip-on.

Previous page: base units with doors and pull-out storage baskets in scotch brite steel and top in fossena stone blaze. Factory island-hood in scotch brite steel. Central tall units with embossed lacquered visone doors, tall units and cabinets above tall unit PR21 with anodized moka frame and fumé reflective glass doors. Right: glass tall units PR21 with doors in fumé reflective glass and anodized moka frame; in the elements above tall unit doors with tip-on opening.





A sinistra: dettaglio dell'anta vetrina PR21 in anodizzato moka e vetro riflettente fumé con maniglia integrata nel montante del telaio. Ripiani interni in vetro fumé con telaio anodizzato nero e cassetiera in olmo nero con gola laccato opaco moka.

Left: close-up of the glass door PR21 in anodized moka and fumé reflective glass with handle integrated in the frame upright. Fumé glass inner shelves with black anodized frame and chest of drawers in black elm with channel in moka mat lacquer.

A destra: dettaglio delle colonne con ante vetrina PR21, telaio anodizzato moka e vetro riflettente fumé. Ripiani interni in vetro fumé con telaio anodizzato nero e cassettiere in olmo nero con gola laccato opaco moka.

Right: close-up of tall units with doors PR21 with anodized moka frame and fumé reflective glass doors. Fumé glass inner shelves with black anodized frame and chest of drawers in black elm with channel in moka mat lacquer.





A sinistra: dettaglio della cassettera con attrezzatura in noce canaletto e alluminio anodizzato moka.

Left: close-up of inner chest of drawers with equipment in walnut canaletto and moka anodized aluminium.



Qui e nella pagina precedente: basi con ante ed estrattori in olmo nero a doghe e top in pietra fossena fiammata. Piano cottura in acciaio scotch brite a cinque fuochi e lavello in acciaio scotch brite personalizzati Poliform by Barazza. Cappa Factory a isola in acciaio scotch brite.

This and previous page: base units with doors and pull-out storage baskets in black elm with carved lines and top in fossena stone blaze. Personalized five burners scotch brite steel hob and sink Poliform by Barazza. Factory island-hood in scotch brite steel.



ARTEX

Design R&D Poliform

Basi p 1280

Strutture: nobilitato grigio lavagna.
Ante, estrattori e fianchi: acciaio scotch brite.
Top: pietra fossena fiammata spessore 20 mm con bordo rastremato e telaio di supporto in alluminio laccato goffrato carbone.
Zoccoli: laccato goffrato carbone.

Colonne vetrina PR21 p 640

Strutture: nobilitato grigio lavagna.
Ante: telaio anodizzato moka e vetro riflettente fumé.
Ripiani interni: vetro fumé e telaio anodizzato nero.
Cassettiere interne: olmo nero con gola laccato opaco moka.

Colonne parte centrale

Ante e gole orizzontali: laccato goffrato visone.

Elementi sopra colonna vetrina PR21

Ante: telaio anodizzato moka e vetro riflettente fumé.
Aperture: tip-on.
Ripiani interni: vetro fumé con telaio anodizzato nero.

Boiserie

Pannelli: olmo nero.
Mensole: laccato goffrato carbone, spessore 3 mm.

Base units d 50 1/2"

Structures: grey lavagna melamine.
Doors, pull-out storage baskets and sides: scotch brite steel.
Top: fossena stone blaze, thickness 3/4" with tapered edge and supporting frame in carbone embossed lacquered aluminium.
Plinths: embossed lacquer carbone.

Glass tall units PR21 d 25 1/4"

Structures: grey lavagna melamine.
Doors: anodized moka frame and fumé reflective glass.
Inner shelves: fumé glass with black anodized frame.
Inner chest of drawers: black elm with channel moka mat lacquer.

Central tall units

Doors and horizontal channels: embossed lacquer visone.

Cabinets above tall unit PR21

Doors: anodized moka frame and fumé reflective glass.
Openings: tip-on.
Inner shelves: fumé glass with black anodized frame.

Wall panelling

Panels: black elm.
Shelves: embossed lacquer carbone, thickness 1/8".

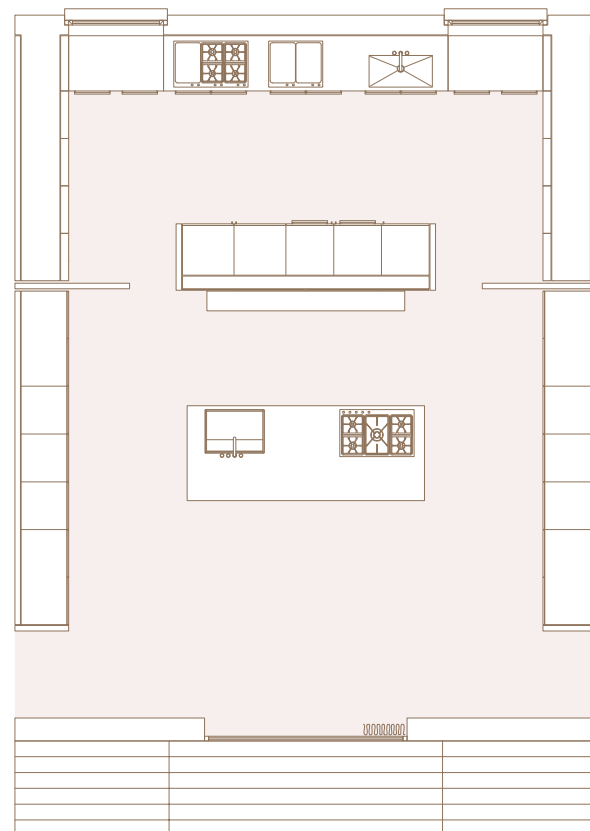
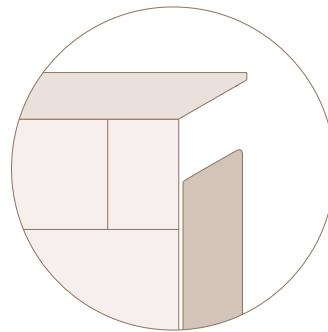

Basi Base units

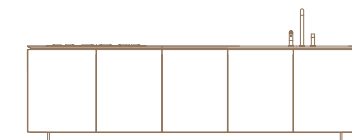
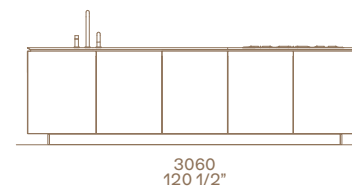

Boiserie Wall panelling

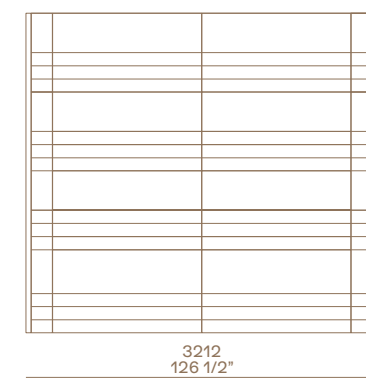

Colonne Tall units

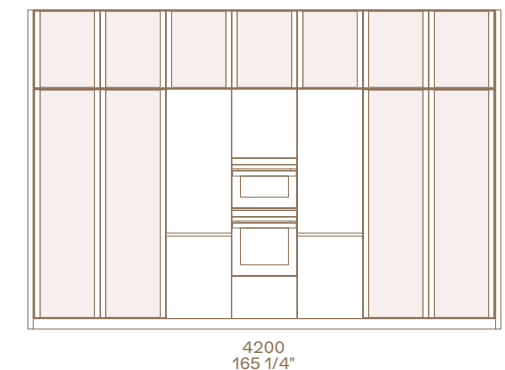
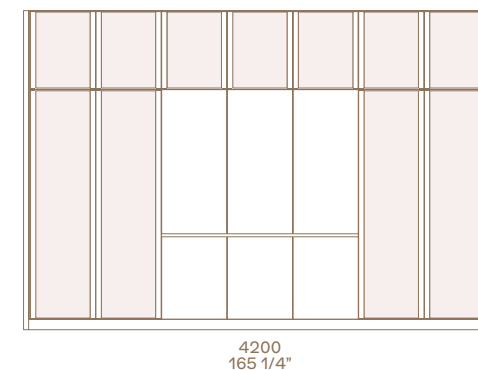

- 1 Piano cottura in acciaio scotch brite
5 fuochi personalizzato Poliform by
Barazza, incasso filotop.
- 2 Lavello in acciaio scotch brite
personalizzato Poliform by Barazza con
sportello copripiletta, incasso filotop.
- 3 Attrezzatura in noce canaletto e
alluminio anodizzato moka per cassetti
interni ed estrattori.

- 4 Cappa Factory a isola in acciaio scotch
brite.
- 5 Boiserie con pannelli in olmo nero.
- 6 Elementi sopra colonna vetrina PR21,
ante apertura tip-on.
- 7 Colonne vetrina PR21 con ante ad
apertura battente, ripiani interni e
cassettiere.

- 8 Colonne centrali con forni e frigo/
congelatore, con ante ad apertura
battente ed estrattori.
- 9 Attrezzatura in noce canaletto e
alluminio anodizzato moka per
cassettiera interna.

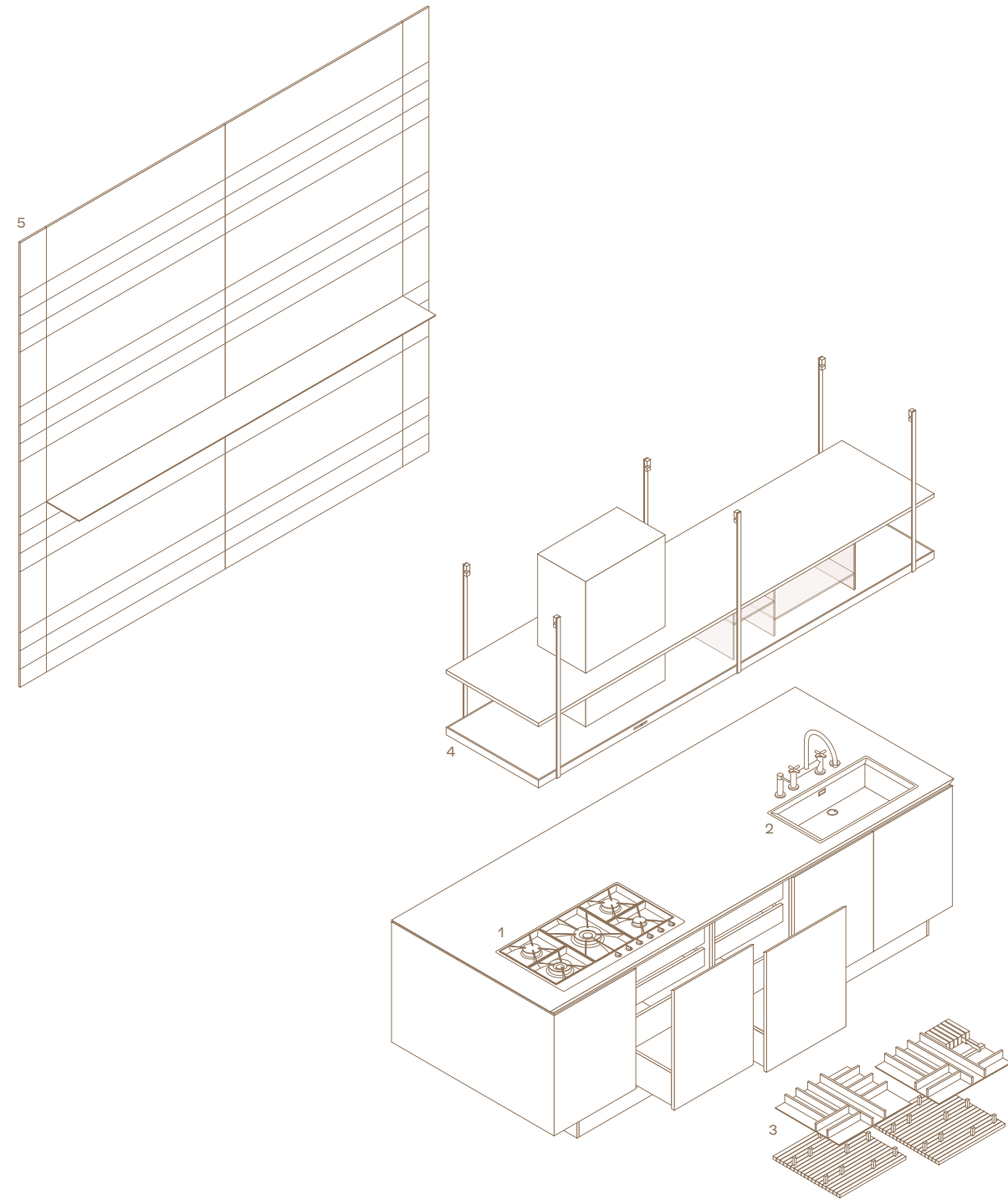

- 1 Personalized scotch brite steel hob with
5 burners Poliform by Barazza, fully flush
built-in.
- 2 Personalized scotch brite steel sink
Poliform by Barazza with drain cover,
fully flush built-in.
- 3 Equipment in walnut canaletto and moka
anodized aluminium for inner drawers
and pull-out storage baskets.

- 4 Factory island-hood in scotch brite
steel.
- 5 Wall panelling in black elm.
- 6 Elements above tall unit PR21, glass
doors with tip-on opening.
- 7 Glass tall units PR21 with leaf doors,
inner shelves and chest of drawers.

- 8 Central tall units with ovens, fridge and
freezer with leaf doors and pull-out
storage baskets.
- 9 Equipment in walnut canaletto and
moka anodized aluminium for inner
chest of drawers.

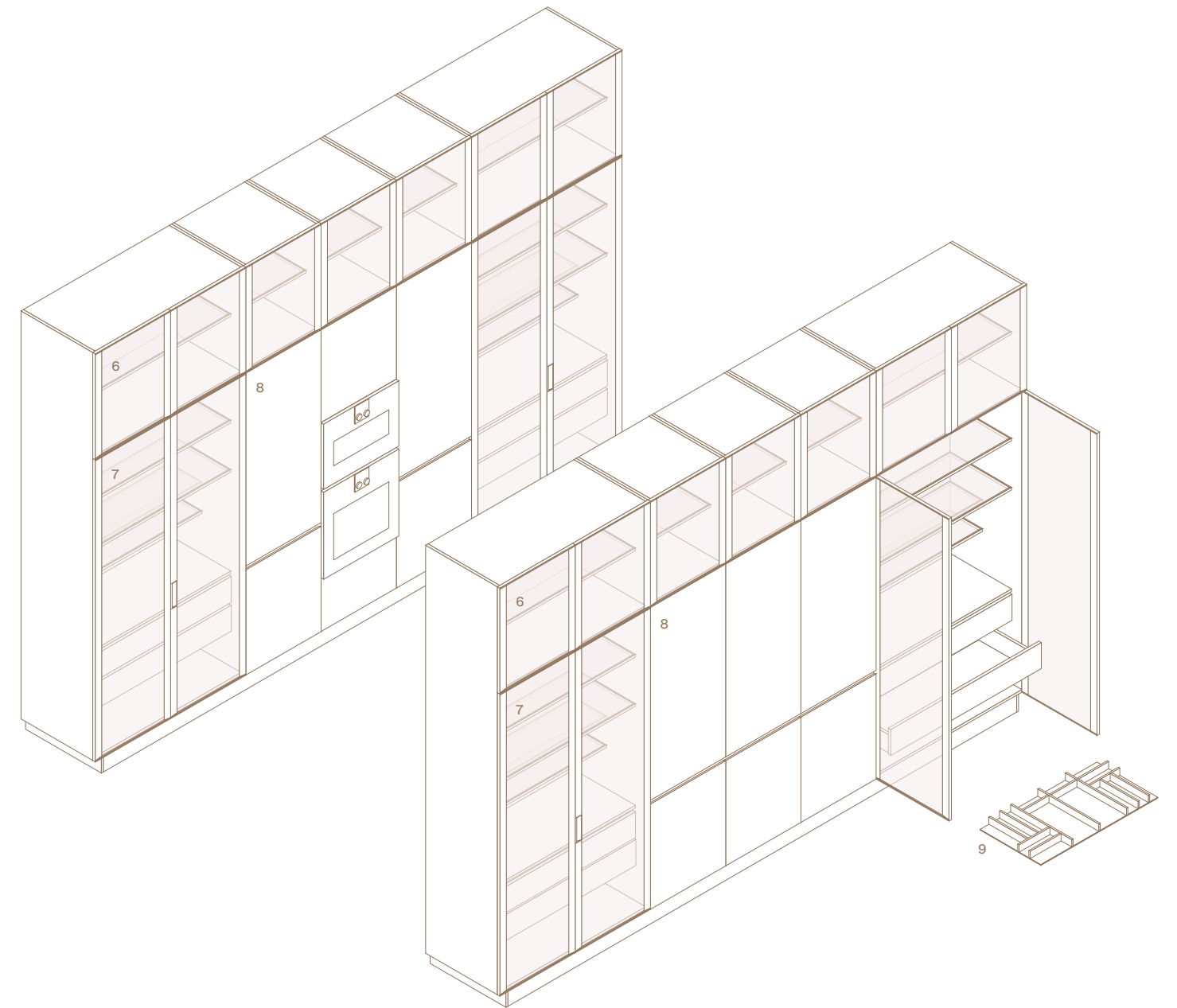

PHOENIX

Da un'intuizione progettuale di Poliform nasce Phoenix, una cucina caratterizzata dal particolare disegno dell'apertura a gola, di volta in volta personalizzato. Una soluzione innovativa, capace di trasformare un dettaglio tecnico in un dettaglio estetico che si armonizza con ogni tipologia di finitura, dall'acciaio al massello, e con tutti gli altri elementi della cucina.

From a project intuition of Poliform arises Phoenix, a kitchen characterised by the particular design of the groove opening, customised each time. An innovative solution, able to transform a technical detail into an aesthetic detail that harmonises with every type of finish, from steel to solid wood, and with all the other elements of the kitchen.

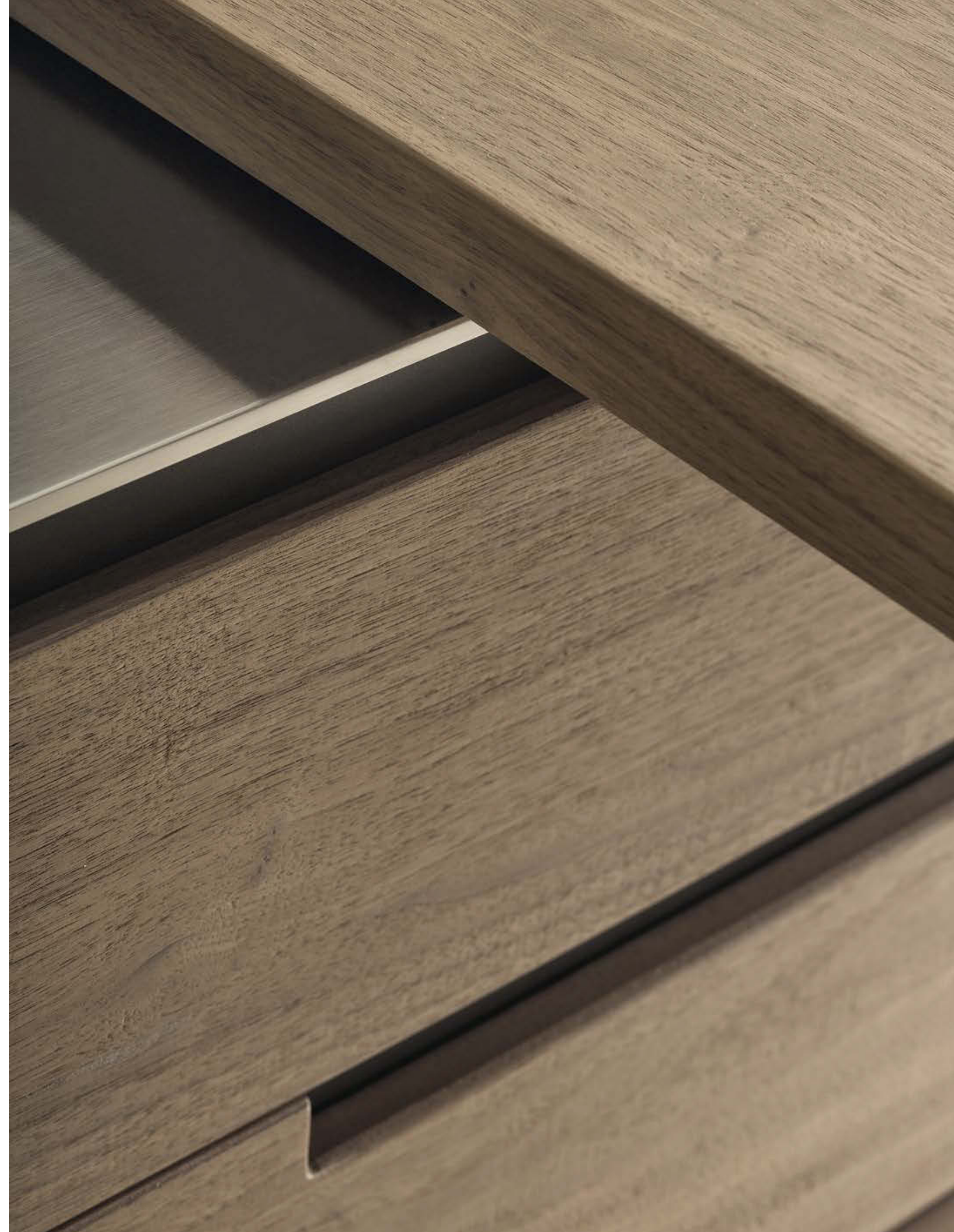



Qui e nella pagina precedente: isola centrale con basi ribassate, estrattori, cassetti e fianchi di finitura in massello di noce canaletto termico, gole laccato goffrato moka, piano Bold in marmo calacatta oro lucido attrezzato con Deep Shaker Plain con cappa integrata. Snack Blade in massello di noce canaletto termico. Sedie Seattle in cuoio sfoderabile 08 fango. Colonne High con ante battenti e a scomparsa in laccato goffrato ghiaccio, basi con ante e fianchi di finitura in massello di noce canaletto termico, top in acciaio scotch brite attrezzato con Deep Shaker Plain.

This and previous page: central island with low base units, pull-out baskets, drawers and finishing sides in solid thermo treated walnut canaletto, embossed lacquered moka channels, Bold top in glossy marble calacatta oro equipped with Deep Shaker Plain with integrated hood. Blade snack top in solid thermo treated walnut canaletto. Seattle chairs in removable hide 08 fango. High tall units with leaf and retractable doors in embossed mat lacquer ghiaccio, base units with doors and finishing sides in solid thermo treated walnut canaletto, top in scotch brite steel equipped with Deep Shaker Plain.





Deep Shaker Plain è un canale attrezzato con diverse tipologie di attrezzature, tra cui la cappa integrata con vetro fumé personalizzata Poliform. Si utilizza sull'elemento a isola, con qualsiasi modello di cucina Poliform. In questa pagina e nella successiva: Deep Shaker Plain in anodizzato moka, cappa integrata con vetro fumé, dietro il lavello griglia di scolo, scatole in PaperStone® nero con macina spezie e barattoli in ceramica, presa elettrica a scomparsa.

Deep Shaker Plain is a channel fitted with various types of equipment, including the Poliform personalized integrated hood with fumé glass. It is used on the island, with any Poliform kitchen model. This and next page: Deep Shaker Plain in anodized moka, integrated hood with fumé glass, behind the sink drain grid, boxes in PaperStone® nero with spice mill and ceramic jars, retractable electrical socket.





A sinistra: dettaglio del piano Bold, un piano dallo spessore maggiorato da abbinare alle basi ribassate di tutte le cucine Poliform. Dotato di un vaso rastremato per il contenimento dei liquidi. Nella pagina successiva: colonne High con ante a scomparsa in laccato gofrato ghiaccio, interno in noce canaletto termico. Vano a destra, attrezzato a mobile bar, cassetti e piano estraibile in acciaio scotch brite, ripiani in anodizzato nero e olmo nero attrezzati con porta calici, portabottiglie, set vino, set cocktail, porta cialde e barattoli in vetro. Vano a sinistra, attrezzato con forni e ripiani in vetro fumé con telaio in anodizzato nero e luce a led integrata.

Left: close-up of the Bold top, a top with increased thickness to be combined with the low base units of all Poliform kitchens. It is equipped with a tapered drip edge to hold liquids. Next page: High tall units with pocket doors in embossed lacquer ghiaccio, interior in thermo treated walnut canaletto. Right compartment equipped with a bar cabinet, drawers and pull-out top in scotch brite steel, black anodized and black elm shelves equipped with glass holders, bottles holder, wine set, cocktail set, pod holders and glass jars. Left compartment equipped with ovens and fumé glass shelves with black anodized frame and integrated led light.



A destra: dettaglio del piano Bold con canale attrezzato Deep Shaker Plain e delle basi ribassate che consentono di creare in continuità lo snack Blade ad altezza tavolo. Nella pagina successiva: isola centrale con basi ribassate, estrattori, cassetti e fianchi di finitura in massello di noce canaletto termico, gole laccato goffrato moka, piano Bold in marmo calacatta oro lucido attrezzato con Deep Shaker Plain con cappa integrata. Snack Blade in massello di noce canaletto termico. Sedie Seattle in cuoio sfoderabile 08 fango. Colonne High con ante battenti e a scomparsa in laccato goffrato ghiaccio, basi con ante e fianchi di finitura in massello di noce canaletto termico, top in acciaio scotch brite attrezzato con Deep Shaker Plain.

Right: close-up of the Bold top with Deep Shaker Plain equipped channel and low base units which allows the continuity with Blade snack top, at table height. Next page: central island with low base units, pull-out baskets, drawers and finishing sides in solid thermo treated walnut canaletto, embossed lacquered moka channels, Bold top in glossy marble calacatta oro equipped with Deep Shaker Plain with integrated hood. Blade snack top in solid thermo treated walnut canaletto. Seattle chairs in removable hide 08 fango. High tall units with leaf and retractable doors in embossed mat lacquer ghiaccio, base units with doors and finishing sides in solid thermo treated walnut canaletto, top in scotch brite steel equipped with Deep Shaker Plain.

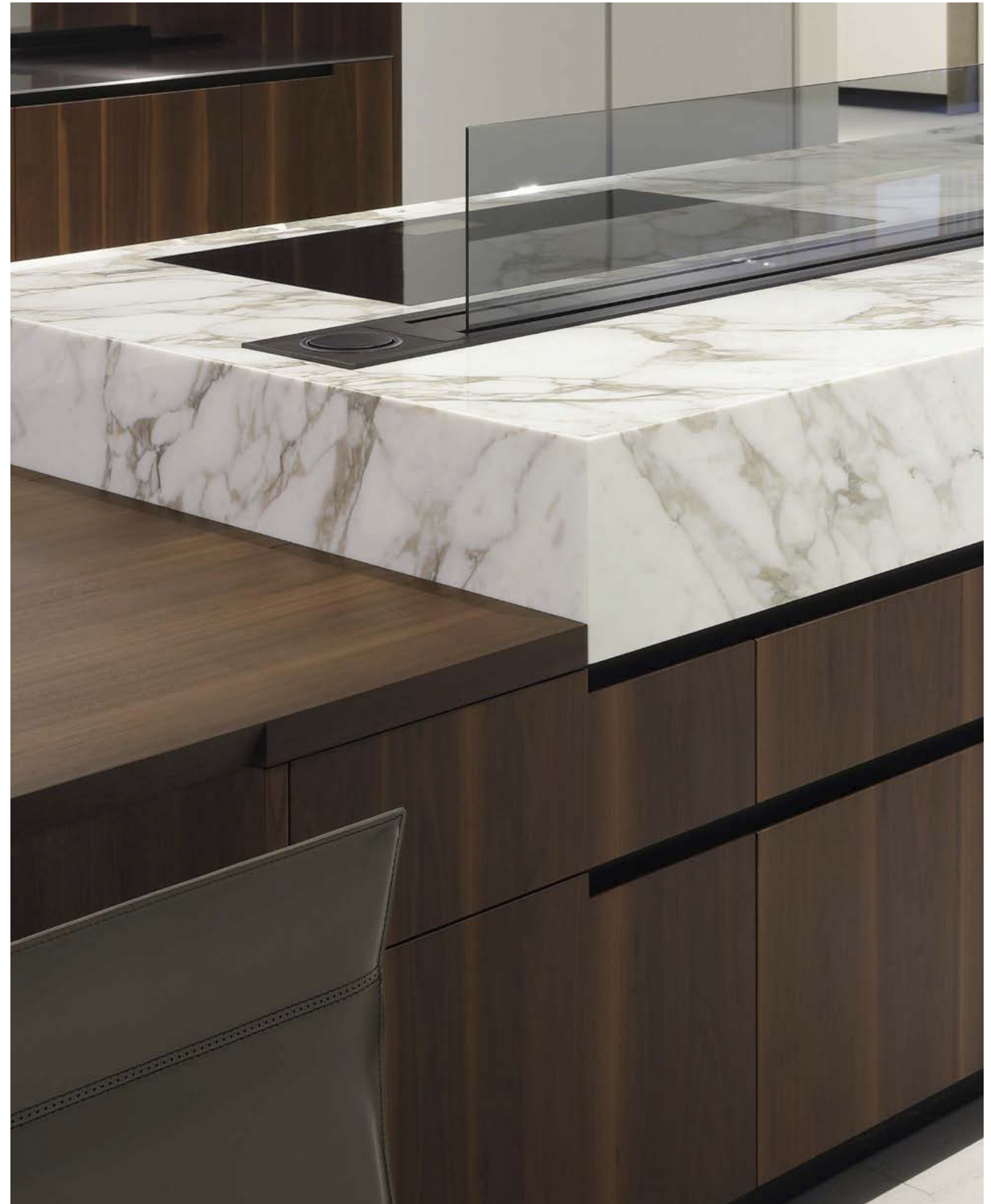



PHOENIX
Design R&D Poliform

Isola p 1280

Strutture: nobilitato grigio lavagna.
Cassetti ed estrattori: massello di noce canaletto termico.
Maniglie: gola laccato goffrato moka.
Fianchi: massello di noce canaletto termico.
Top: Bold in marmo calacatta oro, spessore 215 mm.
Zoccoli: laccato goffrato moka.

Deep Shaker Plain p 186

Strutture: anodizzato moka.
Cappa integrata con vetro fumé.

Snack Blade

Massello di noce canaletto termico.

Colonne High p 740

Strutture: nobilitato grigio lavagna e noce canaletto termico.
Ante: laccato goffrato ghiaccio.
Maniglie: gola verticale laccato goffrato ghiaccio.
Fianchi: laccato goffrato ghiaccio e massello di noce canaletto termico.

Basi tra colonne p 740

Strutture: nobilitato grigio lavagna.
Ante: massello di noce canaletto termico.
Maniglie: gola laccato goffrato moka.
Top: acciaio scotch brite, spessore 6 mm con telaio di supporto in alluminio.

Complementi

Sedia Seattle: cuoio sfoderabile 08 fango.

Island d 50 1/2"

Structures: grey lavagna melamine.
Drawers and pull-out storage baskets: solid thermo treated walnut canaletto.
Handles: channel embossed lacquer moka.
Sides: solid thermo treated walnut canaletto. Top: Bold in marble calacatta oro, thickness 8 1/2".
Plinths: embossed lacquer moka.

Deep Shaker Plain d 7 1/4"

Structures: anodized moka.
Integrated hood with fumé glass.

Blade snack

Solid thermo treated walnut canaletto.

High tall units p 29 1/4"

Structures: grey lavagna melamine and thermo treated walnut canaletto.
Doors: embossed lacquer ghiaccio.
Handles: vertical channel embossed lacquer ghiaccio.
Sides: embossed lacquer ghiaccio and solid thermo treated walnut canaletto.

Base units between tall units d 29 1/4"

Structures: grey lavagna melamine.
Doors: solid thermo treated walnut canaletto.
Handles: channel embossed lacquer moka.
Top: scotch brite steel, thickness 1/4" with aluminium support frame.

Accessories

Seattle chair: removable hide 08 fango.

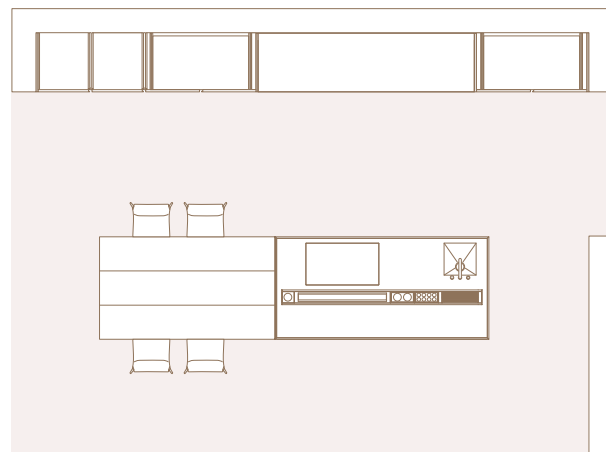
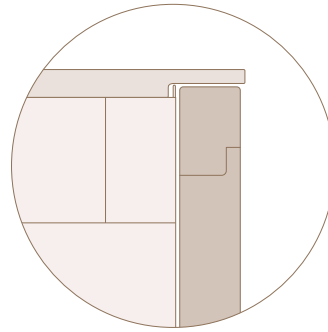
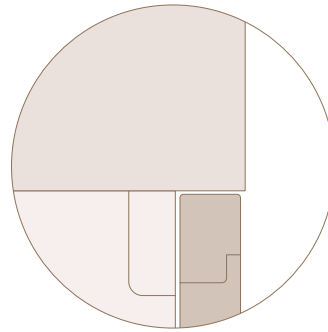

Isola Island

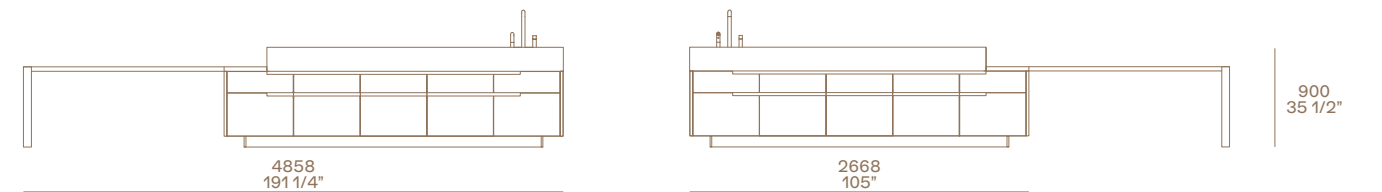

Colonne High e basi High tall units and base units

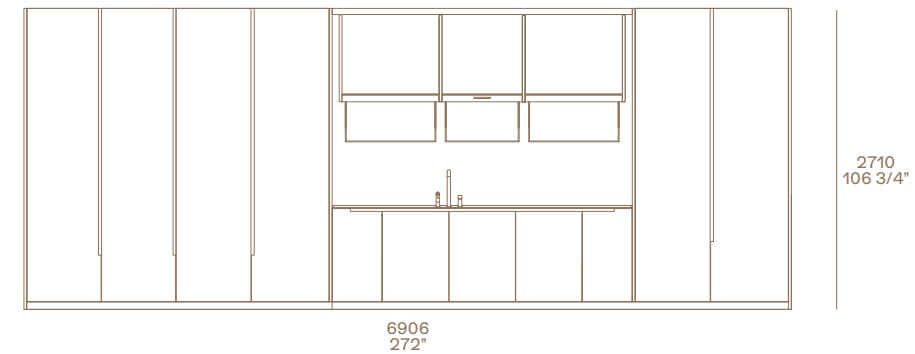

Seattle
Design Jean-Marie Massaud

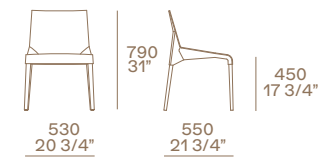

- 1 Basi ribassate con cassetti ed estrattori.
- 2 Piano Bold h 215 mm.
- 3 Deep Shaker Plain con cappa integrata.
- 4 Piano cottura a induzione, incasso filotop.
- 5 Lavello in acciaio scotch brite, incasso sottotop.

- 6 Attrezzatura interna in noce canaletto e alluminio anodizzato moka.
- 7 Snack Blade 1280 x 2190 mm.
- 8 Colonne High con mobile bar, forni, frigo, congelatore con ante ad apertura battente e a scomparsa.

- 9 Basi con ante.
- 10 Lavello integrato in acciaio scotch brite.
- 11 Gocciolatoio in PaperStone® nero.
- 12 Mensola Bridge.

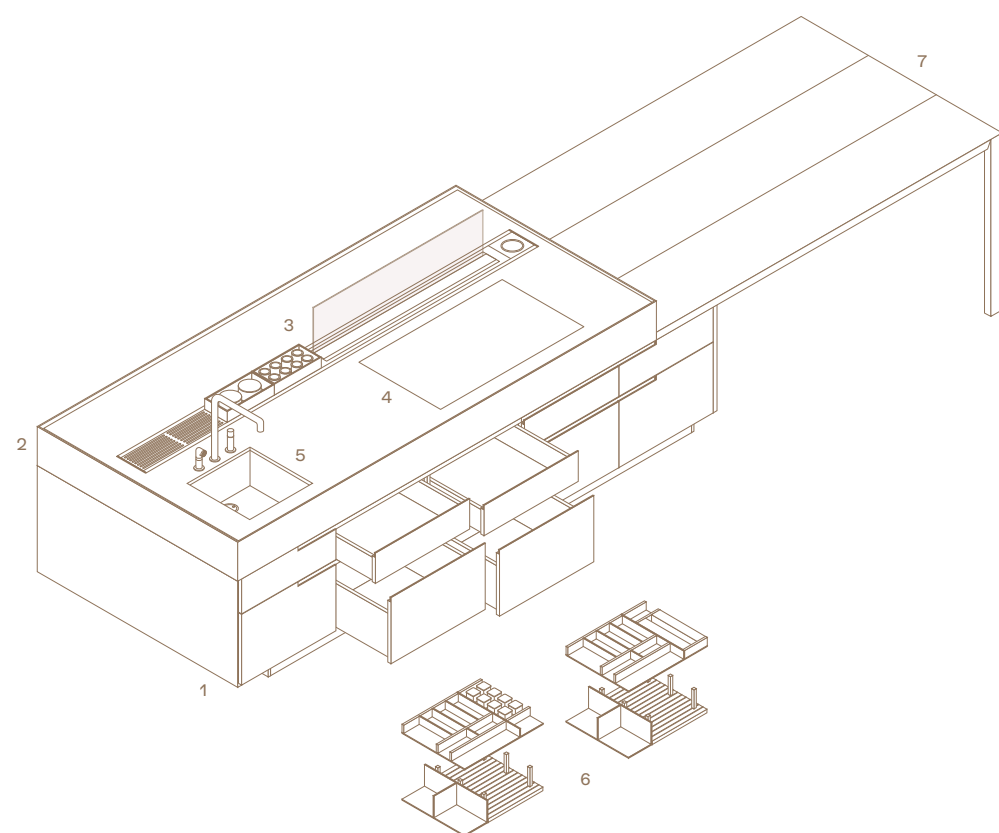

- 1 Low base units with drawers and pull-out storage baskets.
- 2 Bold top h 8 1/2".
- 3 Deep Shaker Plain with integrated hood.
- 4 Induction hob, flush built-in.
- 5 Sink in scotch brite steel, with undermount built-in.

- 6 Inner equipment in walnut canaletto and moka anodized aluminium.
- 7 Blade snack 50 1/2" x 86 1/4".
- 8 High tall units with bar cabinet, ovens, fridge, freezer with doors with leaf opening and pocket doors.

- 9 Base units with doors.
- 10 Integrated sink in scotch brites steel.
- 11 Drip tray in PaperStone® nero.
- 12 Bridge shelf.

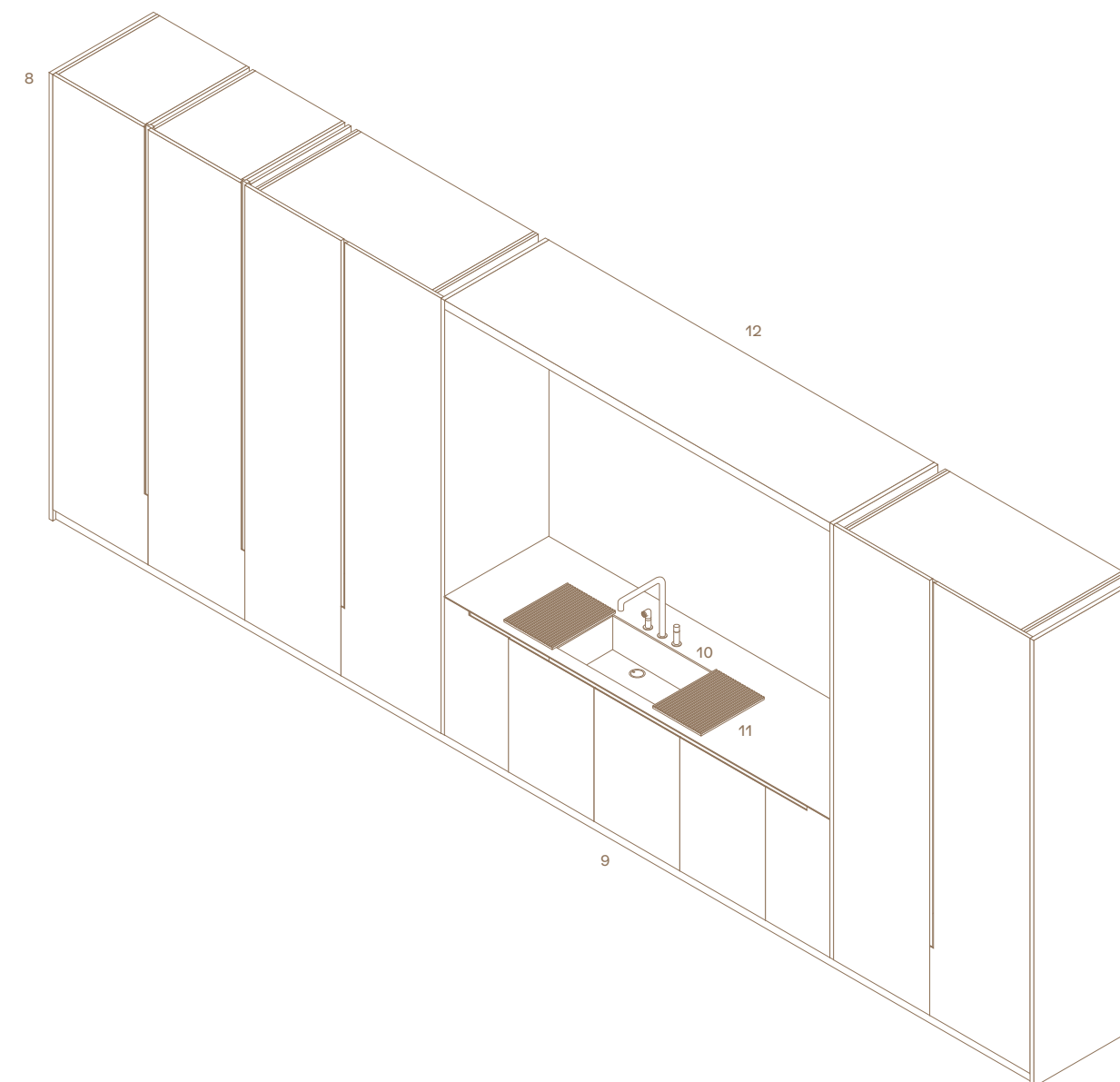

Qui e nella pagina successiva: basi con ante, cassetti ed estrattori in acciaio scotch brite e gola in laccato goffrato carbone, piano in acciaio scotch brite con telaio di supporto in laccato goffrato carbone. Cappa Factory a isola in acciaio scotch brite. Colonne High con ante in olmo nero e gole verticali in laccato goffrato carbone. La colonna a sinistra ha ante a scomparsa e vano attrezzato con Shaker portabicchieri, ripiani in alluminio anodizzato moka e schienale in olmo nero. In appoggio sulle basi, piano snack Blade in olmo nero. Sgabelli Ventura in olmo nero con seduta rivestita in pelle non sfoderabile Soft 4 cognac. Tavolino Dama in legno massello noce canaletto.

This and next page: base units with doors, drawers and pull-out storage baskets in scotch brite steel and channel in embossed lacquer carbone, top in scotch brite steel with embossed lacquered carbone support frame. Factory island-hood in scotch brite steel. High tall units with doors in black elm and vertical channels in embossed lacquer carbone. The tall unit on the left has pocket doors and an equipped compartment with Shaker cup holder, shelves in moka anodized aluminium and back panel in black elm. On the base units is the Blade snack top in black elm. Ventura stools in black elm with seat covered in non-removable leather Soft 4 cognac. Dama small table in solid walnut canaletto.







A sinistra: dettaglio del piano snack Blade in olmo nero, in appoggio sulle basi. Sgabelli Ventura in olmo nero con seduta rivestita in pelle non sfoderabile Soft 4 cognac.

Left: close-up of Blade snack top in black elm, placed on the base units. Ventura stools in black elm with seat covered in non-removable leather Soft 4 cognac.



Qui e nella pagina precedente: basi con ante, cassetti ed estrattori in acciaio scotch brite e gola in laccato gofrato carbone. Cappa Factory a isola in acciaio scotch brite. Colonne High con ante in olmo nero e gola verticale in laccato gofrato carbone. In appoggio sulle basi, piano snack Blade in olmo nero. Sgabelli Ventura in olmo nero con seduta rivestita in pelle non sfoderabile Soft 4 cognac. Tavolino Dama in legno massello noce canaletto.

This and previous page: base units with doors, drawers and pull-out storage baskets in scotch brite steel and channel in embossed lacquer carbone. Factory island-hood in scotch brite steel. High tall units with doors in black elm and vertical channel in embossed lacquer carbone. Blade snack top in black elm placed on the base units. Ventura stools in black elm with seat covered in non-removable leather Soft 4 cognac. Dama small table in solid walnut canaletto.





A sinistra: dettaglio della base con cassetti. Frontale in acciaio scotch brite, piano in acciaio scotch brite con telaio di supporto in laccato goffrato carbone, fianco di finitura in acciaio scotch brite. Nella pagina successiva: dettaglio dell'attrezzatura per cassetti con portaposate in wengé, bilancia elettronica in acciaio e contenitori in ceramica.

Left: close-up of the base unit with drawers. Front profile in scotch brite steel, top in scotch brite steel with embossed lacquered carbone support frame, scotch brite steel on the side. Next page: close-up of the drawer equipment with wenge cutlery tray, electronic steel scale and ceramic containers.



PHOENIX
Design R&D Poliform

Basi p 1280
Strutture: nobilitato grigio lavagna.
Ante, cassetti ed estrattori: acciaio scotch brite.
Maniglie: gola laccato goffrato carbone.
Fianchi: acciaio scotch brite Barazza, spessore 6 mm.
Top: acciaio scotch brite Barazza con telaio di supporto laccato goffrato carbone, spessore 6 mm.
Zoccoli: laccato goffrato carbone.

Snack Blade
Massello tinto olmo nero.

Colonne con forni p 640
Strutture: nobilitato grigio lavagna.
Ante: olmo nero.
Maniglie: gola verticale laccato goffrato carbone.
Fianchi: olmo nero, spessore 26 mm.

Colonne High p 740
Strutture: nobilitato grigio lavagna.
Ante: olmo nero.
Maniglie: gola verticale laccato goffrato carbone.
Fianchi: olmo nero, spessore 26 mm.

Complementi
Sgabello Ventura: struttura in olmo nero e rivestimento non sfoderabile in pelle Soft 4 cognac.
Tavolino Dama: legno massello noce canaletto.

Base units d 50 1/2"
Structures: grey lavagna melamine.
Doors, drawers and pull-out storage baskets: scotch brite steel.
Handles: channel in embossed lacquer carbone.
Sides: Barazza scotch brite steel, thickness 1/4". Top: Barazza scotch brite steel with support frame in embossed lacquer carbone, thickness 1/4".
Plinths: embossed lacquer carbone.

Blade snack
Solid wood dyed black elm.

Tall units with ovens d 25 1/4"
Structures: grey lavagna melamine.
Doors: black elm.
Handles: vertical channel in embossed lacquer carbone.
Sides: black elm, thickness 1".

High tall units d 29 1/4"
Structures: grey lavagna melamine.
Doors: black elm.
Handles: vertical channel in embossed lacquer carbone.
Sides: black elm, thickness 1".

Accessories
Ventura stool: structure in black elm and non-removable cover in leather Soft 4 cognac.
Dama coffee table: solid walnut canaletto.

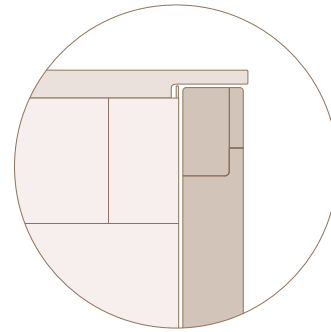

Basi
Base units

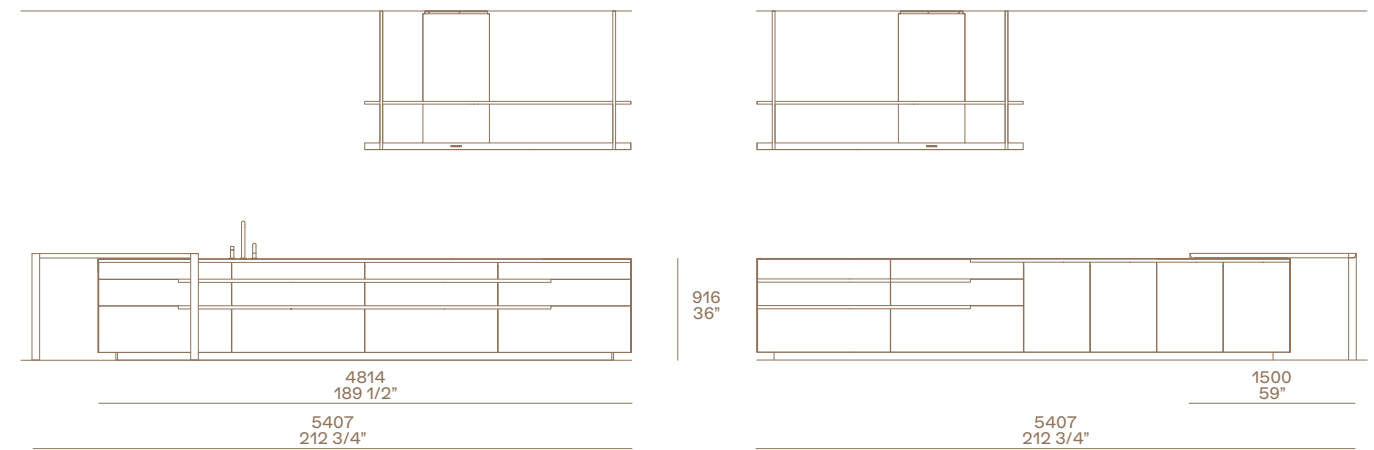

Colonne
Tall units

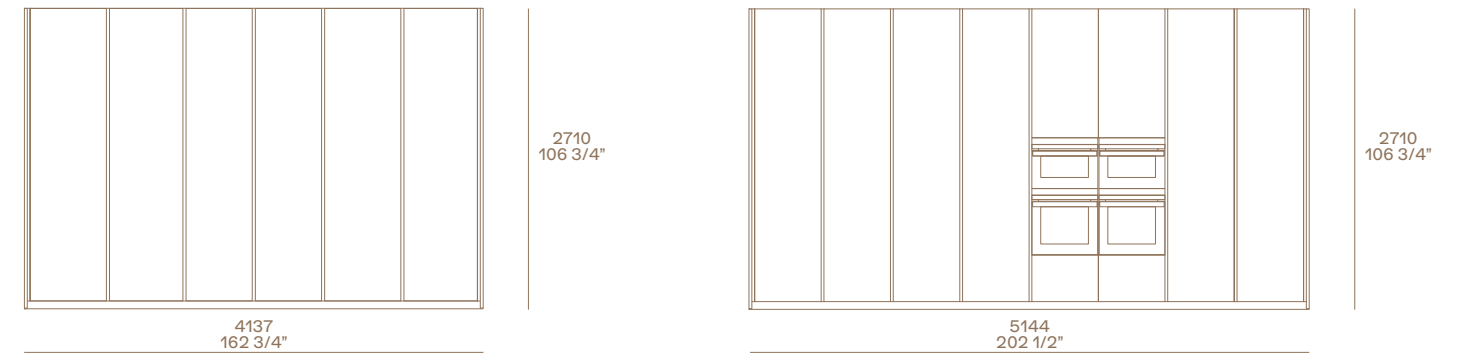

Ventura
Design Jean-Marie Massaud

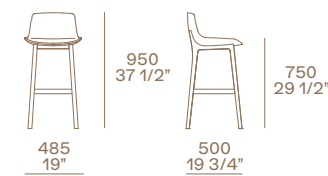

Dama
Design R&D Poliform

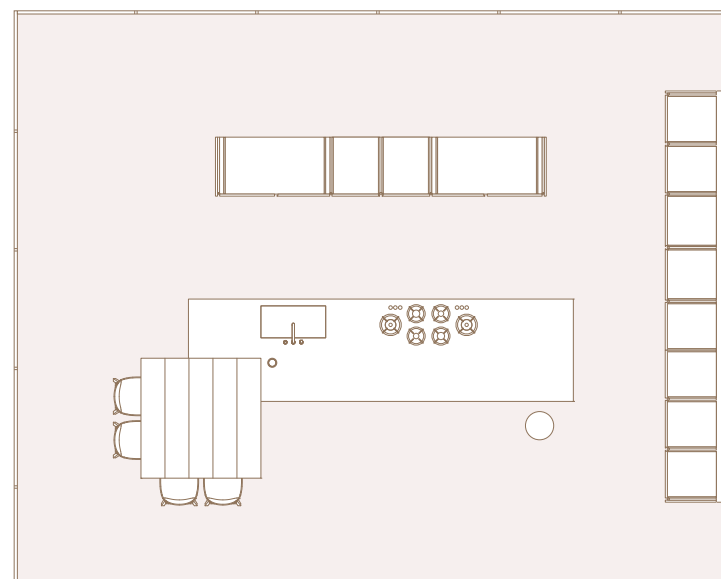

- 1 Colonne High, laterali con ante a scomparsa, centrali con ante ad apertura battente. Vano attrezzato con cassetti, Shaker portacalici e ripiani.
- 2 Lavello in acciaio scotch brite saldato.

- 3 Piano cottura Pitt Cooking®, 6 fuochi, con manopole personalizzate Poliform.
- 4 Presa elettrica a scomparsa.
- 5 Attrezzatura in wengé e acciaio per cassetti ed estrattori.

- 6 Cappa Factory a isola in acciaio scotch brite, personalizzata Poliform.
- 7 Snack Blade quadrato 1500 × 1500 mm.
- 8 Colonne High con forni e frigoriferi attrezzate con cassetti e ripiani, con ante ad apertura battente.

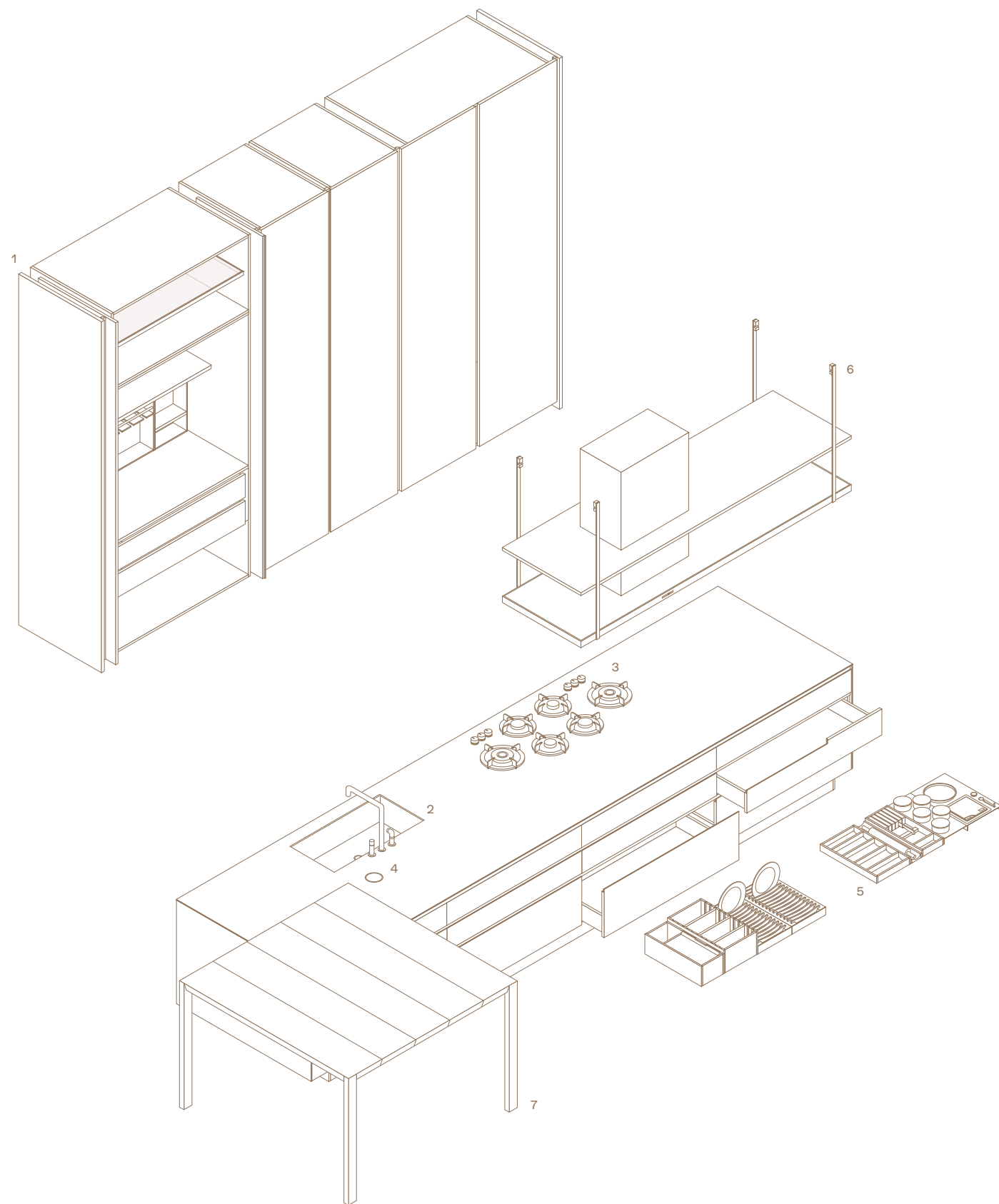

- 1 High tall units, lateral with pocket doors, central with leaf opening. Compartment equipped with drawers, chalices rack Shaker and shelves.
- 2 Soldered scotch brite steel sink.

- 3 Hob Pitt Cooking® 6 burners, Poliform personalized controls.
- 4 Lift-up power socket.
- 5 Equipment in wenge and steel for drawers and pull-out storage baskets.

- 6 Island-hood Factory in scotch brite steel, personalized Poliform.
- 7 Square snack Blade 59" x 59".
- 8 High tall units with ovens and refrigerators, equipped with drawers and shelves, leaf doors.

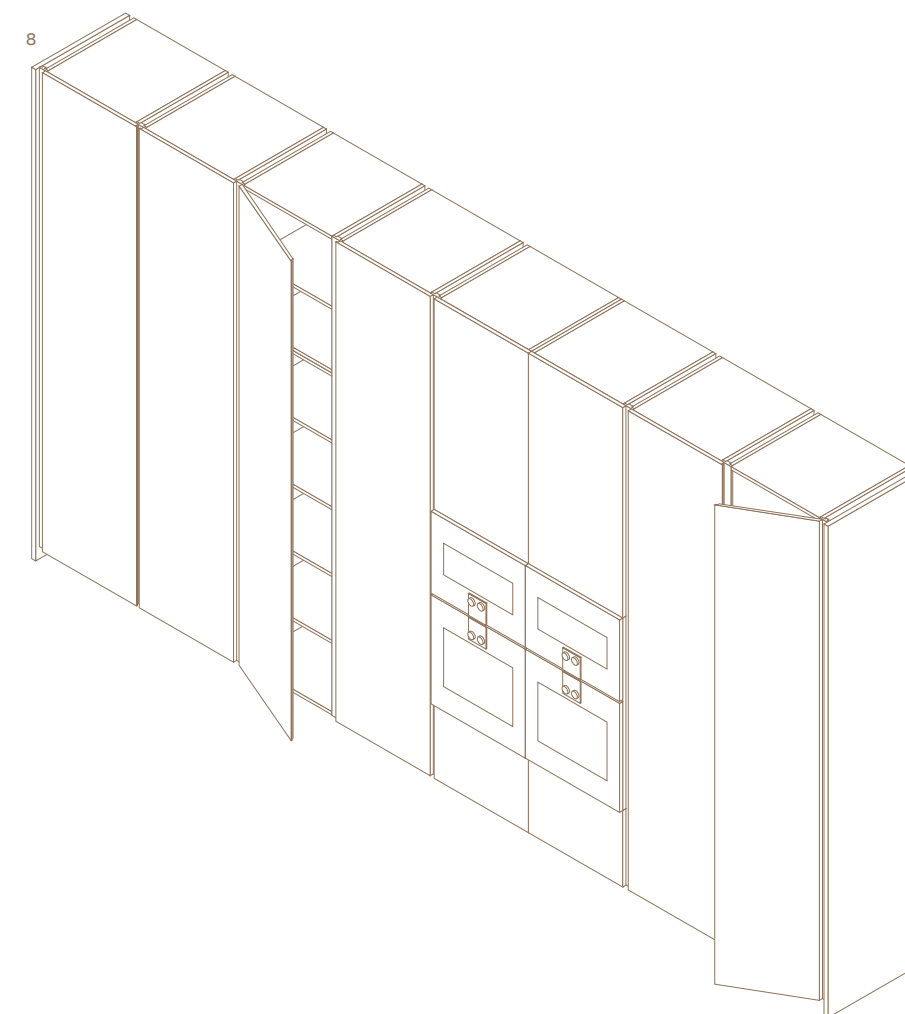

ALEA PRO

Restyling dello storico e consolidato modello Alea, Alea Pro si caratterizza per l'espressività più marcata. Il design lineare del sistema originario è stato reinterpretato alla luce di una ridefinizione dei dettagli, in particolare delle gole di apertura, sottolineate da una sagoma che evidenzia le linee verticali e orizzontali. Nuovo è il disegno dell'anta con bordo superiore rastremato e profilo maniglia abbinato alla gola, così come il particolare del fianco distanziato, che dà un aspetto più leggero alle basi. Le ante vetrina per basi, pensili e colonne creano giochi di trasparenze che danno ritmo alla composizione. Il risultato è un sistema cucina che unisce all'altissima capacità operativa un aspetto contemporaneo, da personalizzare con una vastissima gamma di materiali e finiture.

A restyling of the iconic and consolidated Alea model, Alea Pro is characterized by the most marked expressiveness. A redefinition of the details reinterprets the linear design of the original system, in particular of the opening channels, underlined by a profile that emphasizes the vertical and horizontal lines. The door design with a chamfered upper edge upper edge and handle profile matched to the channel is new, as is the detail of the spaced side panel, which gives a lighter look to the base units. The display doors for base units, wall units, and tall units create plays of transparency that give rhythm to the composition. The result is a kitchen system that combines a very high operational capacity with a contemporary look, to be customized with a very wide range of materials and finishes.

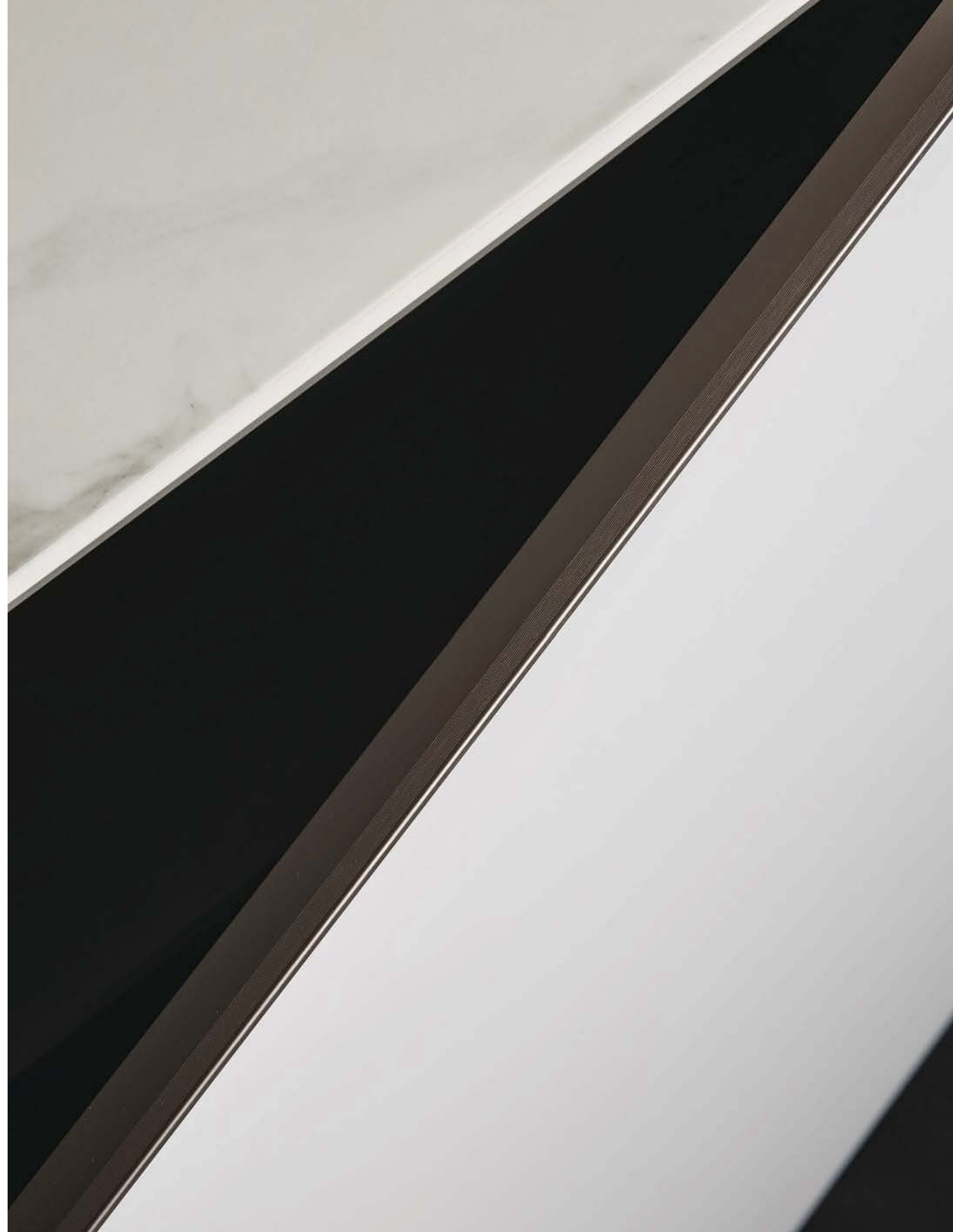





Qui, nella pagina precedente e nelle successive: isola centrale con estrattori, ante, fianchi di finitura e top in Inalco MDi® stone brown, profilo maniglia, gola orizzontale e verticale terminale in anodizzato moka, piano snack Sydney in massello di noce canaletto. Sistema modulare Infinity personalizzato Poliform con modulo aspirante luminoso e moduli luminosi, finitura acciaio scotch brite e vetro fumé. Sgabelli Seattle in cuoio non sfoderabile 29 tortora, poggiapiedi in cromo satinato. Basi a parete con ante, fianchi di finitura e top in Inalco MDi® stone brown con profilo maniglia, gola orizzontale e verticale terminale in anodizzato moka. Deep Shaker in anodizzato moka con schienale in Inalco MDi® stone brown, mensola Bridge in laccato gofrato moka e boiserie in Inalco MDi® stone brown. Colonne con ante ed estrattori in acciaio PVD bronzo Ronda con gole verticali in anodizzato moka. Colonne con ante vetrina PR24 in anodizzato moka e vetro riflettente fumé, con struttura interna in noce canaletto naturale, ripiani in vetro fumé con telaio in anodizzato nero e cassettera in laminato opaco touch nero, illuminazione a led integrata.

This, previous and next pages: central island with pull-out baskets, doors, finishing sides and worktop in Inalco MDi® stone brown, handle profile, horizontal and lateral vertical channel anodized moka, Sydney snack worktop in solid walnut canaletto. Modular system Infinity, personalized Poliform, with lighted extractor module and lighted modules scotch brite steel finish and glass fumé. Seattle stools in non-removable hide 29 tortora, footrest in satin chrome. Wall base units with doors, finishing sides and worktop in Inalco MDi® stone brown with handle profile, horizontal and lateral vertical channel anodized moka. Deep Shaker anodized moka with back panel in Inalco MDi® stone brown, Bridge shelf in embossed lacquer moka and wall panelling in Inalco MDi® stone brown. Tall units with doors and pull-out baskets in PVD steel bronzo Ronda with anodized moka vertical channels. Tall units with glass doors PR24 anodized moka and fumé reflective glass, with inner structure in natural walnut canaletto, shelves in glass fumé with black anodized frame and chest of drawers in nero touch mat laminate, integrated led light.



A destra: dettaglio del piano snack Sydney in massello di noce canaletto in appoggio sul top Inalco MDi® stone brown, sgabelli Seattle in cuoio non sfoderabile 29 tortora con poggiapiedi in cromo satinato.

Right: close-up of the Sydney snack top in solid walnut canaletto placed on the top Inalco MDi® stone brown, Seattle stools in non-removable hide 29 tortora with footrest in satin chrome.





A sinistra: dettaglio dell'isola centrale con estrattori, fianchi di finitura e top in Inalco MDi® stone brown, profilo maniglia, gola orizzontale e verticale terminale in anodizzato moka. Piano snack Sydney in massello di noce canaletto e sgabelli Seattle in cuoio non sfoderabile 29 tortora con poggiatesta in cromo satinato.

Left: close-up of the central island with pull-out storage baskets, finishing sides and top in Inalco MDi® stone brown, handle profile, horizontal and vertical terminal channel in anodized moka. Sydney snack top in solid walnut canaletto and Seattle stools in non-removable hide 29 tortora with footrest in satin chrome.



Qui e nella pagina precedente: basi a parete con ante, fianchi di finitura e top in Inalco MDi® stone brown con profilo maniglia, gola orizzontale e verticale terminale in anodizzato moka. Basi a parete attrezzate con Deep Shaker in anodizzato moka con schienale in Inalco MDi® stone brown, mensola Bridge in laccato goffrato moka e boiserie in Inalco MDi® stone brown. Colonne con ante ed estrattori in acciaio PVD bronzo Ronda con gole verticali in anodizzato moka. Colonne con ante vetrina PR24 in anodizzato moka e vetro riflettente fumé, con struttura interna in noce canaletto naturale, ripiani in vetro fumé con telaio in anodizzato nero e cassettera in laminato opaco touch nero, illuminazione a led integrata.

This and previous page: wall base units with doors, finishing sides and worktop in Inalco MDi® stone brown with handle profile, horizontal and lateral vertical channel anodized moka. Wall base units equipped with Deep Shaker anodized moka with back panel in Inalco MDi® stone brown, Bridge shelf in embossed lacquer moka and wall panelling in Inalco MDi® stone brown. Tall units with doors and pull-out baskets in PVD steel bronzo Ronda with anodized moka vertical channels. Tall units with glass doors PR24 anodized moka and fumé reflective glass, with inner structure in natural walnut canaletto, shelves in glass fumé with black anodized frame and chest of drawers in nero touch mat laminate, integrated led light.





A sinistra: dettaglio di Deep Shaker in anodizzato moka con schienali in Inalco MDi® stone brown e tubi in laccato goffrato moka. Pannelli fissi retro lavello e ante a ribalta in laccato goffrato moka, cassettini e ripiani in noce canaletto.

Left: close-up of the Deep Shaker in anodized moka with backs in Inalco MDi® stone brown and embossed lacquered moka bars. Fixed panels behind the sink and flap doors in embossed lacquer moka, small drawers and shelves in walnut canaletto.



A destra: dettaglio dell'estrattore in Inalco MDi® stone brown, con profilo maniglia in anodizzato moka. Cassetto interno in acciaio verniciato brown e attrezzatura in noce canaletto e alluminio anodizzato moka.

Right: close-up of the pull-out storage basket in Inalco MDi® stone brown, with handle profile in anodized moka. Inner drawer in brown painted steel and equipment in walnut canaletto and moka anodized aluminium.





Qui e nelle pagine successive: isola centrale con estrattori, ante, fianchi di finitura e top in Inalco MDi® stone brown, profilo maniglia, gola orizzontale e verticale terminale in anodizzato moka, piano snack Sydney in massello di noce canaletto. Sistema modulare Infinity personalizzato Poliform con modulo aspirante luminoso e moduli luminosi, finitura acciaio scotch brite e vetro fumé. Sgabelli Seattle in cuoio non sfoderabile 29 tortora, poggiatesta in cromo satinato. Colonne con ante ed estrattori in acciaio PVD bronzo Ronda con gole verticali in anodizzato moka. Colonne con ante vetrina PR24 in anodizzato moka e vetro riflettente fumé, con struttura interna in noce canaletto naturale, ripiani in vetro fumé con telaio in anodizzato nero e cassettera in laminato opaco touch nero, illuminazione a led integrata. Tavolo Blade in massello di noce canaletto. Sedie Seattle in cuoio non sfoderabile 26 invecchiato.

This and next pages: central island with pull-out baskets, doors, finishing sides and worktop in Inalco MDi® stone brown, handle profile, horizontal and lateral vertical channel anodized moka, Sydney snack worktop in solid walnut canaletto. Modular system Infinity, personalized Poliform, with lighted extractor module and lighted modules scotch brite steel finish and glass fumé. Seattle stools in non-removable hide 29 tortora, footrest in satin chrome. Tall units with doors and pull-out baskets in PVD steel bronzo Ronda with anodized moka vertical channels. Tall units with glass doors PR24 anodized moka and fumé reflective glass, with inner structure in natural walnut canaletto, shelves in glass fumé with black anodized frame and chest of drawers in nero touch mat laminate, integrated led light. Blade table in solid walnut canaletto. Seattle chairs in non-removable hide 26 invecchiato.



A destra: dettaglio della sedia Seattle con braccioli in cuoio non sfoderabile 26 invecchiato, tavolo Blade in massello di noce canaletto.

Right: close-up of the Seattle chair with armrests in non-removable hide 26 invecchiato, Blade table in solid walnut canaletto.





A sinistra: dettaglio del tavolo Blade in massello di noce canaletto, sedia Seattle con braccioli in cuoio non sfoderabile 26 invecchiato.

Left: close-up of the Blade table in solid walnut canaletto, Seattle chair with armrests in non-removable hide 26 invecchiato.

ALEA PRO
Design R&D Poliform

Isola p 1144, basi a parete p 837

Strutture: nobilitato grigio lavagna.
Ante ed estrattori: Inalco MDi® stone brown, profilo maniglia e gola anodizzato moka.
Fianchi: Inalco MDi® stone brown, spessore 12 mm.
Top: Inalco MDi® stone brown, spessore 12 mm.
Zoccoli: laccato goffrato moka.

Piano snack Sydney

Massello di noce canaletto.

Deep Shaker p 160

Struttura: anodizzato moka.
Schienale: Inalco MDi® stone brown.
Ante a ribalta, tubi: laccato goffrato moka.

Colonne p 640

Strutture: nobilitato grigio lavagna.
Ante ed estrattori: acciaio PVD bronzo Ronda.
Gole verticali: anodizzato moka.
Mensola Bridge: laccato goffrato moka.

Colonne vetrina PR24 p 640

Struttura: noce canaletto naturale.
Ante: telaio anodizzato moka e vetro riflettente fumé.
Ripiani: vetro fumé e telaio anodizzato nero.
Cassettiere: laminato opaco touch nero.

Complementi

Sgabello Seattle: cuoio non sfoderabile 29 tortora.
Tavolo Blade: massello di noce canaletto.
Sedia Seattle: cuoio non sfoderabile 26 invecchiato.

Island d 45", wall base units d 33"

Structures: grey lavagna melamine.
Doors and pull-out storage baskets: Inalco MDi® stone brown, handle profile and channel anodized moka.
Sides: Inalco MDi® stone brown, thickness 1/2". Top: Inalco MDi® stone brown, thickness 1/2".
Plinths: embossed lacquer moka.

Sydney snack top

Solid walnut canaletto.

Deep Shaker d 6 1/4"

Structure: anodized moka.
Back panel: Inalco MDi® stone brown.
Flap doors, bars: embossed lacquer moka.

Tall units d 25 1/4"

Structures: grey lavagna melamine.
Doors and pull-out storage baskets: PVD steel bronzo Ronda.
Vertical channels: anodized moka.
Bridge shelf: embossed lacquer moka.

Tall unit with glass doors PR24 d 25 1/4"

Structure: natural walnut canaletto.
Doors: moka anodized frame and fumé reflective glass. Shelves: fumé glass and black anodized frame.
Chests of drawers: mat laminate touch nero.

Accessories

Seattle stool: non-removable hide 29 tortora.
Blade table: solid walnut canaletto.
Seattle chair: non-removable hide 26 invecchiato.

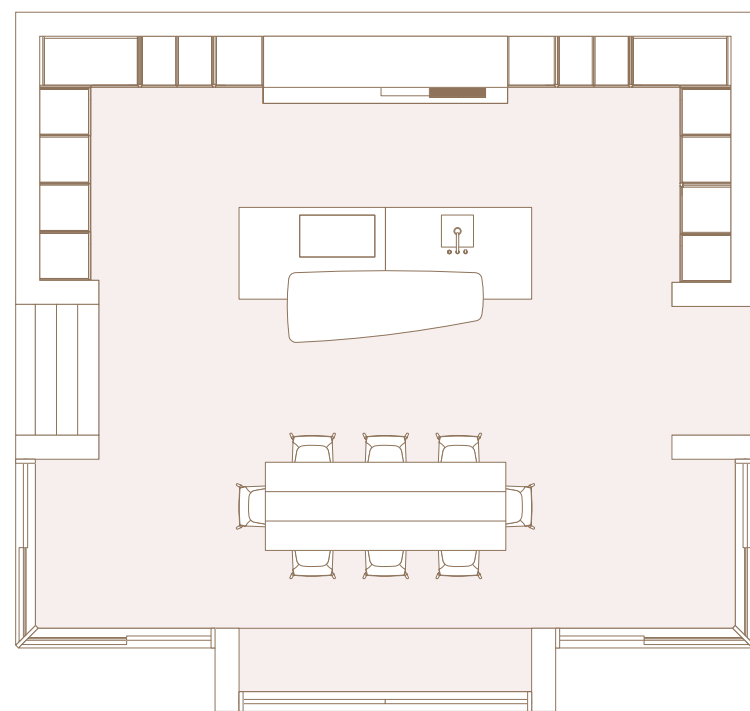
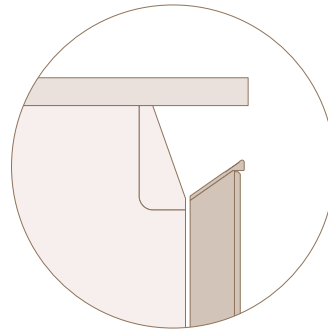

Isola Island

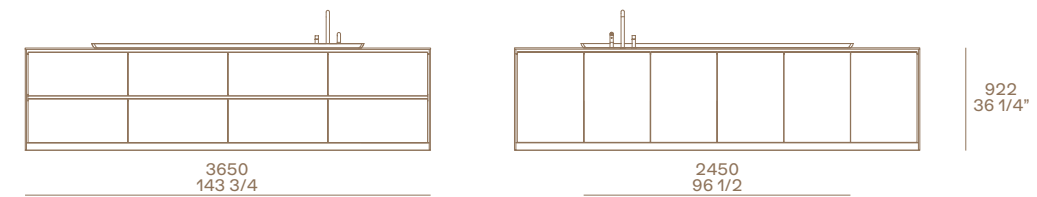

Basi a parete, Deep Shaker, colonne Wall base units, Deep Shaker, tall units

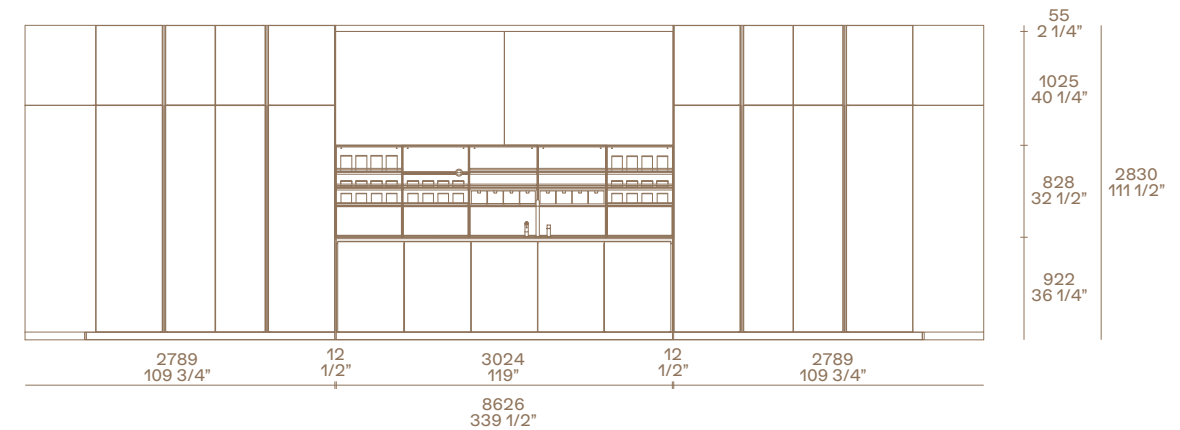

Colonne Tall units

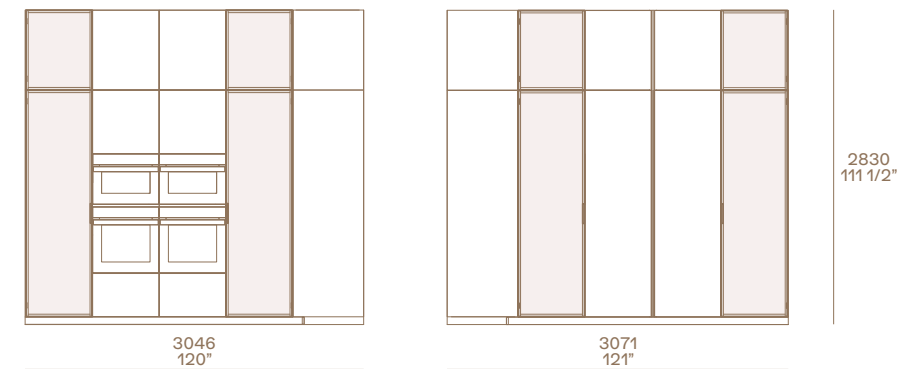

Blade Design Jean-Marie Massaud

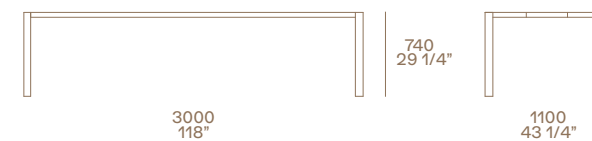

Seattle Design Jean-Marie Massaud

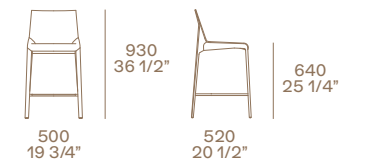

Seattle Design Jean-Marie Massaud

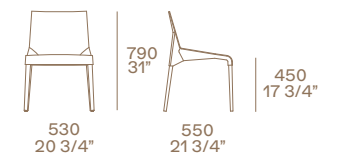

- 1 Basi con ante ed estrattori.
- 2 Piano cottura a induzione, incasso filotop.
- 3 Lavello integrato in Inalco MDi® stone brown.
- 4 Gocciolatoio in PaperStone® nero.
- 5 Attrezzatura in noce canaletto e alluminio anodizzato moka per cassetti interni ed estrattori.

- 6 Piano snack Sydney 2450 × 895 mm.
- 7 Deep Shaker, moduli con schienale in Inalco MDi® e ante fisse retro lavello.
- 8 Boiserie in Inalco MDi®.
- 9 Mensola Bridge.
- 10 Colonne con ante ad apertura battente e con gola verticale.

- 11 Elementi sopra colonna con ante ad apertura tip-on e con gola verticale.
- 12 Colonne con ante vetrina PR24 con ripiani interni e cassettiere.
- 13 Colonne con forni, con ante ed estrattori.
- 14 Colonne con frigo e congelatore.

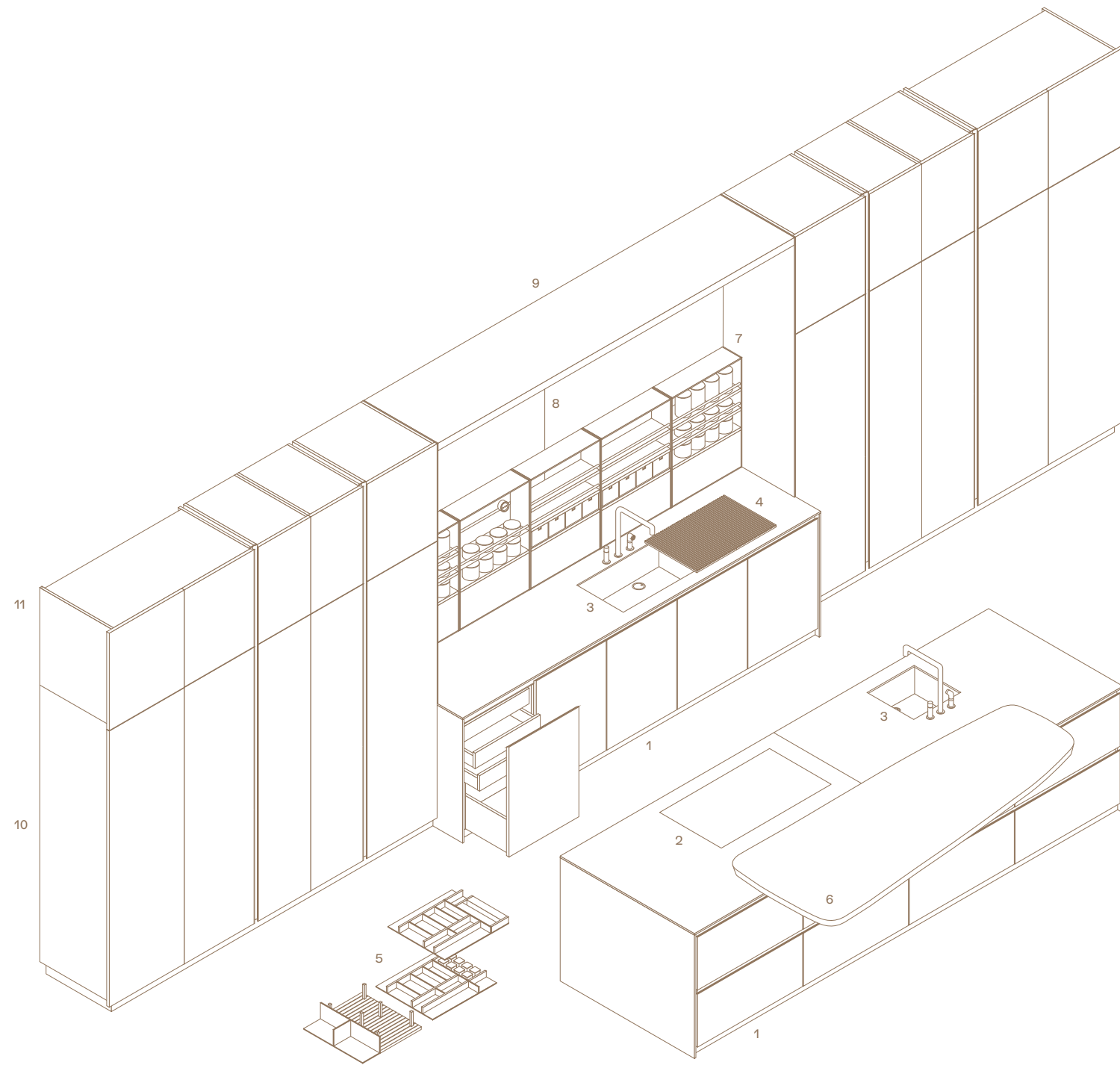

- 1 Base units with doors and pull-out storage baskets.
- 2 Induction hob, fully flush built-in.
- 3 Integrated sink in Inalco MDi® stone brown.
- 4 Drip tray in PaperStone® nero.
- 5 Equipment in walnut canaletto and moka anodized aluminium for inner drawers and pull-out storage baskets.

- 6 Sydney snack top 96 1/2" x 35 1/4".
- 7 Deep Shaker, modular back panel in Inalco MDi® and fixed panels behind the sink.
- 8 Wall panelling in Inalco MDi®.
- 9 Bridge shelf.
- 10 Tall units with leaf doors and with vertical channel.

- 11 Elements above tall unit with doors with tip-on opening and with vertical channel.
- 12 Tall units with glass doors PR24 with inner shelves and chests of drawers.
- 13 Tall units with ovens, with leaf doors and pull-out storage baskets.
- 14 Tall units with fridge and freezer.

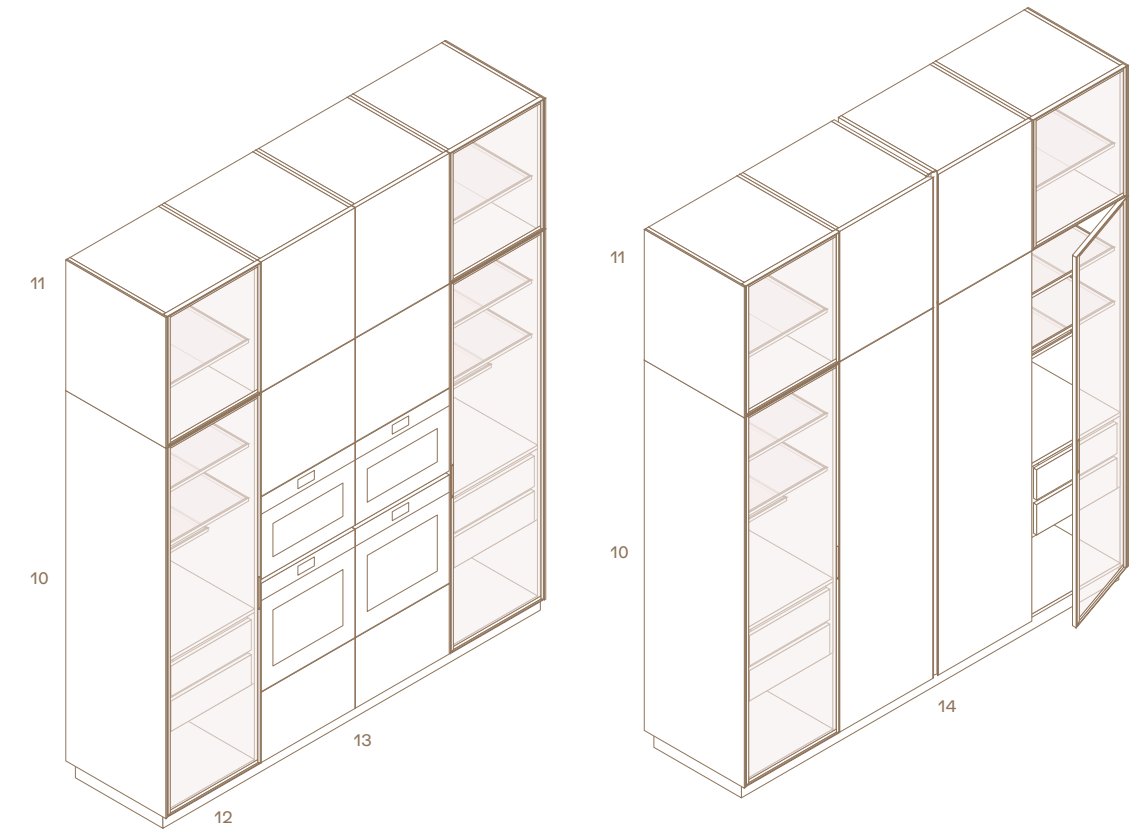

Qui e nella pagina successiva: isola centrale con ante in LCT super white con profilo maniglia e gola in anodizzato champagne, piano a sbalzo Planar in Inalco MDI® calacatta oro touch. Sgabelli Ventura in olmo nero con seduta rivestita in pelle non sfoderabile Silk 10 terracotta. Basi a parete con ante, cassetti ed estrattori in STM champagne, top e fianchi di finitura in laminato tuttocolore touch super white. Pensili con ante vetrina PR24 in anodizzato champagne e vetro riflettente fumé, struttura in nobilitato olmo smoke e illuminazione a led integrata. Sotto ai pensili, Deep Shaker in anodizzato moka e schienali in nobilitato olmo smoke. Sistema modulare Infinity personalizzato Poliform con modulo aspirante luminoso in acciaio scotch brite. Colonne con ante ed estrattori in STM champagne con profilo maniglia e gola in anodizzato champagne.

This and next page: central island with doors in LCT super white with handle profile and channel anodized champagne, jutting-out top Planar in Inalco MDI® calacatta oro touch. Ventura stools in black elm with seat covered in non-removable leather Silk 10 terracotta. Wall base units with doors, drawers and pull-out baskets in STM champagne, top and finishing sides in laminate tuttocolore touch super white. Wall units with showcase doors PR24 in anodized champagne and fumé reflective glass, structure in smoke elm melamine and integrated led lighting. Under the wall units, Deep Shaker in anodized moka and backs in smoke elm melamine. Poliform personalized modular system Infinity with lighted extractor module in steel scotch brite. Tall units with doors and pull-out baskets in STM champagne with handle profile and channel in anodized champagne.





A destra: basi a parete con ante ed estrattori in STM champagne, top e fianchi di finitura in laminato tuttocolore touch super white. Pensili con ante vetrina PR24 in anodizzato champagne e vetro riflettente fumé, struttura in nobilitato olmo smoke e illuminazione a led integrata. Sotto ai pensili, Deep Shaker in anodizzato moka e schienali in nobilitato olmo smoke.

Right: wall base units with doors and pull-out baskets in STM champagne, top and finishing sides in laminate tuttocolore touch super white. Wall units with showcase doors PR24 in anodized champagne and fumé reflective glass, structure in smoke elm melamine and integrated led lighting. Under the wall units, Deep Shaker in anodized moka and backs in smoke elm melamine.





Qui e nella pagina successiva: pensili con ante vetrina PR24 in anodizzato champagne e vetro riflettente fumé, struttura in nobilitato olmo smoke e ripiani in vetro fumé con telaio in anodizzato nero, illuminazione a led integrata. Sotto ai pensili, Deep Shaker in anodizzato moka e schienali in nobilitato olmo smoke con ante a ribalta in laccato goffrato moka, cassettoni in noce canaletto e barattoli in ceramica e vetro con coperchi in noce canaletto. Nella successiva: basi a parete con ante ed estrattori in STM champagne, top e fianchi di finitura in laminato tuttocolore touch super white. Isola centrale con piano a sbalzo Planar in Inalco MDi® calacatta oro touch con gola in anodizzato champagne.

This and next page: wall units with showcase doors PR24 in anodized champagne and fumé reflective glass, structure in smoke elm melamine and shelves in fumé glass with frame in anodized black, integrated led lighting. Under the wall units, Deep Shaker in anodized moka and backs in smoke elm melamine with flap doors in moka embossed lacquer, small drawers in walnut canaletto and ceramic and glass jars with walnut canaletto lids. Next page: wall base units with doors and pull out baskets in STM champagne, top and finishing sides in laminate tuttocolore touch super white. Central island with jutting-out top Planar in Inalco MDi® calacatta oro touch with channel in anodized champagne.



A destra: dettaglio dei pensili vetrina PR24 nella variante con ante a ribalta dotate di cerniera con innovativo meccanismo a scomparsa totale nella struttura. Ante vetrina PR24 in anodizzato champagne e vetro riflettente fumé, struttura in nobilitato olmo smoke e ripiani in vetro fumé con telaio in anodizzato nero, illuminazione a led integrata.

Right: close-up of the wall units with glass door PR24 in the version with flap doors equipped with hinges with an innovative mechanism that completely disappears into the structure. Glass doors PR24 in anodized champagne and fumé reflective glass, structure in smoke elm melamine and shelves in fumé glass with black anodized frame, integrated led light.

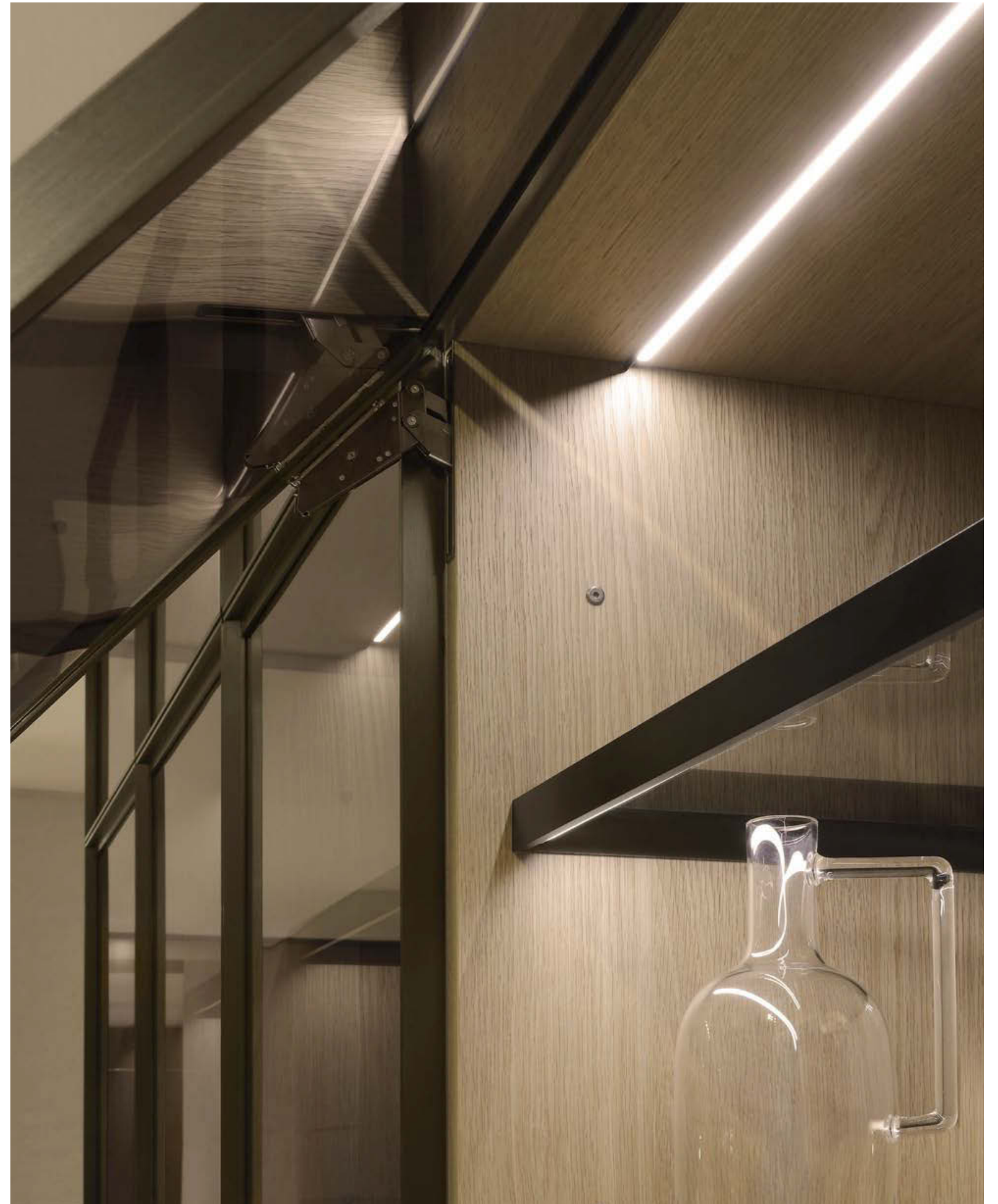



A sinistra: dettaglio di Deep Shaker in anodizzato moka, schienali in nobilitato olmo smoke, anta a ribalta in laccato goffrato moka attrezzata con porta spezie, tubi in laccato goffrato moka, ripiani in noce canaletto, barattoli in ceramica e vetro con coperchi in noce canaletto.

Left: close-up of Deep Shaker in anodized moka, backs in smoke elm melamine, flap door in embossed lacquer moka equipped with spice-holder, bars in embossed lacquer moka, shelves in walnut canaletto, ceramic jars and glass jars with lids in walnut canaletto.

A destra: dettaglio di Deep Shaker con la configurazione a ponte prevista per gli elettrodomestici. Lavello integrato in acciaio per piano in laminato tuttocolore touch super white. Deep Shaker in anodizzato moka, schienali in nobilitato olmo smoke, tubi in laccato gofrato moka, ripiani in noce canaletto, barattoli in ceramica e vetro con coperchi in noce canaletto.

Right: close-up of Deep Shaker with bridge configuration foreseen for electrical appliances. Integrated sink in steel for top in laminate tuttocolore touch super white. Deep Shaker in anodized moka, backs in smoke elm melamine, bars in embossed lacquer moka, shelves in walnut canaletto, jars in ceramic and glass with lids in walnut canaletto.

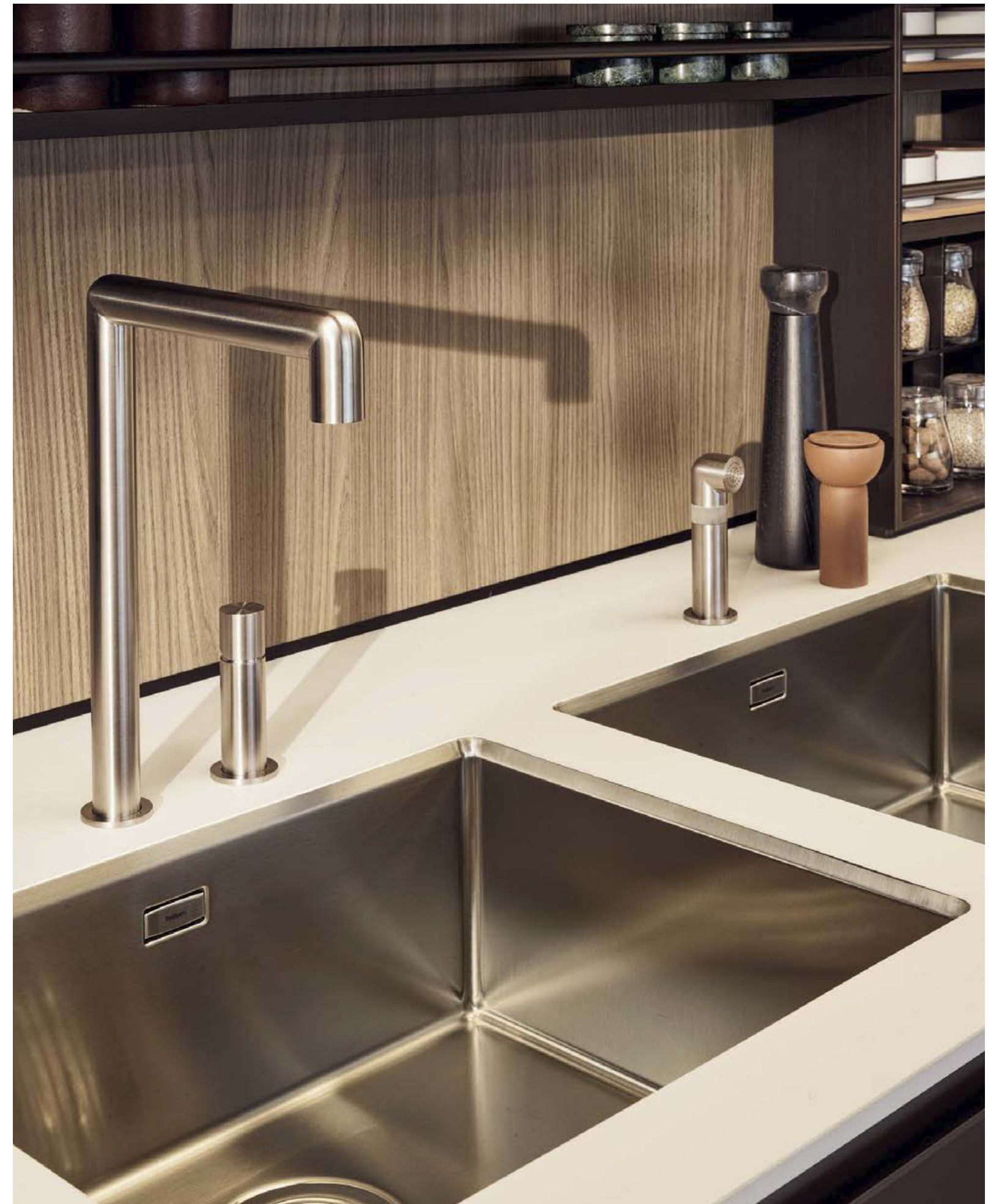



Nella pagina precedente: isola centrale con ante in LCT super white, piano a sbalzo Planar in Inalco MDi® calacatta oro touch. Sgabello Ventura in olmo nero e pelle non sfoderabile Silk 10 terracotta. Basi a parete in STM champagne con top e fianchi di finitura in laminato tuttocolore touch super white, piani cottura a induzione e a gas Pitt Cooking® con manopola personalizzata Poliform. Sistema modulare Infinity personalizzato Poliform con modulo aspirante luminoso in acciaio scotch brite. A destra: dettaglio del piano a sbalzo Planar in Inalco MDi® calacatta oro touch con gola in anodizzato champagne e fianco interno Ala in laccato opaco champagne.

Previous page: central unit with doors in LCT super white, jutting-out top Planar in Inalco MDi® calacatta oro touch. Ventura stool in black elm and non-removable leather Silk 10 terracotta. Wall base units in STM champagne with top and finishing sides in laminate tuttocolore touch super white, induction and gas hobs Pitt Cooking® with Poliform personalized control knob. Poliform personalized modular system Infinity with lighted extractor module in steel scotch brite. Right: close-up of the jutting-out top Planar in Inalco MDi® calacatta oro touch with channel in anodized champagne and inner side Ala in champagne mat lacquer.





A sinistra: dettaglio degli estrattori con cassetti interni in alluminio anodizzato naturale, attrezzatura in noce canaletto e alluminio anodizzato moka.

Left: close-up of the pull-out baskets with inner drawers in natural anodized aluminium, equipment in walnut canaletto and moka anodized aluminium.

In questa pagina: colonne con ante ed estrattori in STM champagne con profilo maniglia, gola orizzontale e verticale in anodizzato champagne. Isola centrale con ante in LCT super white con profilo maniglia e gola in anodizzato champagne, top in Inalco MDi® calacatta oro touch.

This page: tall units with doors and pull-out baskets in STM champagne with handle profile, horizontal and vertical channel in anodized champagne. Central island with doors in LCT super white with handle profile and channel in anodized champagne, top in Inalco MDi® calacatta oro touch.





A sinistra: dettaglio della colonna Convoy Centro con struttura estraibile verniciata brown e interno in nobilitato grigio perla, ante in STM champagne con profilo maniglia e gola in anodizzato champagne.

Left: close-up of the tall unit Convoy Centro with painted brown pull-out structure and interior in grey perla melamine, doors in STM champagne with handle profile and channel in anodized champagne.

A destra: dettaglio dell'anta in LCT super white con profilo maniglia, gola orizzontale e verticale terminale in anodizzato champagne. Top e fianchi di finitura in Inalco MDi® calacatta oro touch.

Right: close-up of the door in LCT super white with handle profile, horizontal and lateral vertical channel in anodized champagne. Top and finishing sides in Inalco MDi® calacatta oro touch.

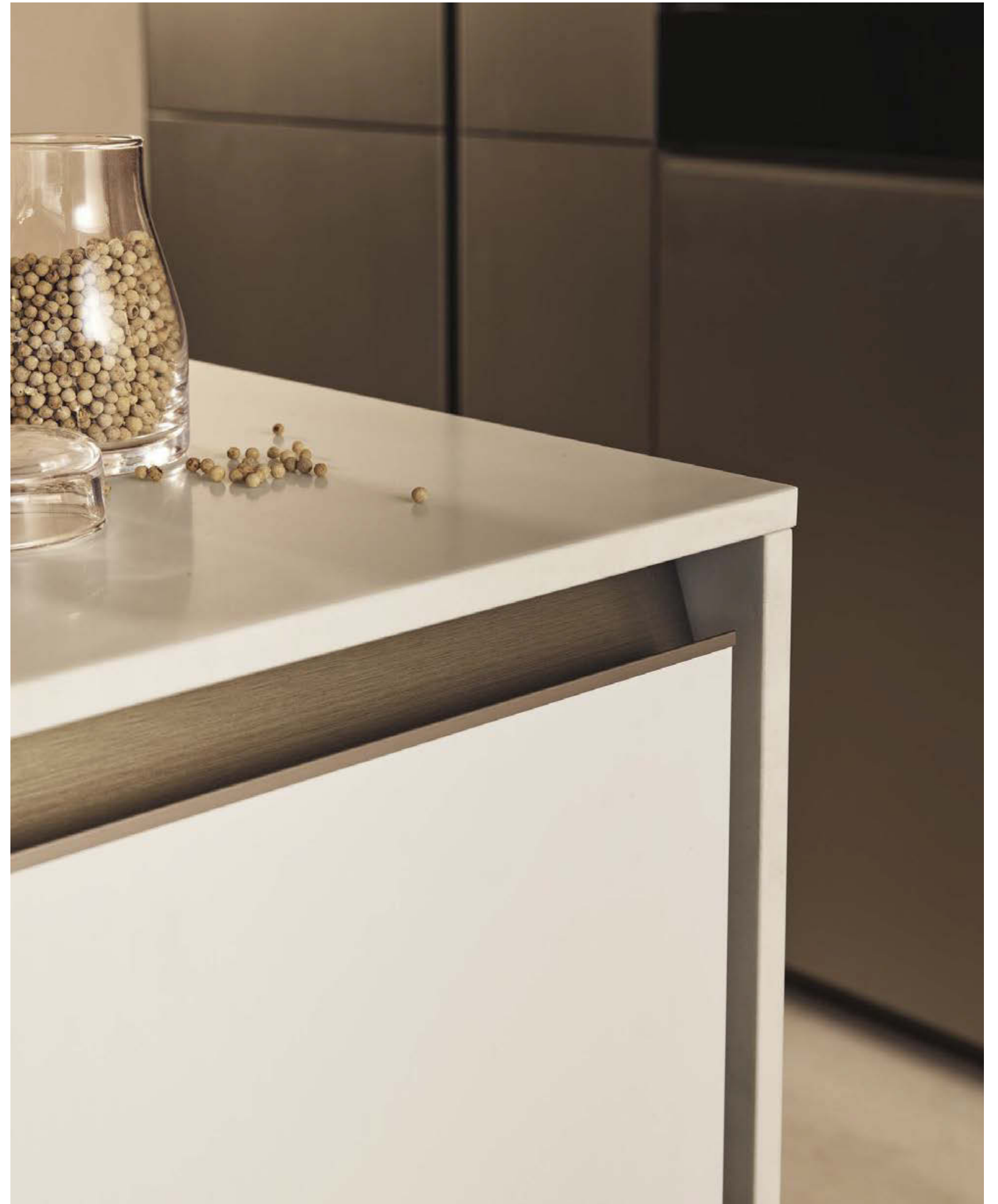

ALEA PRO
Design R&D Poliform

**Basi - isola p 737/1044,
a parete p 737**

Strutture: nobilitato grigio perla.
Isola: ante LCT super white; top, piano a sbalzo Planar e fianchi: Inalco MDi® calacatta oro touch, spessore 12 mm.
A parete: ante STM champagne; top e fianchi: laminato tuttocolore touch super white, spessore 12 mm.
Profili maniglia, gole orizzontali e verticali: anodizzato champagne.
Zoccoli: laccato opaco champagne.

Sistema modulare Infinity

Modulo aspirante luminoso e due moduli luminosi.
Finitura acciaio scotch brite e vetro extralight.

Pensili vetrina PR24 p 410

Strutture: nobilitato olmo smoke.
Ante vetrina PR24: profilo anodizzato champagne e vetro riflettente fumé.
Fianchi di finitura: STM champagne, spessore 6 mm.

Deep Shaker p 160

Struttura: anodizzato moka.
Schienale: nobilitato olmo smoke.
Ante a ribalta, tubi: laccato gofrato moka.

Colonne p 640

Strutture: nobilitato grigio perla.
Ante: STM champagne, profilo maniglia e gola orizzontale anodizzato champagne.
Gole verticali: anodizzato champagne.

Complementi

Sgabello Ventura: olmo nero, pelle non sfoderabile Silk 10 terracotta.

**Base units - island d 29"/41",
to the wall d 29"**

Structures: grey perla melamine.
Island: doors LCT super white; top, jutting-out top Planar and sides: Inalco MDi® calacatta oro touch, thickness 1/2".
To the wall: doors STM champagne; top and sides: laminate tuttocolore touch super white, thickness 1/2".
Handle profiles, horizontal and vertical channels: anodized champagne.
Plinths: champagne mat lacquer.

Modular system Infinity

Lighted extractor module and two lighted modules.
Finishing steel scotch brite and extra light glass.

Showcase wall units PR24 d 16 1/4"

Structures: smoke elm melamine.
Showcase doors PR24: profile anodized champagne and fumé reflective glass.
Finishing sides: STM champagne, thickness 1/4".

Deep Shaker d 6 1/4"

Structure: anodized moka.
Back: smoke elm melamine.
Flap door, bars: moka embossed lacquer.

Tall units d 25 1/4"

Structures: grey perla melamine.
Doors: STM champagne, handle profile and horizontal channel anodized champagne.
Vertical channels: anodized champagne.

Accessories

Ventura stool: black elm, non-removable leather Silk 10 terracotta.

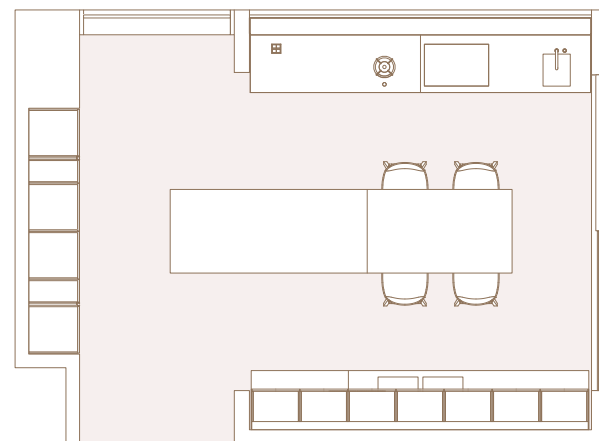
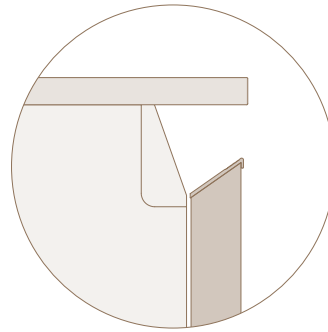

**Isola
Island**

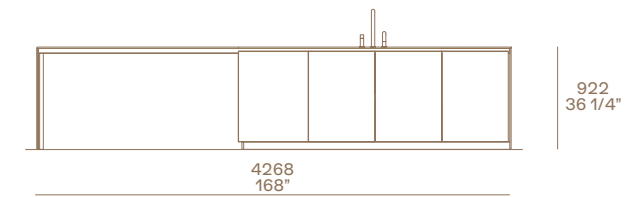
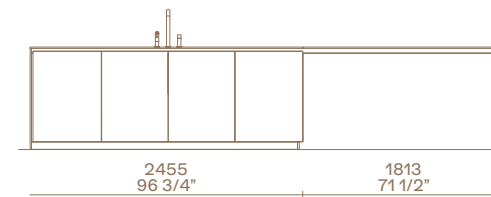

**Basi a parete
Wall base units**

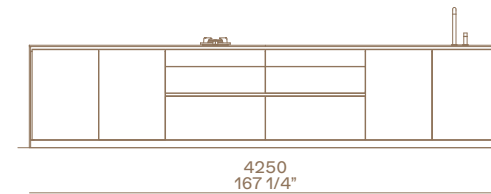

**Basi a parete, pensili, Deep Shaker
Wall base units, wall units, Deep Shaker**

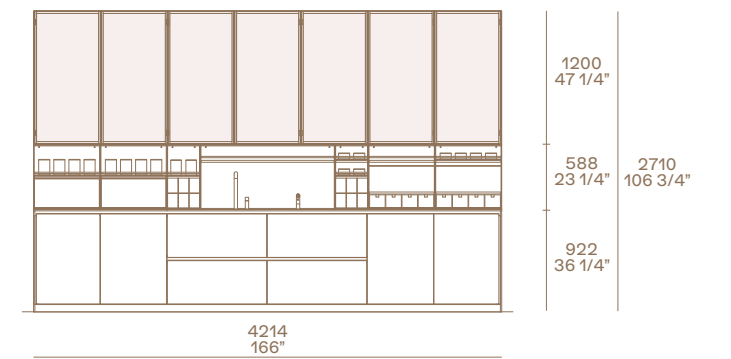

**Colonne
Tall units**

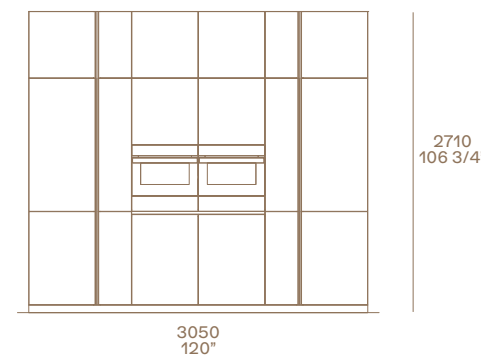

**Ventura
Design Jean-Marie Massaud**

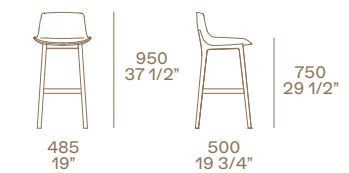

- 1 Sistema modulare Infinity, personalizzato Poliform.
- 2 Presa elettrica a scomparsa.
- 3 Piano cottura a gas Pitt Cooking® con manopola personalizzata Poliform.
- 4 Piano cottura a induzione, incasso filotop.
- 5 Lavelli integrati in acciaio per piani in laminato tuttocolore.

- 6 Attrezzatura in noce canaletto e alluminio anodizzato moka.
- 7 Piano a sbalzo Planar, 1813×1044 mm.
- 8 Fianco Ala.
- 9 Pensili con ante vetrina PR24, apertura con profilo inferiore, ripiani in vetro fumé con telaio anodizzato nero.

- 10 Schienale modulare Deep Shaker con configurazione a ponte in corrispondenza dei livelli.
- 11 Colonne con forni e frigoriferi con ante ad apertura battente ed estrattori.
- 12 Colonna Convoy Centro con struttura estraibile.

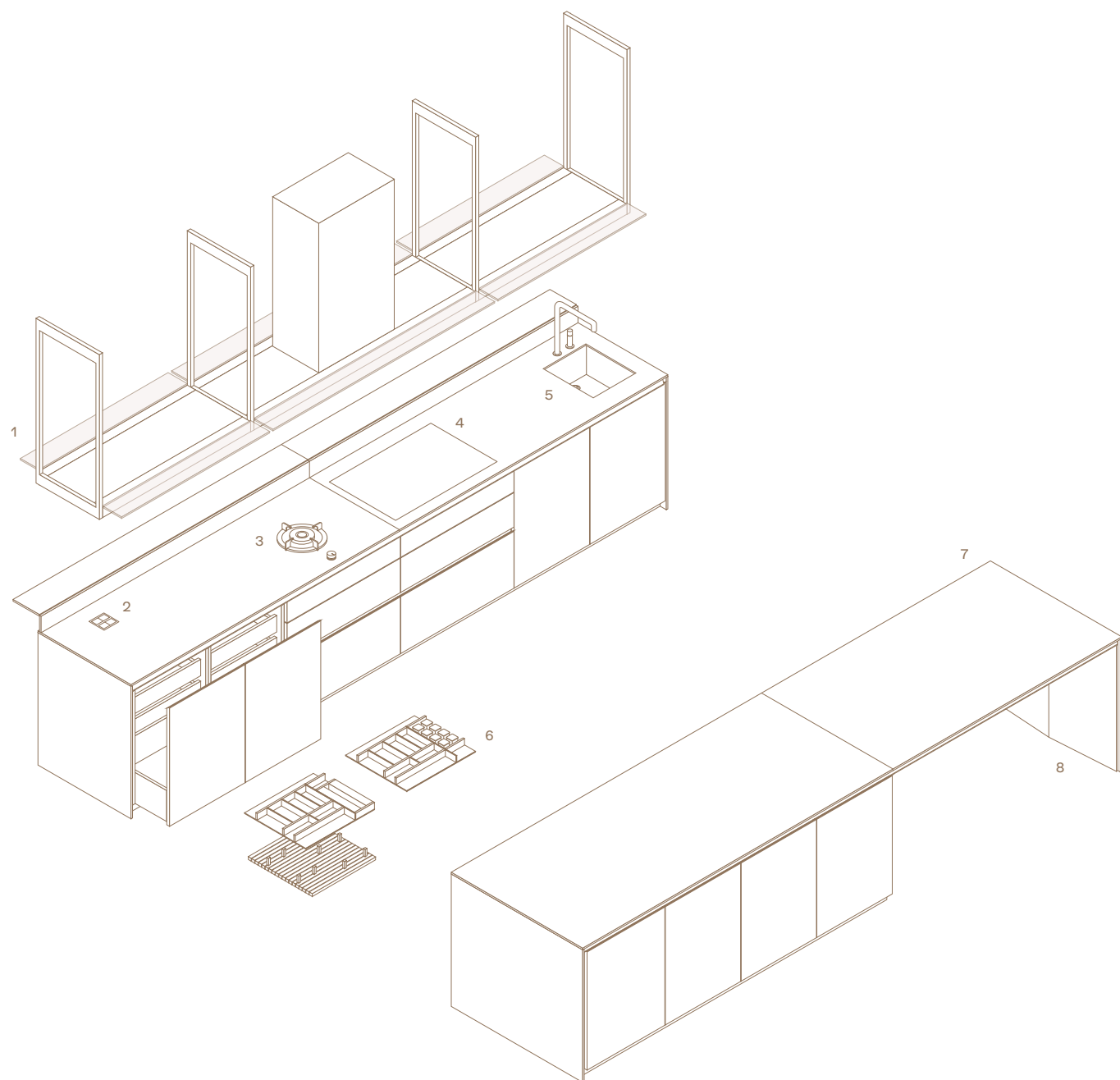

- 1 Modular system Infinity, personalized Poliform.
- 2 Retractable electrical socket.
- 3 Gas hob Pitt Cooking® with Poliform personalized control.
- 4 Induction hob, flush built-in.
- 5 Integrated sinks in steel for tops in laminated all-color.

- 6 Equipment in walnut canaletto and moka anodized aluminium.
- 7 Jutting-out top Planar, 71 1/2"x41".
- 8 Side Ala.
- 9 Wall units with showcase doors PR24, opening with lower profile, shelves in fumé glass with anodized black frame.

- 10 Modular back Deep Shaker with bridge configuration in correspondence of the sinks.
- 11 Tall units with ovens and refrigerators with leaf doors and pull-out storage baskets.
- 12 Tall unit Convoy Centro with pull-out structure.

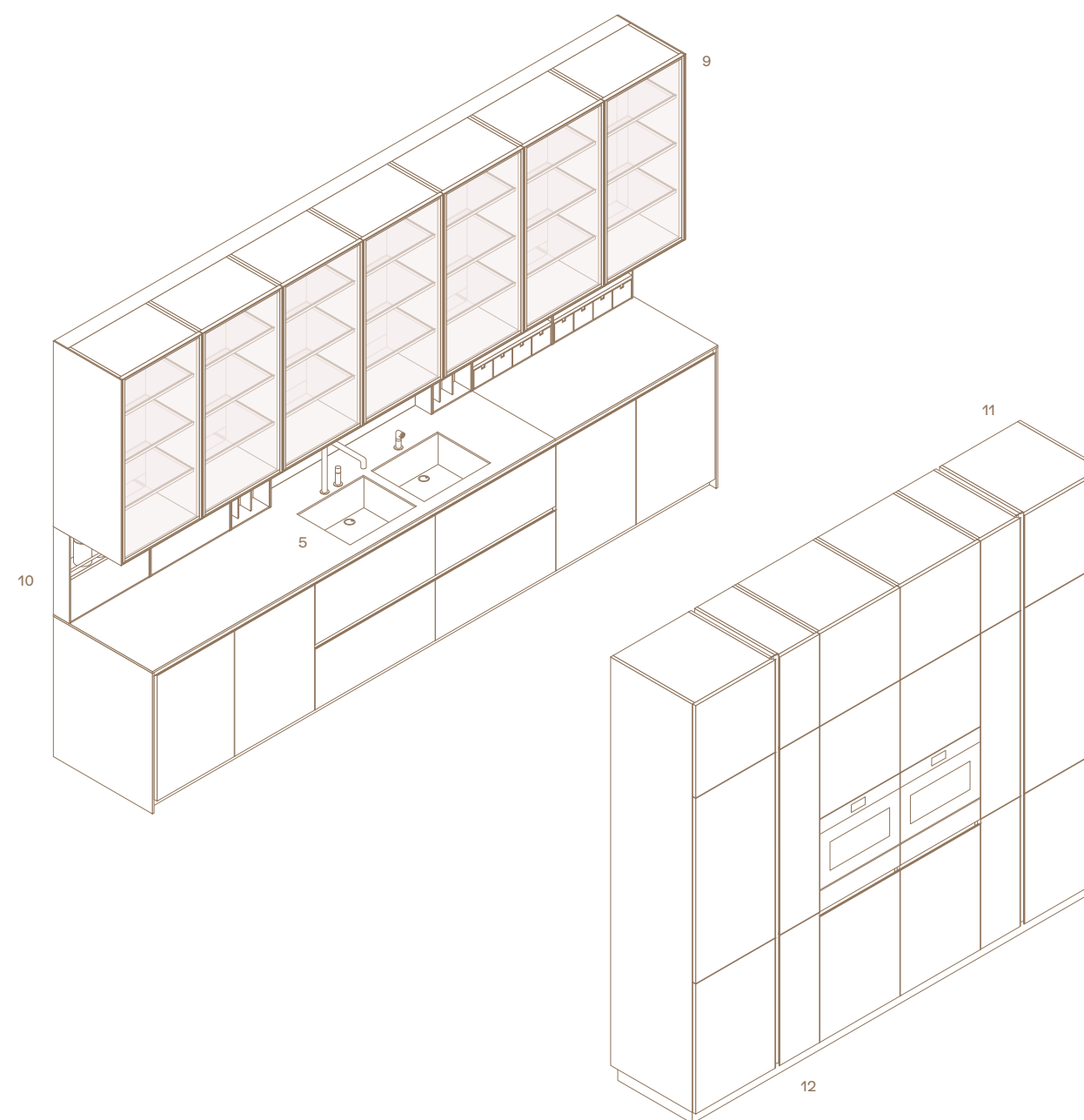

Qui e nella pagina successiva: basi con ante ed estrattori in rovere gold con profilo maniglia e gola in anodizzato moka, fianchi di finitura in rovere gold e top in laminato tuttocolore touch acciaio. In appoggio sulle basi, snack Lama con piano in olmo nero, gamba e supporto in laccato goffrato moka. Sgabelli Sophie Lite in olmo nero con poggiatesta in brown nickel opaco e seduta rivestita in tessuto sfoderabile Arcadia 05 bronzo. Pensili con ante in LCT silver gray. Sotto ai pensili, Deep Shaker in anodizzato moka e schienali in rovere gold con configurazione a ponte per elettrodomestici. Colonne con ante ed estrattori in LCT silver gray con profilo maniglia e gola in anodizzato moka, ante vetrina PR24 in anodizzato moka e vetro riflettente fumé con struttura in rovere gold e illuminazione a led integrata.

This and next page: base units with doors and pull-out baskets in gold oak with handle profile and channel in anodized moka, finishing sides in gold oak and top in laminate tuttocolore touch acciaio. On the base units, snack Lama with top in black elm, leg and support in moka embossed lacquer. Sophie Lite stools in black elm with footrest in mat brown nickel and seat covered in removable fabric Arcadia 05 bronze. Wall units with doors in LCT silver gray. Under the wall units, Deep Shaker in anodized moka and backs in gold oak with bridge configuration for electrical appliances. Tall units with doors and pull out baskets in LCT silver gray with handle profile and channel in anodized moka, showcase doors PR24 in anodized moka and fumé reflective glass with structure in gold oak and integrated led lighting.





In questa pagina: basi con ante ed estrattori in rovere gold con profilo maniglia e gola in anodizzato moka, fianchi di finitura in rovere gold e top in laminato tuttocolore touch acciaio. Pensili con ante in LCT silver gray. Sotto ai pensili, Deep Shaker in anodizzato moka e schienali in rovere gold con configurazione a ponte per elettrodomestici. Tavolino Dama in massello noce canaletto.

This page: base units with doors and pull-out baskets in gold oak with handle profile and channel in anodized moka, finishing sides in gold oak and top in laminate tuttocolore touch acciaio. Wall units with doors in LCT silver gray. Under the wall units, Deep Shaker in anodized moka and backs in gold oak with bridge configuration for electrical appliances. Dama coffee table in solid walnut canaletto.





A sinistra: dettaglio del top con lavello integrato in laminato tuttocolore touch acciaio. Piano cottura a induzione con cappa a scomparsa Fly personalizzata Poliform e pannello sottopensile in laccato goffrato silver gray con canalina multiled posteriore.

Left: close-up of the top with integrated sink in laminate tuttocolore touch acciaio. Induction hob with Fly built-in hood personalized Poliform and panel under wall unit in silver gray embossed lacquer with rear multiled channel.

A destra: dettaglio della base con top in laminato tuttocolore touch acciaio, anta in rovere gold con profilo maniglia e gola in anodizzato moka, fianco di finitura in rovere gold.

Right: close-up of the base unit with top in laminate tuttocolore touch acciaio, door in gold oak with handle profile and channel in anodized moka, finishing side in gold oak.





A sinistra: dettaglio dei cesti estraibili LeMans II in verniciato brown per base ad angolo, ante in rovere gold con profilo maniglia e gola in anodizzato moka, top in laminato tuttocolore touch acciaio. Nella pagina successiva: pensili con ante in LCT silver gray. Sotto ai pensili, Deep Shaker in anodizzato moka con configurazione a ponte per elettrodomestici, schienali in rovere gold, tubi in acciaio scotch brite, porta tablet, porta coltelli e cassettoni in noce canaletto, barattoli in ceramica e vetro con coperchi noce canaletto.

Left: close-up of the pull-out trays LeMans II in painted brown for corner base units, doors in gold oak with handle profile and channel in anodized moka, top in laminate tuttocolore touch acciaio. Next page: wall units with doors in LCT silver gray. Under the wall units, Deep Shaker in anodized moka with bridge configuration foreseen for electrical appliances, backs in gold oak, bars in scotch brite steel, tablet holder, knife holder and small drawers in walnut canaletto, ceramic and glass jars with walnut canaletto lids.



A destra: dettaglio del lavello integrato al top in laminato tuttocolore touch acciaio, ante in rovere gold con profilo maniglia e gola in anodizzato moka.

Right: close-up of the sink integrated in the top in laminate tuttocolore touch acciaio, doors in gold oak with handle profile and channel in anodized moka.





Qui e nella pagina successiva: basi con ante ed estrattori in rovere gold, profilo maniglia e gola in anodizzato moka, cassetto interno in alluminio anodizzato naturale con attrezzatura in laminato military touch. Top in laminato tuttocolore touch acciaio. Piano cottura a induzione. Deep Shaker in anodizzato moka con configurazione a ponte per elettrodomestici, schienali in rovere gold, tubi in acciaio scotch brite, porta tablet, porta coltelli e cassettoni in noce canaletto, barattoli in ceramica e vetro con coperchi noce canaletto. Pensili con ante in LCT silver gray. Nella successiva: in appoggio sulle basi, snack Lama con piano in olmo nero, gamba e supporto in laccato goffrato moka. Sgabelli Sophie Lite in olmo nero con poggiatesta in brown nickel opaco e seduta rivestita in tessuto sfoderabile Arcadia 05 bronzo.

This and following page: base units with doors and pull-out baskets in gold oak, handle profile and channel in anodized moka, inner drawer in natural anodized aluminium with equipment in laminate military touch. Top in laminate tuttocolore touch acciaio. Induction hob. Deep Shaker in anodized moka with bridge configuration for electrical appliances, backs in gold oak, bars in scotch brite steel, tablet holder, knife holder and small drawers in walnut canaletto, ceramic and glass jars with walnut canaletto lids. Wall units with doors in LCT silver gray. Next page: on the base units, snack Lama with top in black elm, leg and support in moka embossed lacquer. Sophie Lite stools in black elm with footrest in mat brown nickel and seat covered in removable fabric Arcadia 05 bronze.



In questa pagina: colonne con ante ed estrattori in LCT silver gray con profilo maniglia e gola in anodizzato moka. Ante vetrina PR24 in anodizzato moka e vetro riflettente fumé con struttura interna in rovere gold, ripiani in vetro fumé con telaio in anodizzato nero e illuminazione a led integrata. Sgabello Sophie Lite in olmo nero con poggiatesta in brown nickel opaco e seduta rivestita in tessuto sfoderabile Arcadia 05 bronzo.

This page: tall units with doors and pull-out baskets in LCT silver gray with handle profile and channel in anodized moka. Showcase doors PR24 in anodized moka and fumé reflective glass with inner structure in gold oak, shelves in fumé glass with frame in anodized black and integrated led lighting. Sophie Lite stool in black elm with footrest in mat brown nickel and seat covered in removable fabric Arcadia 05 bronze.





A sinistra: dettaglio della colonna con interno in rovere gold, attrezzato con cassettera in laminato opaco touch nero, ripiani in vetro fumé con telaio in anodizzato nero e illuminazione a led integrata.

Left: close-up of the tall unit with interior in gold oak, equipped with chest of drawers in mat laminate touch nero, shelves in fumé glass with anodized black frame and integrated led light.

A destra: dettaglio dell'anta vetrina PR24 in anodizzato moka e vetro riflettente fumé con maniglia integrata nel montante del telaio.

Right: close-up of the showcase door PR24 in anodized moka and fumé reflective glass with integrated handle in the vertical frame.





A sinistra: snack Lama con piano in olmo nero, gamba e supporto in laccato goffrato moka. Sgabelli Sophie Lite in olmo nero con poggiatesta in brown nickel opaco e seduta rivestita in tessuto sfoderabile Arcadia 05 bronzo.

Left: snack Lama with top in black elm, leg and support in moka embossed lacquer. Sophie Lite stools in black elm with footrest in mat brown nickel and seat covered in removable fabric Arcadia 05 bronze.

ALEA PRO

Design R&D Poliform

Basi p 737

Strutture: nobilitato grigio perla.
 Ante: rovere gold, profilo maniglia e gola anodizzato moka.
 Top: laminato tuttocolore touch acciaio, spessore 20 mm.
 Fianchi di finitura: rovere gold, spessore 20 mm.
 Zoccoli: laccato goffrato moka.

Snack Lama Ø 1400

Piano olmo nero, gamba e supporto in laccato goffrato moka.

Pensili p 410

Strutture: nobilitato grigio perla.
 Ante: LCT silver gray.
 Fianchi di finitura: laccato goffrato silver gray, spessore 6 mm.

Deep Shaker p 160

Strutture: anodizzato moka.
 Schienale: rovere gold.
 Tubi: acciaio scotch brite.

Colonne p 640

Strutture: nobilitato grigio perla.
 Ante: LCT silver gray, profilo maniglia e gola anodizzato moka.
 Strutture vetrina: rovere gold.
 Ante vetrina PR24: profilo anodizzato moka e vetro riflettente fumé.

Complementi

Sgaballo Sophie Lite: olmo nero, tessuto sfoderabile Arcadia 05 bronzo.

Base units d 29"

Structures: grey perla melamine.
 Doors: gold oak, handle profile and channel anodized moka.
 Top: laminate tuttocolore touch acciaio, thickness 3/4".
 Finishing sides: gold oak, thickness 3/4".
 Plinths: moka embossed lacquer.

Lama snack Ø 55"

Black elm top, leg and support in moka embossed lacquer.

Wall units d 16 1/4"

Structures: grey perla melamine.
 Doors: LCT silver gray.
 Finishing sides: silver gray embossed lacquer, thickness 1/4".

Deep Shaker d 6 1/4"

Structures: anodized moka.
 Back: gold oak.
 Bars: steel scotch brite.

Tall units d 25 1/4"

Structures: grey perla melamine.
 Doors: LCT silver gray, handle profile and channel anodized moka.
 Showcase structures: gold oak.
 Showcase doors PR24: anodized moka profile and fumé reflective glass.

Accessories

Sophie Lite stool: black elm, removable fabric Arcadia 05 bronzo.

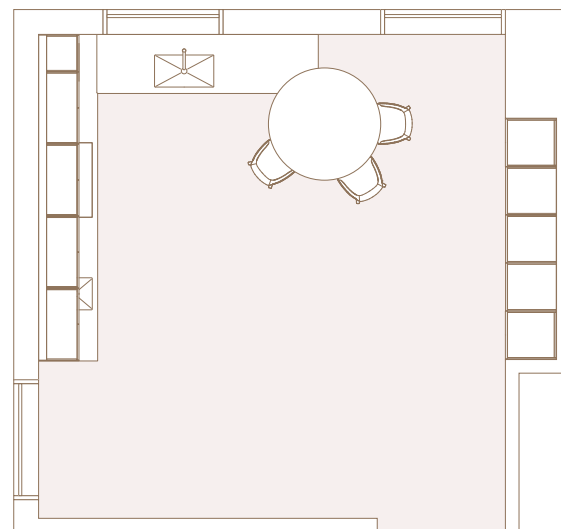
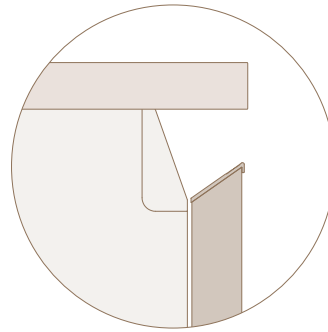

Basi, pensili, Deep Shaker Base units, wall units, Deep Shaker

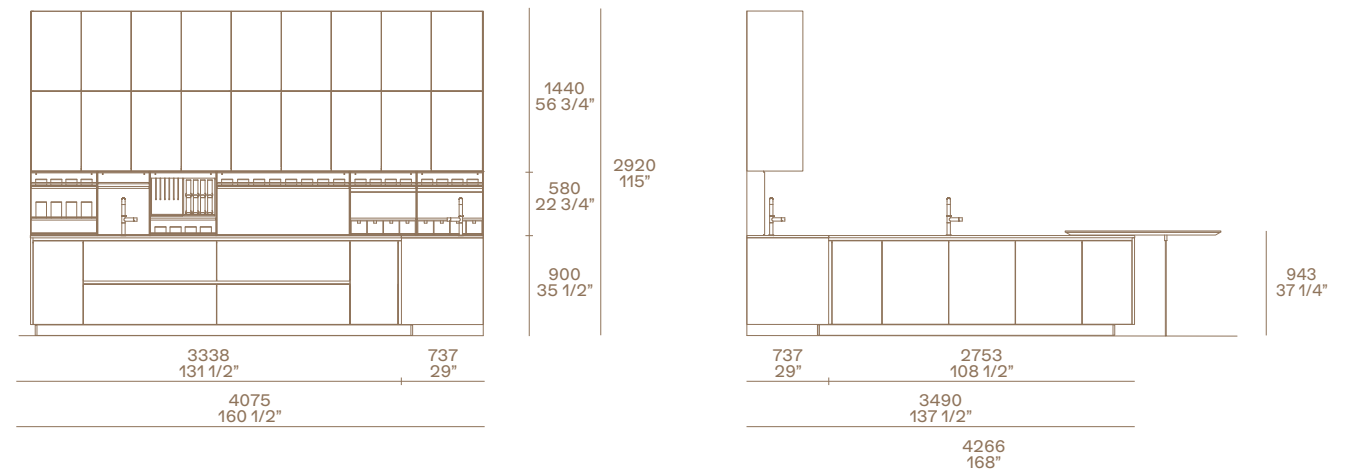

Colonne Tall units

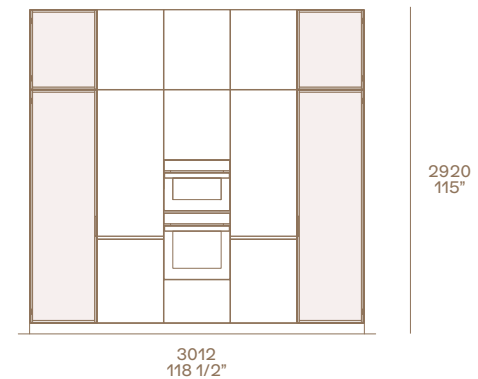

Sophie Lite Design Emmanuel Gallina

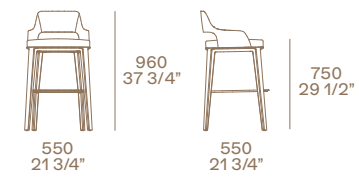

- 1 Pensili con ante battenti, apertura tip-on e con profilo inferiore.
- 2 Cappa a scomparsa Fly, personalizzata Poliform.
- 3 Schienale modulare Deep Shaker con configurazioni a ponte in corrispondenza del lavello e del piano cottura.

- 4 Lavelli integrati in laminato tuttocolore touch acciaio con fondo in acciaio.
- 5 Piano cottura a induzione, incasso filotop.
- 6 Attrezzatura cassette in laminato military touch.
- 7 Presa elettrica a scomparsa.

- 8 Snack Lama, \varnothing 1400 mm.
- 9 Colonne con ante vetrina PR24, cassetiera in laminato opaco touch nero, ripiani in vetro fumé con telaio in anodizzato nero.
- 10 Colonne con forni e frigoriferi con ante ad apertura battente ed estrattori.

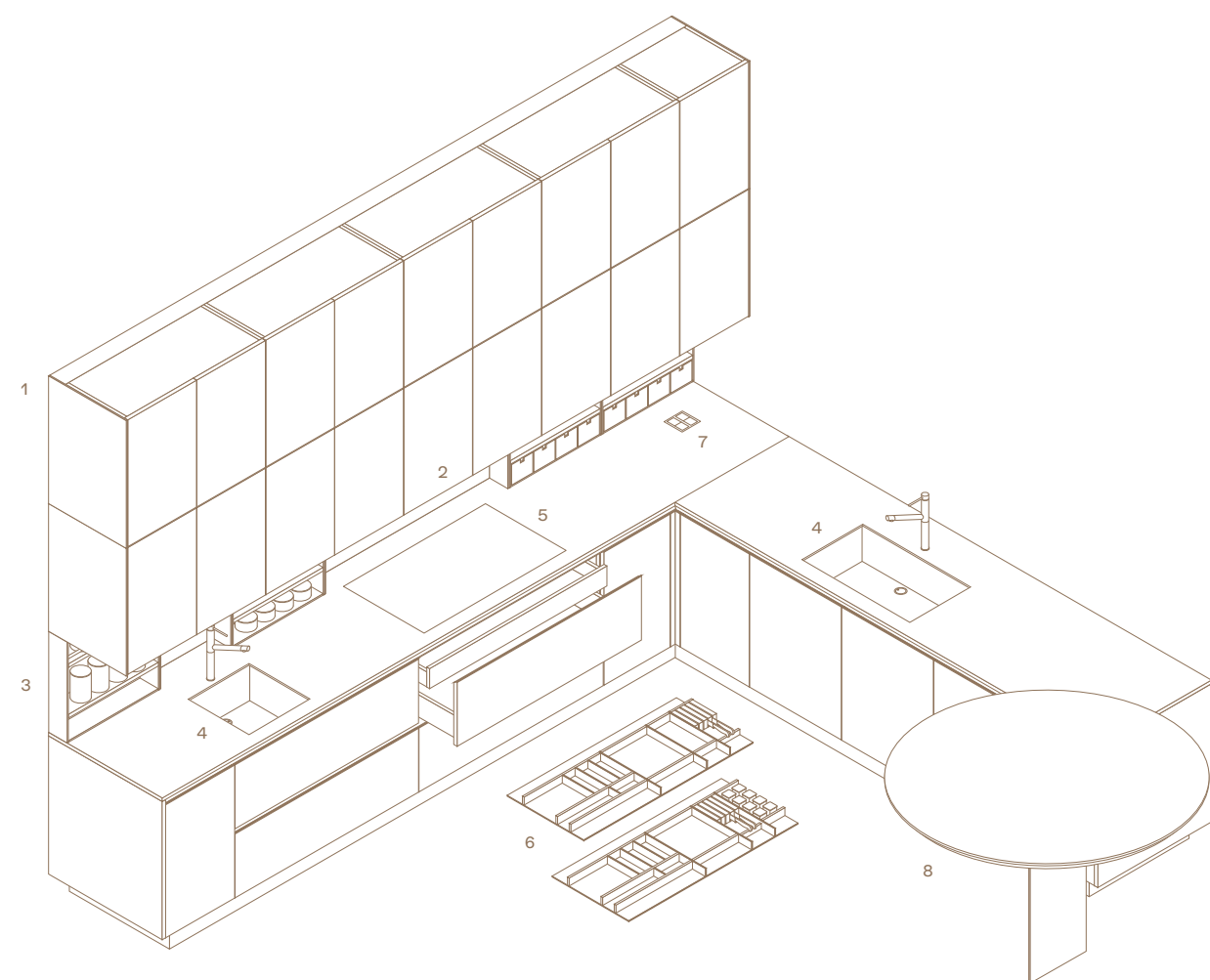

- 1 Wall units with leaf doors, opening with tip-on and with lower profile.
- 2 Fly built-in hood, personalized Poliform.
- 3 Modular back Deep Shaker with bridge configurations in correspondence of the sink and the hob.

- 4 Integrated sinks in laminate tuttocolore touch acciaio with steel bottom.
- 5 Induction hob, flush built-in.
- 6 Drawers' equipment in laminate military touch.
- 7 Retractable electrical socket.

- 8 Snack Lama, diameter 55".
- 9 Tall units with glass doors PR24, chest of drawers in laminate mat touch nero, shelves in fumé glass with anodized black frame.
- 10 Tall units with ovens and refrigerators with leaf doors and pull-out baskets.

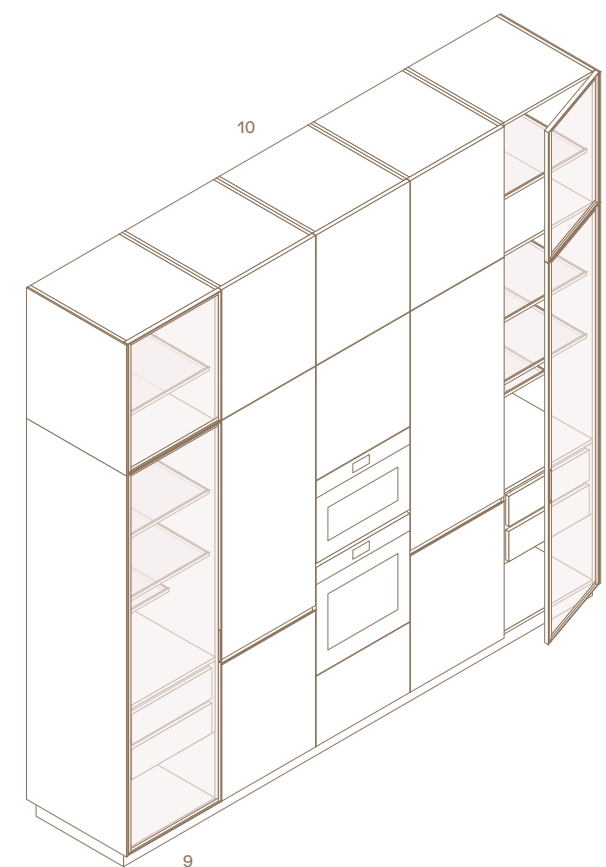

Qui e nella pagina successiva: basi con estrattori e ante in massello dogato noce c. con telaio di supporto, profilo maniglia e gola in anodizzato moka, piano e fianchi di finitura in Inalco MDi® nero. Piano attrezzato con Deep Shaker Island con moduli a terra e in appoggio al piano. Deep Shaker Island in anodizzato moka, tubi in anodizzato moka, piani e cassettini in noce canaletto e barattoli in vetro e ceramica, cappa integrata con vetro fumé. Sistema modulare Infinity personalizzato Poliform con modulo aspirante e moduli luminosi in acciaio scotch brite e vetro fumé. Boiserie in olmo nero. Snack Lama con piano in olmo nero, gamba e supporto in laccato goffrato moka. Sgabelli Seattle con seduta e gambe rivestite in cuoio non sfoderabile 03 grigio scuro, poggiatesta in cromo satinato.

This and next page: base units with pull-out baskets and doors in staved solid wood walnut c. with support frame, handle profile and channel in anodized moka, top and finishing sides in Inalco MDi® nero. Top equipped with Deep Shaker Island with modules on the floor and placed on the top. Deep Shaker Island in anodized moka, hanging bars in anodized moka, shelves and small drawers in walnut canaletto and glass and ceramic jars, integrated hood with fumé glass. Infinity modular system personalized Poliform with extractor module and lighted modules in scotch brite steel and fumé glass. Wall panelling in black elm. Lama snack top with top in black elm, moka embossed lacquered leg and support. Seattle stools with seat and legs covered in non-removable hide 03 grigio scuro, footrest in satin chrome.





Deep Shaker Island è un sistema bifacciale da utilizzare sull'isola per attrezzare il piano di lavoro. Può essere progettato liberamente, in appoggio al piano o a terra, con qualsiasi modello di cucina Poliform. A destra: Deep Shaker Island in anodizzato moka, cappa integrata con vetro fumé, tubi in anodizzato moka, piani e cassettini in noce canaletto e barattoli in vetro e ceramica.

Deep Shaker Island is a double-sided system to be used to equip the island worktop. It can be freely designed, resting on the top or on the floor, with any Poliform kitchen model. Right: Deep Shaker Island in anodized moka, integrated hood with fumé glass, hanging bars in anodized moka, shelves and small drawers in walnut canaletto and glass and ceramic jars.





Qui e nella pagina successiva: basi con estrattori e ante in massello dogato noce c. con telaio di supporto, profilo maniglia e gola in anodizzato moka, piano e fianchi di finitura in Inalco MDi® nero. Piano attrezzato con Deep Shaker Island con moduli a terra e in appoggio al piano. Deep Shaker Island in anodizzato moka, cappa integrata con vetro fumé, tubi in anodizzato moka, piani e cassettini in noce canaletto e barattoli in vetro e ceramica. Sistema modulare Infinity personalizzato Poliform con modulo aspirante e moduli luminosi in acciaio scotch brite e vetro fumé. Boiserie in olmo nero. Nella successiva: Snack Lama con piano in olmo nero, gamba e supporto in laccato gofrato moka. Sgabelli Seattle con seduta e gambe rivestite in cuoio non sfoderabile 03 grigio scuro, poggiatesta in cromo satinato.

This and next page: base units with pull-out baskets and doors in staved solid wood walnut c. with support frame, handle profile and channel in anodized moka, top and finishing sides in Inalco MDi® nero. Top equipped with Deep Shaker Island with modules on the floor and placed on the top. Deep Shaker Island in anodized moka, integrated hood with fumé glass, hanging bars in anodized moka, shelves and small drawers in walnut canaletto and glass and ceramic jars. Infinity modular system personalized Poliform with extractor module and lighted modules in scotch brite steel and fumé glass. Wall panelling in black elm. Next page: Lama snack with top in black elm, moka embossed lacquered leg and support. Seattle stools with seat and legs covered in non-removable hide 03 grigio scuro, footrest in satin chrome.



ALEA PRO
Design R&D Poliform

Basi p 1144-1274

Strutture: nobilitato grigio lavagna.
Ante ed estrattori: massello dogato noce c.,
telaio di supporto, profilo maniglia
e gola anodizzato moka.
Fianchi: Inalco MDi® nero, spessore 12 mm.
Top: Inalco MDi® nero, spessore 12 mm.
Zoccoli: laccato goffrato moka.

Deep Shaker Island p 186

Strutture: anodizzato moka.
Tubi: anodizzato moka.
Cappa integrata: vetro fumé.

Boiserie

Pannelli: olmo nero.

Snack Lama Ø 1400

Piano: olmo nero
Gamba e supporto: laccato goffrato
moka.

Complementi

Sgabello Seattle: cuoio non sfoderabile
03 grigio scuro.

Base units d 45"-50 1/4"

Structures: grey lavagna melamine.
Doors and pull-out storage baskets: staved
solid wood walnut c., support frame, handle
profile and channel anodized moka.
Sides: Inalco MDi® nero, thickness 1/2".
Top: Inalco MDi® nero, thickness 1/2".
Plinths: embossed lacquer moka.

Deep Shaker Island d 7 1/4"

Structures: anodized moka.
Bars: anodized moka.
Integrated hood: fumé glass.

Wall panelling

Panels: black elm.

Lama Snack Ø 55"

Top: black elm.
Leg and support: embossed lacquer
moka.

Accessories

Seattle stool: non-removable hide
03 grigio scuro.

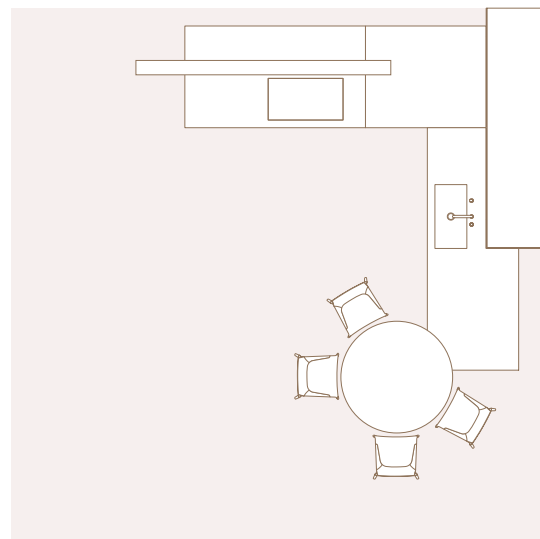
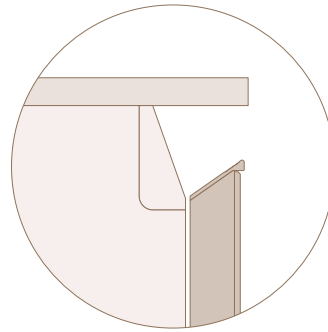

Basi, Deep Shaker Island
Base units, Deep Shaker Island

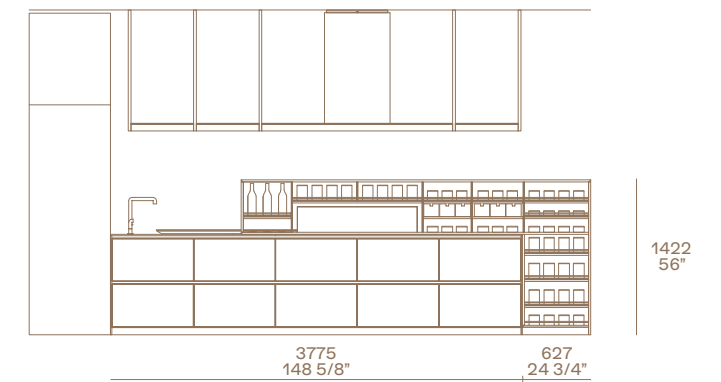
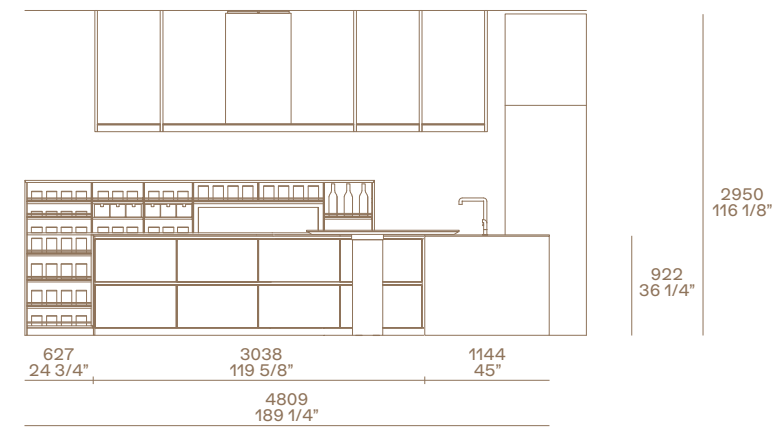

Basi, Deep Shaker Island, boiserie
Base units, Deep Shaker Island, wall panelling

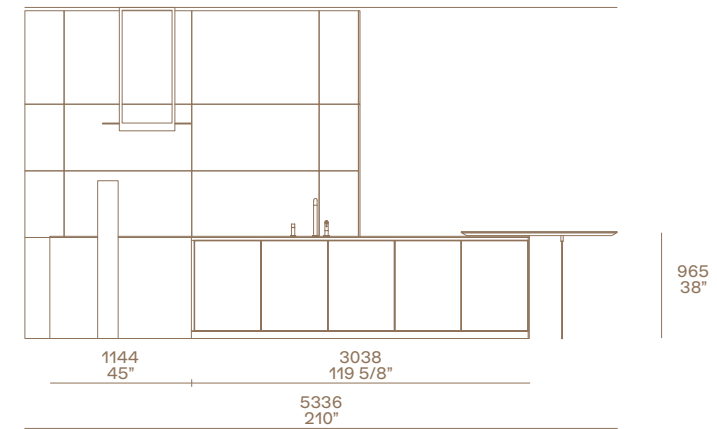

Seattle
Design Jean-Marie Massaud

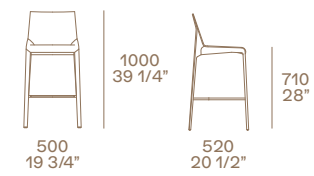

- 1 Basi con ante ed estrattori.
- 2 Deep Shaker Island con moduli sopratop e a terra, cappa integrata con vetro fumé in corrispondenza del piano cottura.
- 3 Piano cottura a induzione, incasso filotop.

- 4 Attrezzature in noce canaletto e alluminio anodizzato moka per cassetti interni ed estrattori.
- 5 Lavello integrato in Inalco MDi® nero con fondo in acciaio gun metal.

- 6 Sistema modulare Infinity personalizzato Poliform con modulo aspirante e moduli luminosi in acciaio scotch brite e vetro fumé.
- 7 Boiserie con pannelli spessore 12 mm.
- 8 Snack Lama, ø 1400 mm.

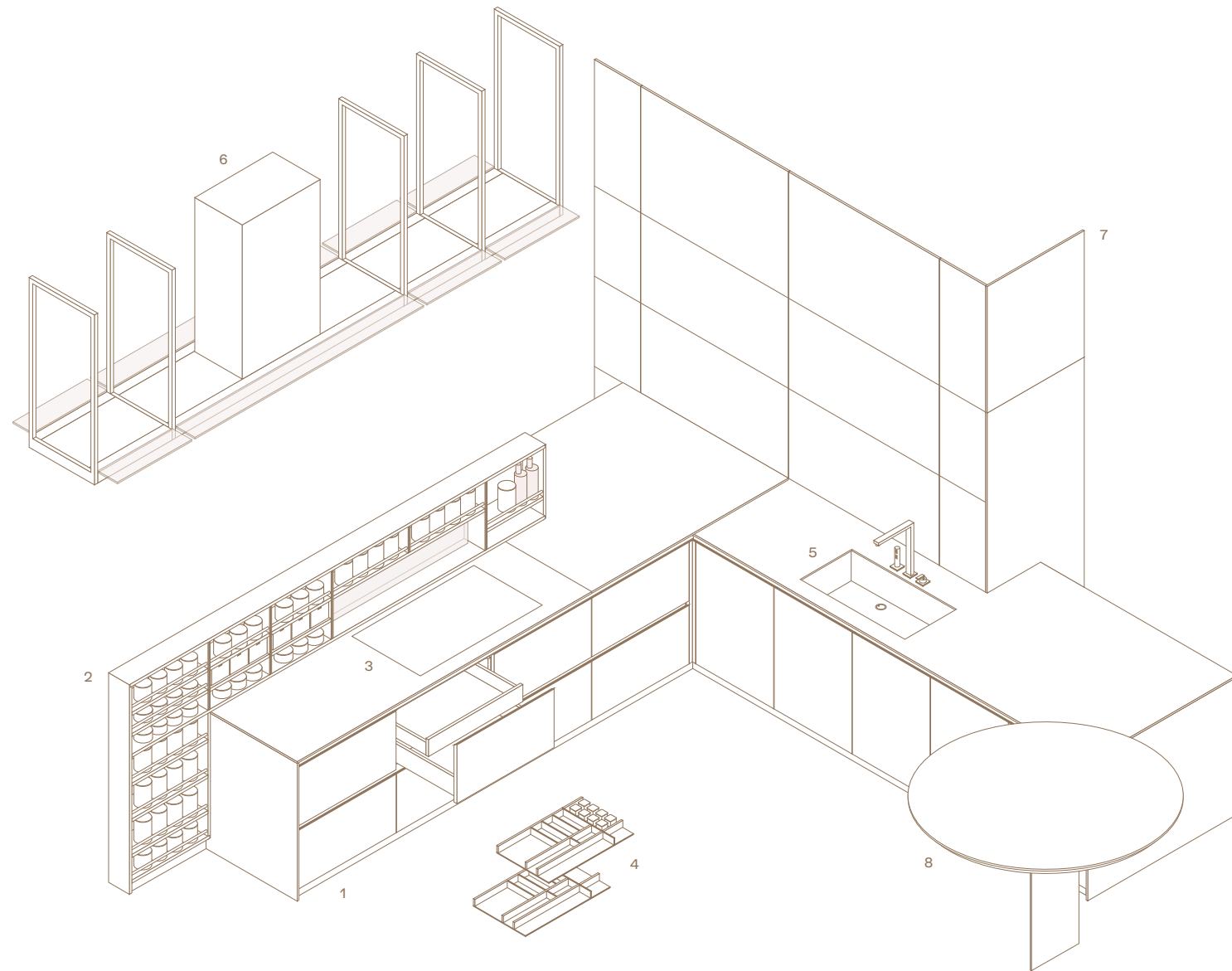

- 1 Base units with doors and pull-out storage baskets.
- 2 Deep Shaker Island with modules placed on the top and floorstanding, integrated hood with fumé glass by the hob.
- 3 Induction hob, fully flush built-in.

- 4 Equipment in walnut canaletto and moka anodized aluminium for inner drawers and pull-out baskets.
- 5 Integrated sink in Inalco MDi® nero with gun metal steel bottom.

- 6 Infinity modular system personalized Poliform with extractor module and lighted modules in scotch brite steel and fumé glass.
- 7 Wall panelling with panels thickness 1/2".
- 8 Lama snack, ø 55".

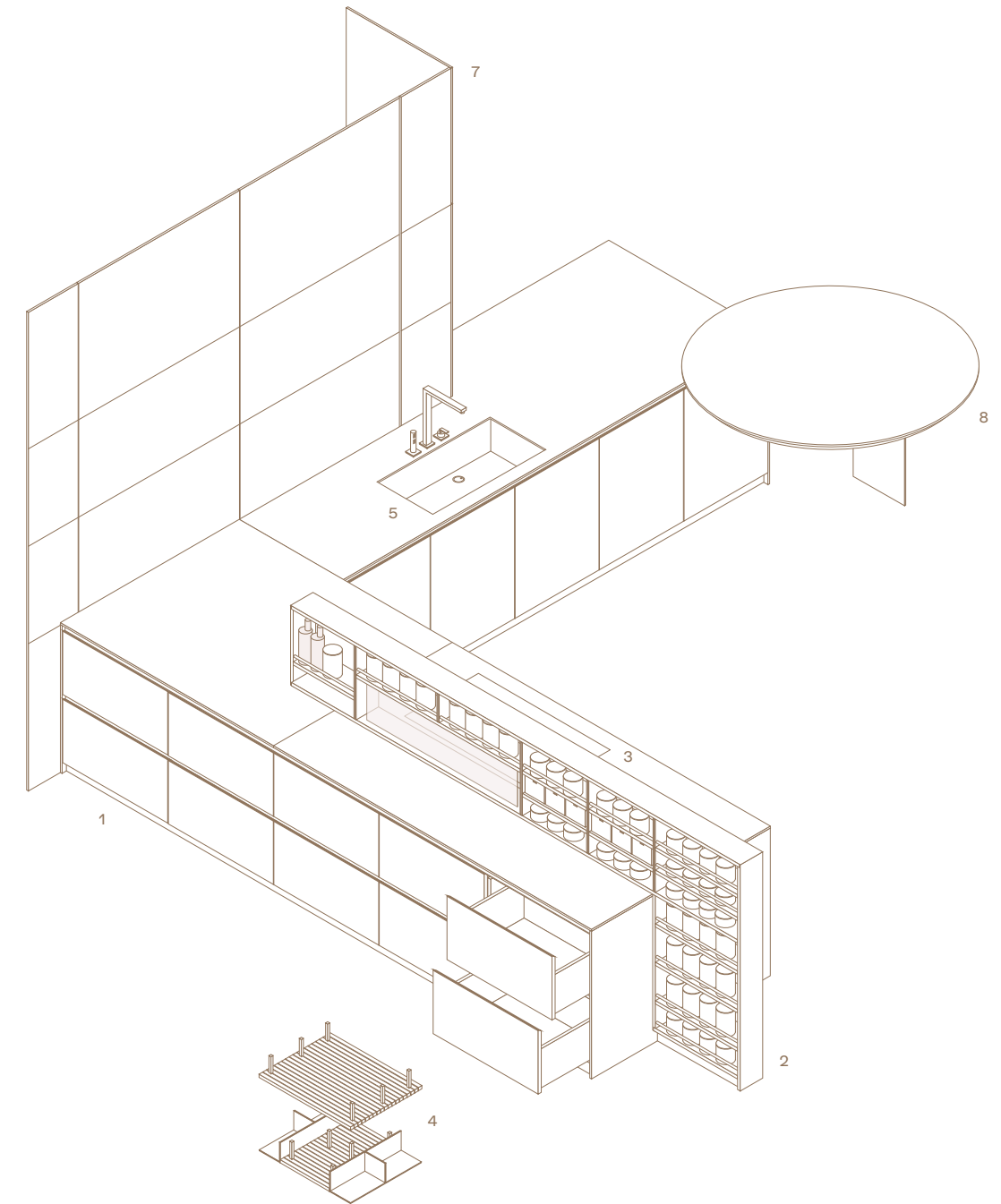

ALEA

Apertura a gola e massima versatilità nella scelta delle finiture: sono le caratteristiche che rendono l'anta Alea unica per possibilità compositive e personalizzazione. Un design lineare fatto di superfici piane e volumi geometrici, capace di ridefinire l'ambiente cucina unendo all'altissima capacità operativa un'estetica minimale.

Groove opening and maximum versatility in the choice of finishes: these are the characteristics that make the Alea door unique for compositional possibilities and customisation. A linear design made of flat surfaces and geometric volumes, capable of redefining the kitchen environment by combining a very high operational capability with a minimalistic style.

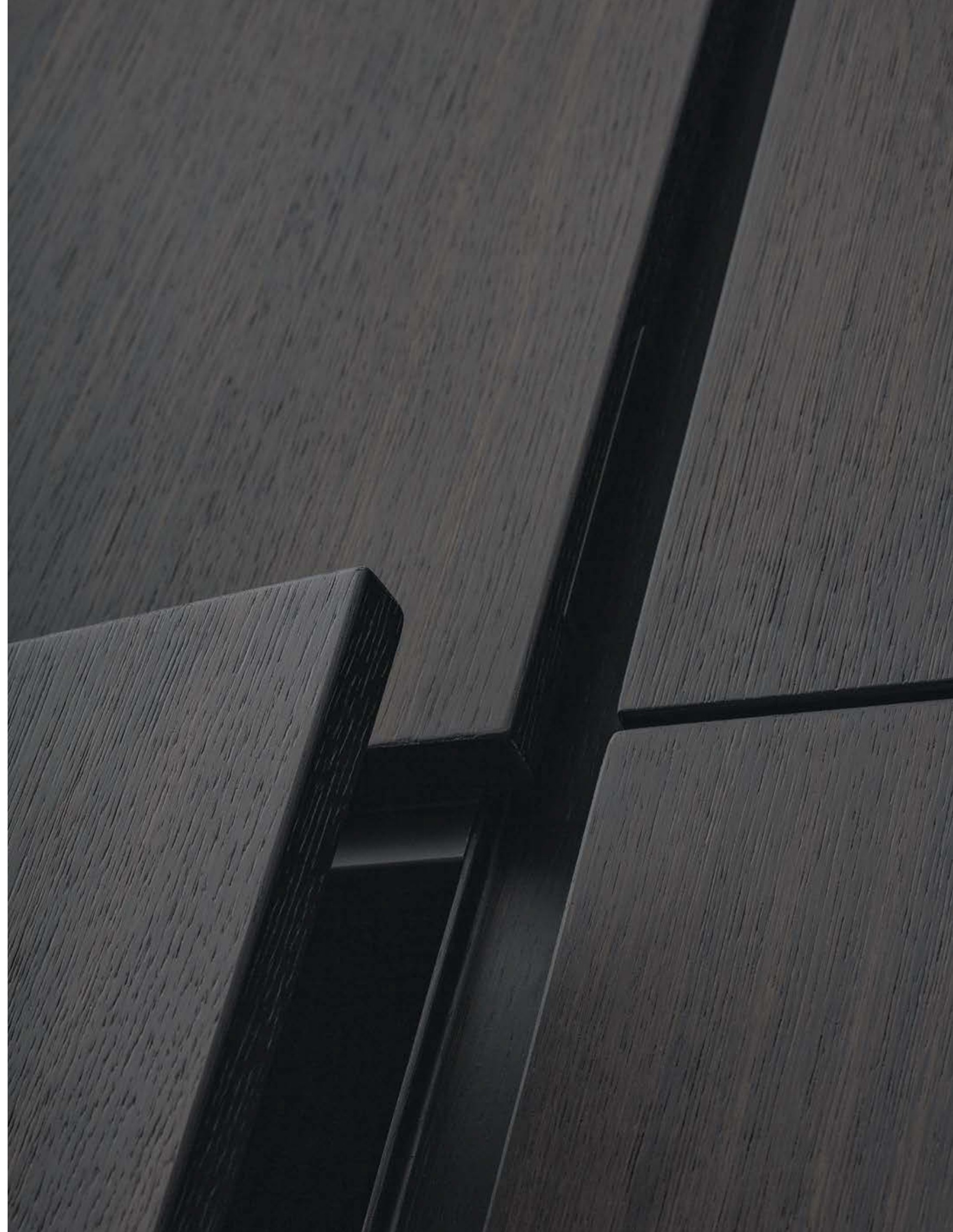



Qui e nella pagina precedente: basi e isola con ante, cassetti ed estrattori in laminato touch bianco e top in laminato tuttocolore touch bianco. Cappa Flat a isola in acciaio scotch brite personalizzata Poliform. Pensili e colonne con ante in laminato touch castoro. Mensola in laccato goffrato castoro con schienale in laminato tuttocolore touch castoro. Schienali in pietra fossena fiammata. Sgabelli Ventura in olmo nero e pelle Soft 14 oliva.

This and previous page: base units and island with doors, drawers and pull-out storage baskets in laminate touch bianco and top in laminate tuttocolore touch bianco. Poliform personalized island-hood Flat in scotch brite steel. Wall units and tall units with doors in laminate touch castoro. Castoro embossed lacquered shelf with back in laminate tuttocolore touch castoro. Backs in fossena stone blaze. Ventura stools in black elm and leather Soft 14 oliva.





A sinistra: isola con ante ed estrattori laminato touch bianco. Top in laminato tuttocolore touch bianco con lavello integrato. Piani cottura Miele Smart Line a induzione con piastra Teppan Yaki in acciaio e vetroceramica. Cappa Flat a isola in acciaio scotch brite personalizzata Poliform.

Left: island with doors and pull-out storage baskets laminate touch bianco. Worktop in laminate tuttocolore touch bianco with integrated sink. Induction hobs Miele Smart Line with Teppan Yaki griddle in steel and glass ceramics. Poliform personalized island-hood Flat in scotch brite steel.



Nella pagina precedente: basi e isola con ante, cassetti ed estrattori in laminato touch bianco e top in laminato tuttocolore touch bianco. Cappa Flat a isola in acciaio scotch brite personalizzata Poliform. Pensili e colonne con ante laminato touch castoro. Schienali in pietra fossena fiammata. Sgabelli Ventura in olmo nero e rivestimento in pelle Soft 14 oliva. A destra: estrattore con sistema di illuminazione interna a led. Cassetto interno verniciato brown e attrezzatura in noce canaletto e alluminio anodizzato moka.

Previous page: base units and island with doors, drawers and pull-out storage baskets in laminate touch bianco and top in laminate tuttocolore touch bianco. Poliform personalized island-hood Flat in scotch brite steel. Wall units and tall units with doors in laminate touch castoro. Backs in fossena stone blaze. Ventura stools in black elm and covering in leather Soft 14 oliva. Right: pull-out storage basket with brown painted inner drawer with inner led lighting system. Inner equipment in walnut canaletto and moka anodized aluminium.





Nella pagina successiva: basi e isola con ante, cassetti ed estrattori in laminato touch bianco e top in laminato tuttocolore touch bianco. Cappa Flat a isola in acciaio scotch brite personalizzata Poliform. Pensili e colonne con ante in laminato touch castoro. Mensola in laccato goffrato castoro con schienale in laminato tuttocolore touch castoro. Schienali in pietra fossena fiammata. Piano snack in rovere spessart. Sgabelli Ventura in olmo nero e pelle Soft 14 oliva. A sinistra: dettaglio dell'estrattore in laminato touch bianco, con piattaja e attrezzatura interna in noce canaletto e alluminio anodizzato moka.

Next page: base units and island with doors, drawers and pull-out storage baskets in laminate touch bianco and top in laminate tuttocolore touch bianco. Poliform personalized island-hood Flat in scotch brite steel. Wall units and tall units with doors in laminate touch castoro. Castoro embossed lacquered shelf with back in laminate tuttocolore touch castoro. Backs in fossena stone blaze. Snack top in spessart oak. Ventura stools in black elm and leather Soft 14 oliva. Left: close-up of pull-out storage basket in laminate touch bianco, plate holder and inner equipment in walnut canaletto and moka anodized aluminium.



A destra: basi e isola con ante, cassetti ed estrattori in laminato touch bianco. Top in laminato tuttocolore touch bianco con lavelli integrati. Piano cottura filotop a cinque fuochi personalizzato Poliform by Barazza e piani cottura Miele Smart Line a induzione con piastra Teppan Yaki in acciaio e vetroceramica. Cappa Flat a isola in acciaio scotch brite personalizzata Poliform.

Right: base units and island with doors, drawers and pull-out storage baskets in laminate touch bianco. Worktop in laminate tuttocolore touch bianco with integrated sinks. Personalized built-in hob with five burners Poliform by Barazza and induction hobs Miele Smart Line with Teppan Yaki griddle in steel and glass ceramics. Poliform personalized island-hood Flat in scotch brite steel.





A sinistra: dettaglio del top in laminato tuttocolore touch bianco, spessore 52 mm.

Left: close-up of the worktop in laminate tuttocolore touch bianco, thickness 2".

ALEA

Design R&D Poliform

Basi e isola p 737 - 1274

Strutture: nobilitato grigio lavagna.
 Ante, cassetti ed estrattori: laminato touch bianco.
 Maniglie: gola laccato goffrato bianco.
 Top basi: laminato tuttocolore touch bianco, spessore 52 mm.
 Top isola: laminato tuttocolore touch bianco, spessore 20 mm.
 Schienali: pietra fossena fiammata, laminato tuttocolore touch castoro.
 Zoccoli: laccato goffrato carbone.

Pannello con mensola p 405

Mensola: laccato goffrato castoro, spessore 30 mm.
 Schienali: laminato tuttocolore touch castoro, spessore 20 mm.

Colonne p 640

Strutture: nobilitato grigio lavagna.
 Ante: laminato touch castoro.
 Gola verticale: laccato goffrato castoro.

Pensili p 410

Strutture: nobilitato grigio lavagna.
 Ante: laminato touch castoro.
 Aperture: a ribalta con profilo luminoso.

Complementi

Sgabello Ventura: struttura in olmo nero e rivestimento in pelle Soft 14 oliva.

Base units and island d 29"- 50 1/4"

Structures: grey lavagna melamine.
 Doors, drawers and pull-out baskets: laminate touch bianco.
 Handles: bianco embossed lacquered channel.
 Base units top: laminate tuttocolore touch bianco, thickness 2".
 Island top: laminate tuttocolore touch bianco, thickness 3/4".
 Backs: fossena stone blaze, laminate tuttocolore touch castoro.
 Plinths: embossed lacquer carbone.

Panel with shelf d 16"

Shelf: embossed lacquer castoro, thickness 1 1/4".
 Backs: laminate tuttocolore touch castoro, thickness 3/4".

Tall units d 25 1/4"

Structures: grey lavagna melamine.
 Doors: laminate touch castoro. Vertical channel: embossed lacquer castoro.

Wall units d 16 1/4"

Structures: grey lavagna melamine.
 Doors: laminate touch castoro.
 Openings: flap doors with lighted profile.

Accessories

Ventura stool: structure in black elm and covering in leather Soft oliva 14.

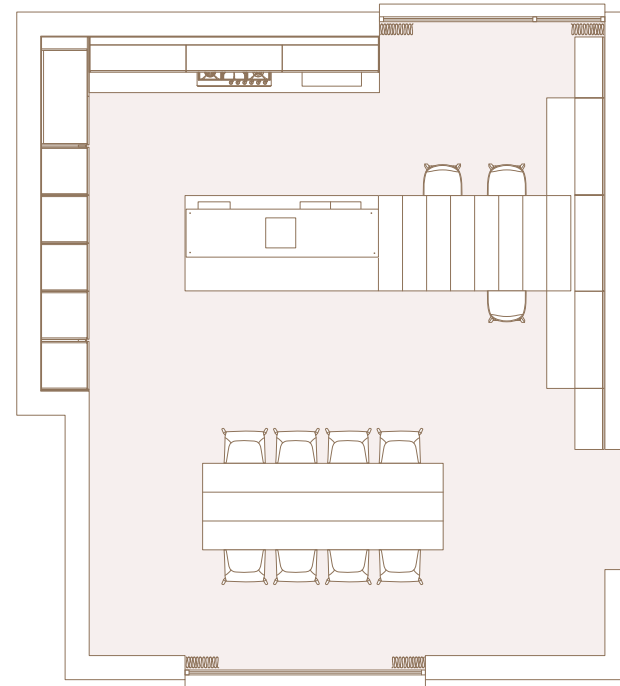
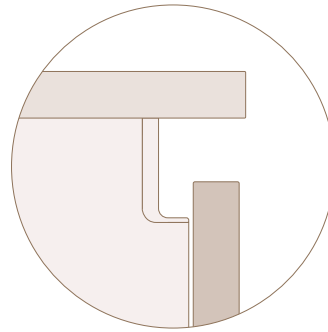

Isola Island

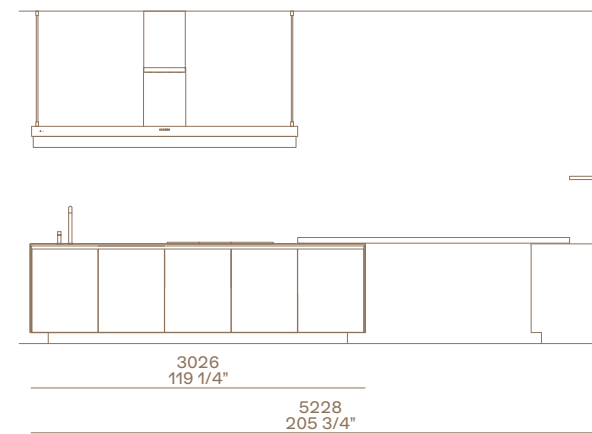

Colonne Tall units



Ventura

Design Jean-Marie Massaud



Basi e mensole Base units and shelves

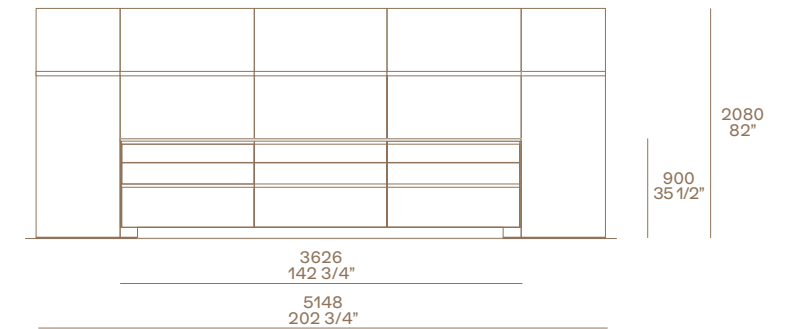

Basi e pensili Base units and wall units

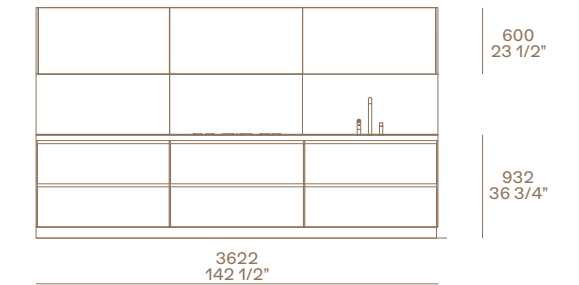

- 1 Colonne con forni, frigo/congelatore e macchina caffè da incasso standard con ante ad apertura battente ed estrattori.
- 2 Pensili con apertura a ribalta.
- 3 Cappa a scomparsa personalizzata Poliform.

- 4 Piano cottura acciaio scotch brite, 5 fuochi personalizzato Poliform by Barazza, incasso filotop.
- 5 Attrezzatura interna in noce canaletto e alluminio anodizzato moka.
- 6 Lavello integrato in laminato tuttocolore touch bianco con fondo acciaio scotch brite.

- 7 Piani cottura Miele Smart Line a induzione con piastra Teppan Yaki in acciaio e vetroceramica, incasso filotop.
- 8 Cappa Flat a isola in acciaio scotch brite personalizzata Poliform.
- 9 Mensole profondità 405 mm.

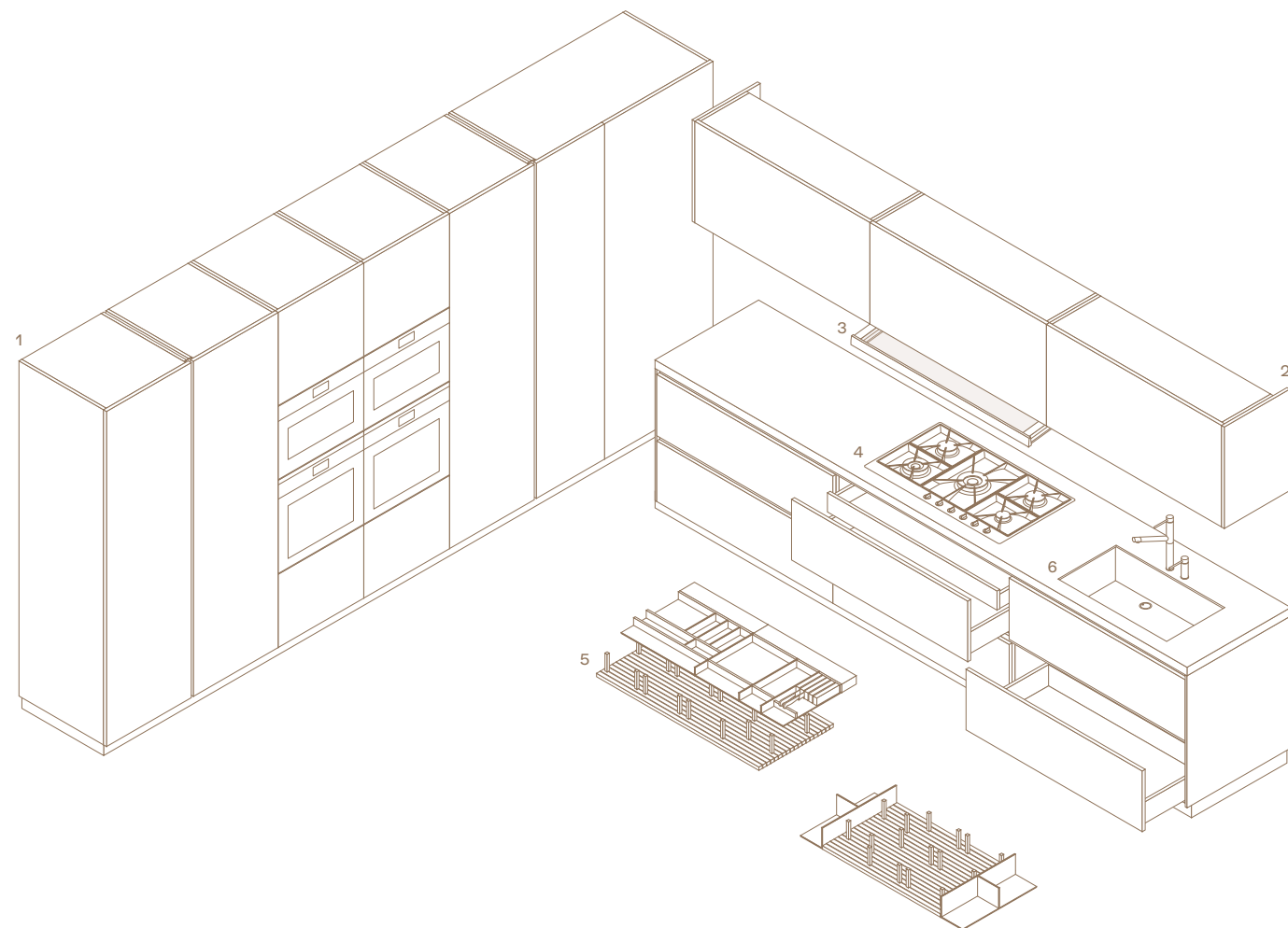

- 1 Tall units with ovens, fridge/freezer and standard built-in coffee machine with leaf doors and pull-out baskets.
- 2 Wall units with flap doors.
- 3 Poliform personalized built-in hood.

- 4 Hob in scotch brite steel with 5 burners personalized Poliform by Barazza, fully flush built-in.
- 5 Inner equipment in walnut canaletto and moka anodized aluminium.
- 6 Integrated sink in laminate tuttocolore touch bianco with bottom in scotch brite steel.

- 7 Induction hobs Miele Smart Line with Teppan Yaki griddle in steel and glass ceramics, fully flush built-in.
- 8 Poliform personalized island-hood Flat in scotch brite steel.
- 9 Shelves depth 16".

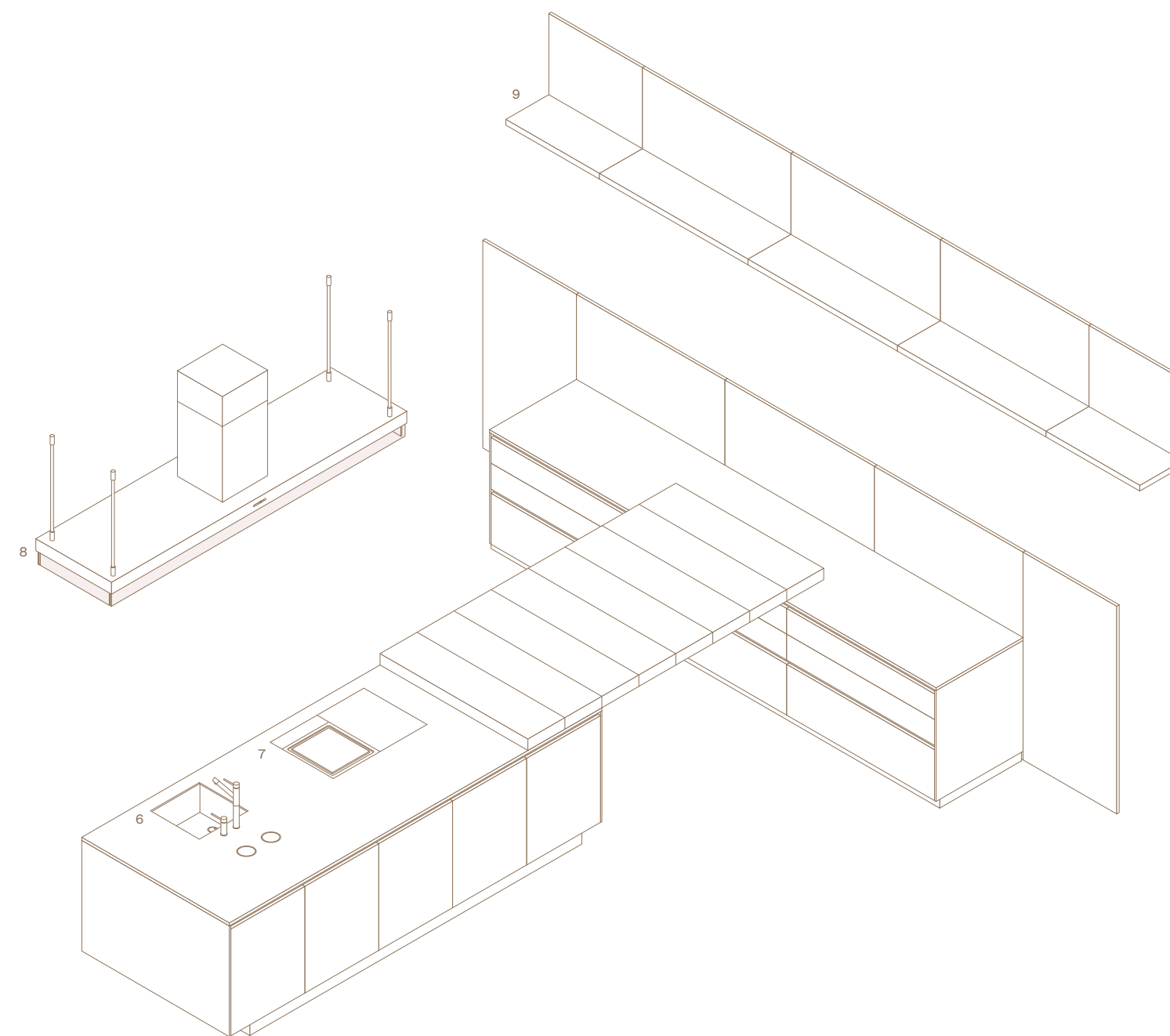



MY PLANET

Poliform reinterpreta la cucina con praticità e leggerezza. Merito di componenti come le maniglie, integrate o applicate, e di un'anta più leggera che consente la massima libertà nella scelta delle finiture. Particolari che determinano l'unicità di My Planet, un progetto in grado di dare vita a risultati compositivi originali ed esclusivi anche in ambienti dalle dimensioni contenute.

Poliform reinterprets the kitchen with practicality and lightness. This is thanks to components such as the handles, integrated or applied, and a lighter door that allows maximum freedom in the choice of finishes. Details that determine the uniqueness of My Planet, a project able to give life to original and exclusive compositional results even in environments of limited size.

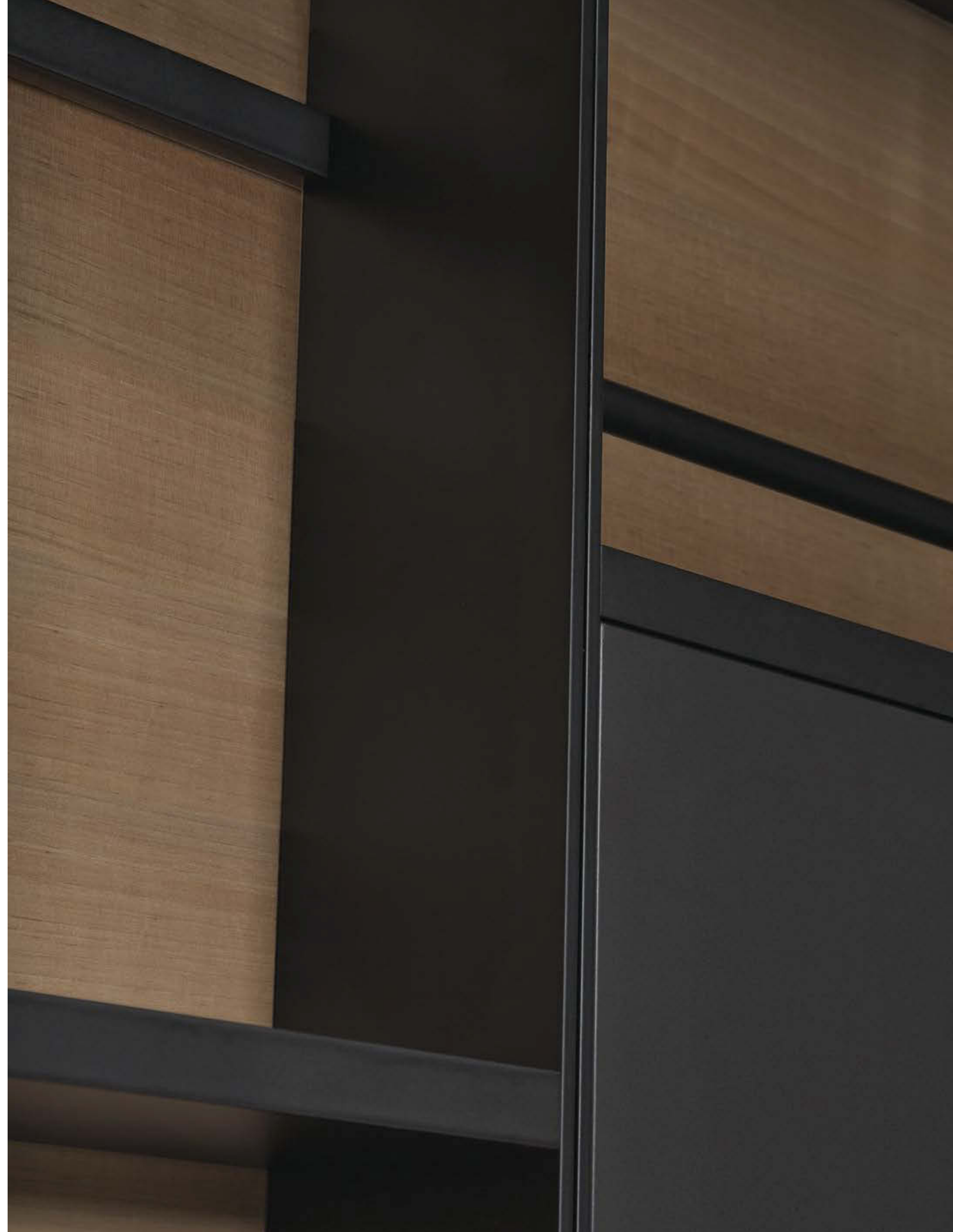



Qui e nella pagina precedente: basi con ante ed estrattori in acciaio scotch brite, top in pietra fossena fiammata e acciaio scotch brite. Pensili con ante in olmo nero e colonne con ante in acciaio scotch brite. Shaker con struttura e ripiani in anodizzato moka, schienali e tubi in olmo nero.

This and previous page: base units with doors and pull-out storage baskets in scotch brite steel, top in fossena stone blaze and scotch brite steel. Wall units with doors in black elm. Tall units with doors in scotch brite steel. Shaker with structure and shelves in anodized moka, back panels and hanging bars in black elm.

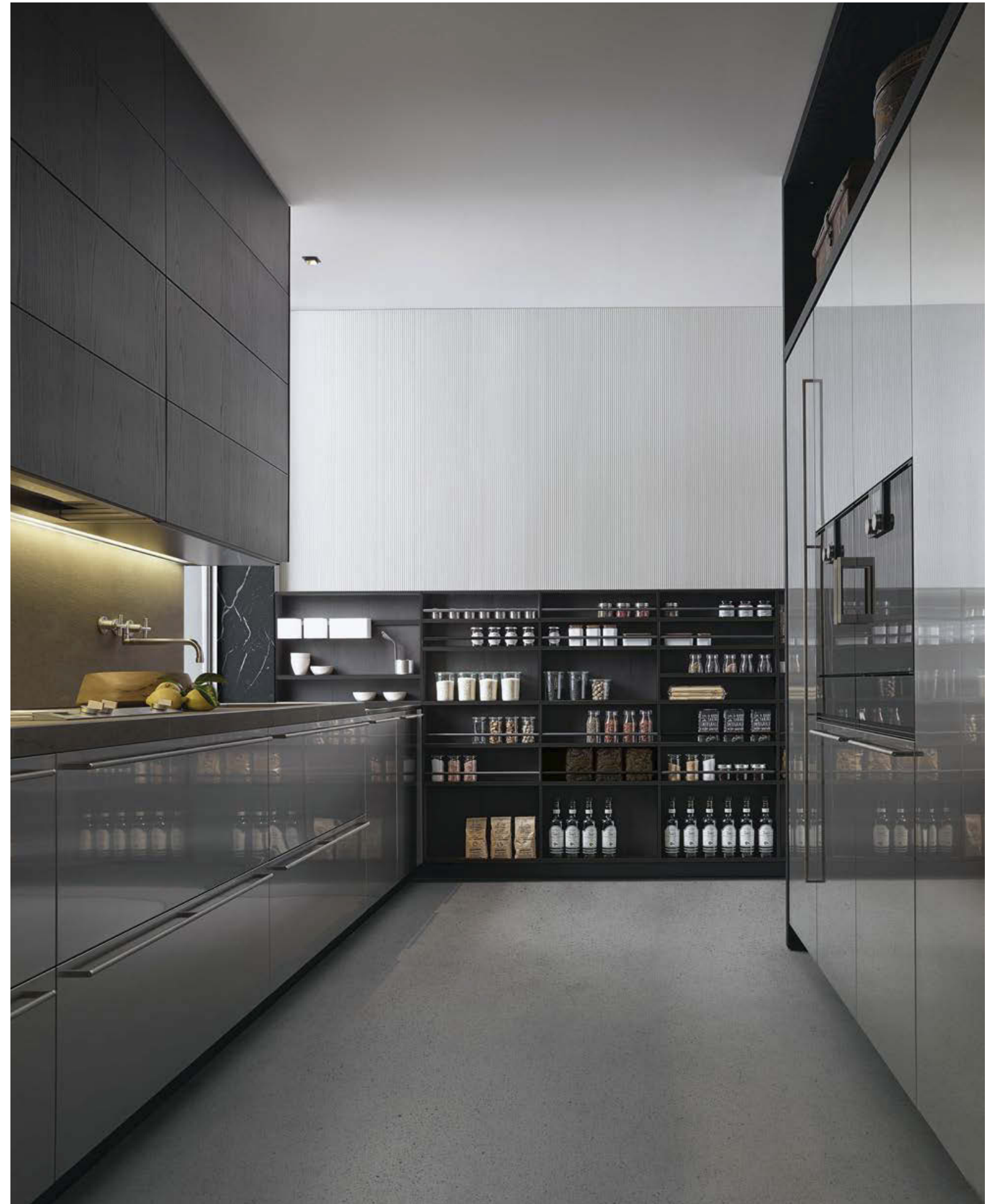



A sinistra: dettaglio di Shaker con struttura in anodizzato moka, schienali e tubi in olmo nero. Nella pagina successiva: top in pietra fossena fiammata e acciaio scotch brite con piano cottura Domino a quattro fuochi e grill elettrico, friggitrice e piastra Teppan Yaki, lavello in acciaio scotch brite. Cappe a scomparsa in acciaio scotch brite personalizzate Poliform. Schienali in pietra fossena fiammata. Ante ed estrattori in acciaio scotch brite con maniglie Grip in acciaio godronato.

Left: close-up of Shaker with structure in anodized moka, back panels and hanging bars in black elm. Next page: top in fossena stone blaze and scotch brite steel, with Domino hob with four burners and electric grill, deep fryer and Teppan Yaki griddle, scotch brite steel sink. Poliform personalized retractable hood in scotch brite steel. Back panels in fossena stone blaze. Doors and pull-out storage baskets in scotch brite steel with Grip handles in knurled steel.



A destra: dettaglio del pensile con ante in olmo nero con apertura pieghevole e profilo luminoso. Nella pagina successiva: dettaglio dell'estrattore con cassetto interno verniciato brown e attrezzatura in alluminio.

Right: close-up of wall units, folding doors in black elm with lighted profile. Next page: close-up of pull-out storage basket with painted brown inner drawer frame and equipment in aluminium.





MY PLANET

Design R&D Poliform

Basi p 737

Strutture: nobilitato grigio lavagna.
 Ante ed estrattori: acciaio scotch brite.
 Maniglie: Grip, acciaio godronato.
 Fianchi: acciaio scotch brite,
 spessore 6 mm.
 Top: pietra fossena fiammata
 spessore 52 mm; acciaio scotch brite
 Barazza, spessore 20 mm.
 Schienali: pietra fossena fiammata,
 spessore 20 mm.
 Zoccoli: laccato goffrato carbone.

Pensili p 410

Strutture: nobilitato grigio lavagna.
 Ante: olmo nero.
 Aperture: pieghevole con profilo
 luminoso, a ribalta con apertura tip-on.

Shaker p 120

Strutture: anodizzato moka.
 Schienali e tubi: olmo nero.

Colonne p 640

Strutture: nobilitato grigio lavagna.
 Ante: acciaio scotch brite.
 Maniglie: Grip, acciaio godronato.

Base units d 29"

Structures: grey lavagna melamine.
 Doors and pull-out storage baskets:
 scotch brite steel.
 Handles: Grip, knurled steel.
 Sides: scotch brite steel,
 thickness 1/4".
 Top: fossena stone blaze, thickness 2";
 Barazza scotch brite steel, thickness 3/4".
 Back panels: fossena stone blaze,
 thickness 3/4".
 Plinths: embossed lacquer carbone.

Wall units d 16 1/4"

Structures: grey lavagna melamine.
 Doors: black elm.
 Openings: folding with lighted profile,
 flap with tip-on opening.

Shaker d 4 3/4"

Structures: anodized moka.
 Back panels and bars: black elm.

Tall units d 25 1/4"

Structures: grey lavagna melamine.
 Doors: scotch brite steel.
 Handles: Grip, knurled steel.

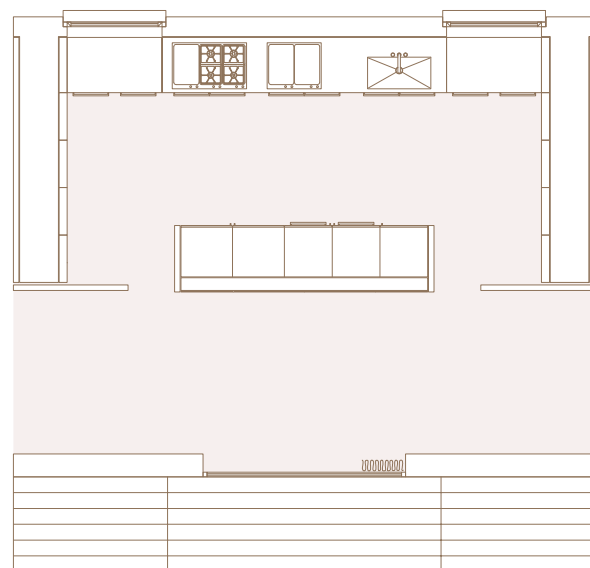
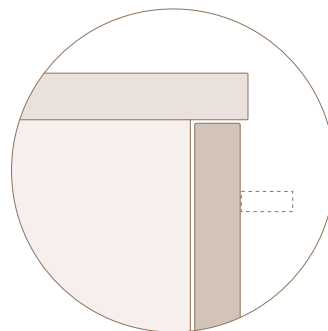

Basi e pensili Base units and wall units

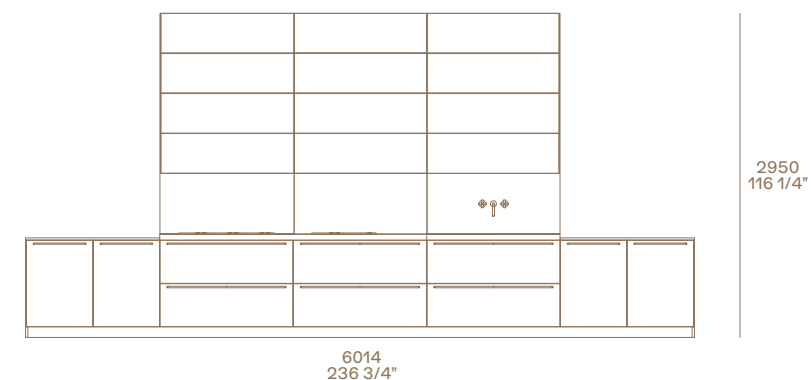

Shaker

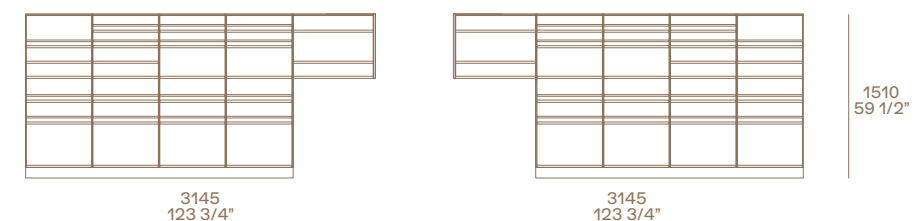

Colonne Tall units

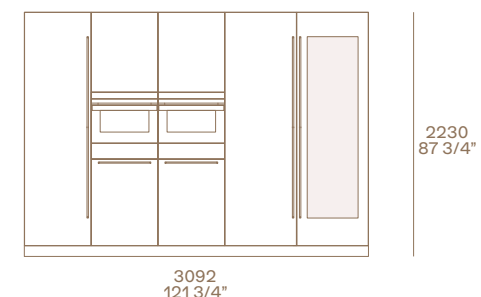

- 1 Piano cottura Domino con fuochi e grill elettrico, incasso tradizionale.
- 2 Friggitrice e piastra Teppan Yaki, incasso tradizionale.
- 3 Lavello in acciaio scotch brite, incasso sottotop.
- 4 Attrezzatura in alluminio per estrattori e cassetti interni.

- 5 Pensili apertura pieghevole con profilo luminoso, a ribalta con apertura tip-on. Cappe a scomparsa in acciaio scotch brite personalizzate Poliform.
- 6 Colonne con forno, scaldavivande, frigo/ congelatore con ante ed estrattori.

- 7 Cantina vini con ripiani estraibili in vetro e alluminio.
- 8 Shaker in anodizzato moka con tubi e schienali in olmo nero, contenitori in DuPont Corian® glacier white.

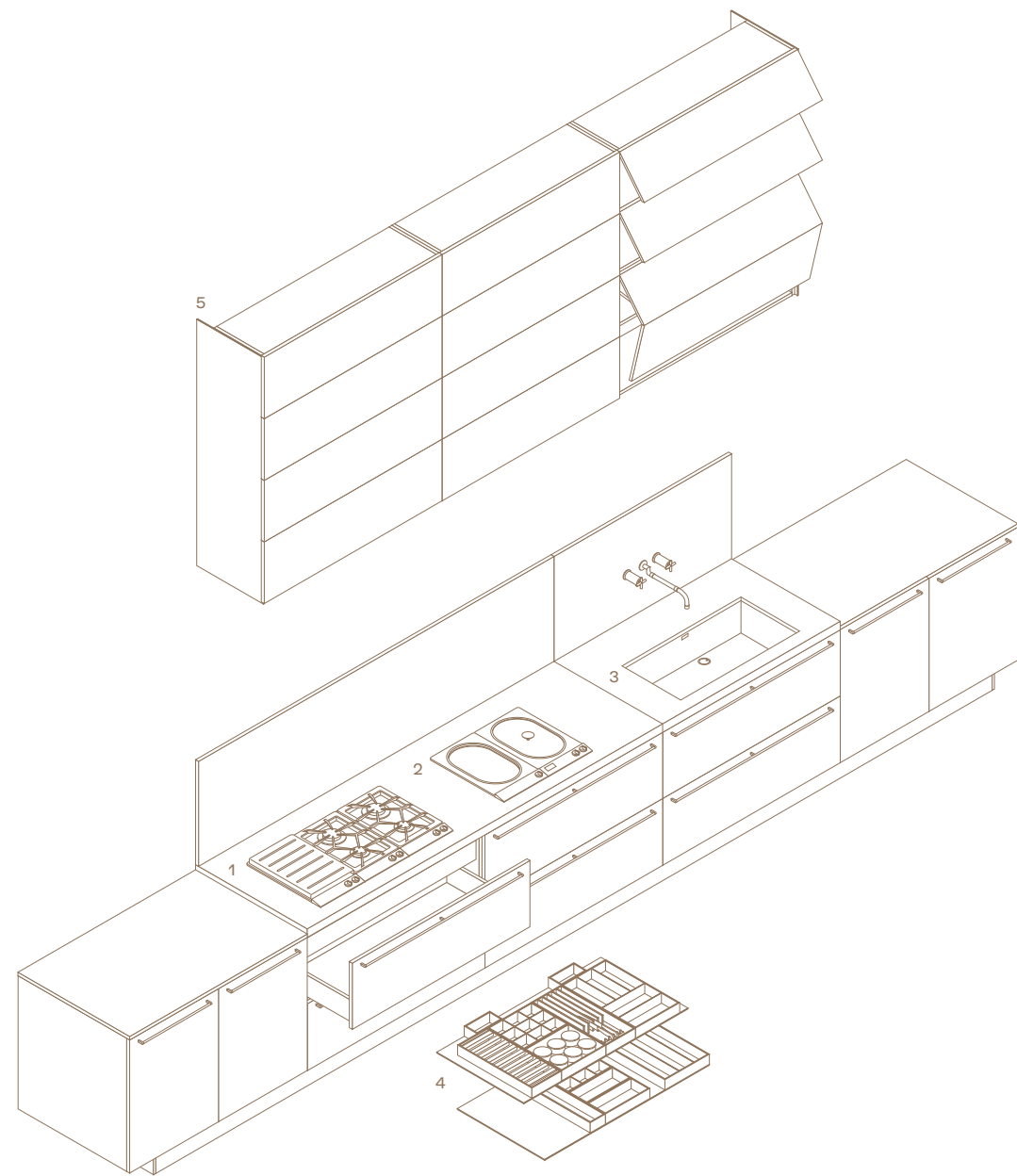

- 1 Domino hob with four burners and electric grill, classic built-in.
- 2 Deep fryer and Teppan Yaki griddle, classic built-in.
- 3 Scotch brite steel sink, underpump built-in.
- 4 Equipment in aluminium for pull-out storage baskets and inner drawers.

- 5 Wall units with folding doors with lighted profile, flap doors with tip-on opening. Poliform personalized pocket hoods in scotch brite steel.
- 6 Tall units with oven, plate warmer and fridge/freezer with doors and pull-out storage baskets.

- 7 Wine cooler with pull-out shelves in glass and aluminium.
- 8 Shaker in anodized moka with black elm bars and back panels, spice holders in DuPont Corian® glacier white.

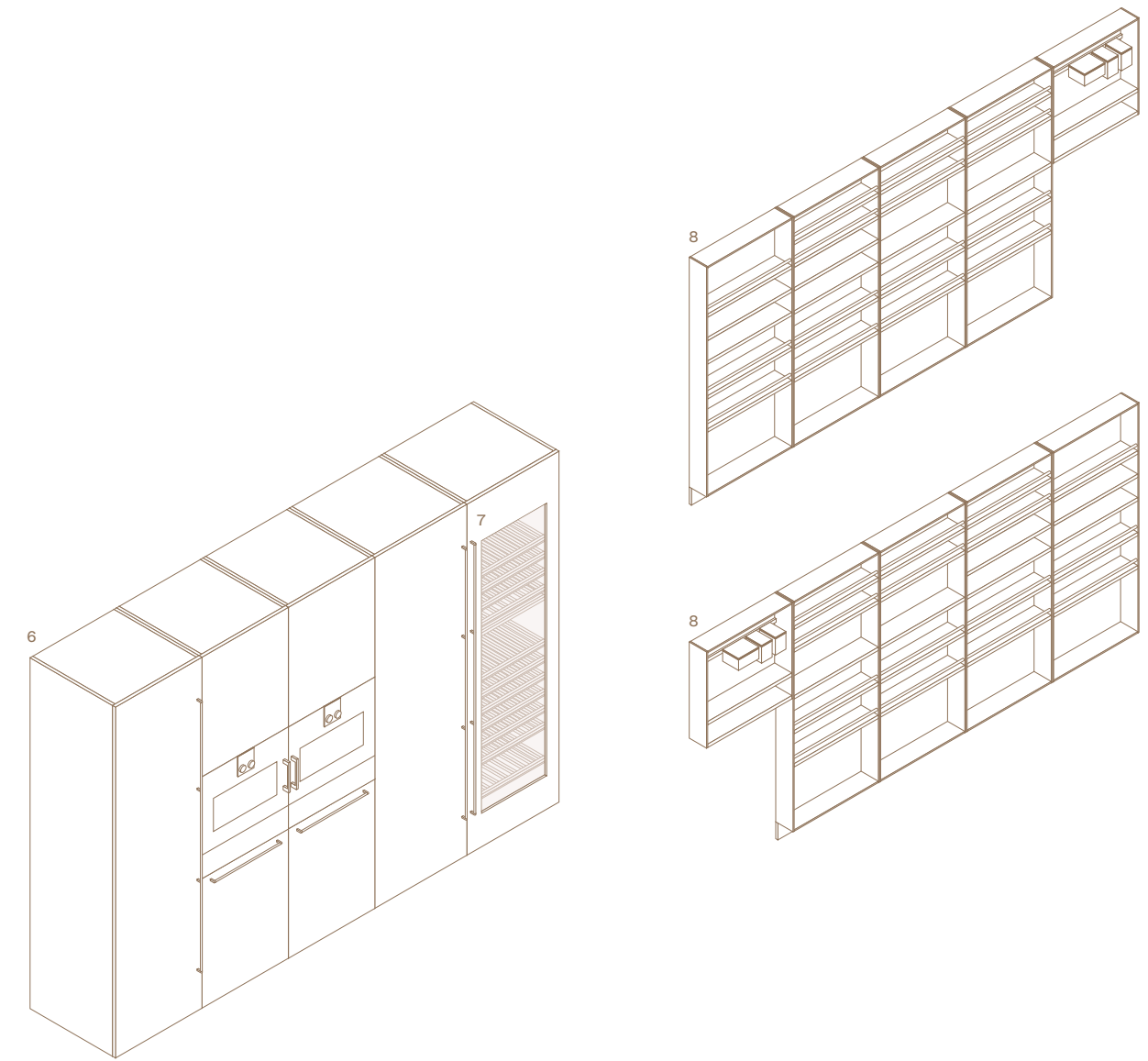

Qui e nella pagina successiva: basi con ante ed estrattori in LCT super white, maniglie integrate laccato goffrato moka, fianchi in Inalco MDi® roccia fiammata e laccato goffrato super white, top in Inalco MDi® roccia fiammata. Pensili con ante in LCT super white, maniglie integrate laccato goffrato moka e fianchi in laccato goffrato super white. Boiserie con pannelli in Inalco MDi® roccia fiammata e mensole in acciaio scotch brite. Colonne con ante, cassetti ed estrattori in STM bronzo e maniglie integrate laccato goffrato moka.

This and next page: base units with doors and pull-out storage baskets in LCT super white, integrated handles in embossed lacquer moka, sides in Inalco MDi® roccia fiammata and embossed lacquer super white, top in Inalco MDi® roccia fiammata. Wall units with doors in LCT super white, moka embossed lacquered integrated handles and sides in embossed lacquer super white. Wall panelling with panels in Inalco MDi® roccia fiammata and shelves in scotch brite steel. Tall units with doors, drawers and pull-out storage baskets in STM bronzo and moka embossed lacquered integrated handles.





A destra: basi con ante ed estrattori in LCT super white e maniglie integrate laccato gofrato moka. Fianchi, top e boiserie in Inalco MDi® roccia fiammata spessore 12 mm. Piano cottura a induzione, incasso filotop.

Right: base units with doors and pull-out storage baskets in LCT super white, integrated handles in embossed lacquer moka. Sides, top and wall panelling in Inalco MDi® roccia fiammata thickness 1/2". Induction hob, flush built-in.





A sinistra: dettaglio dell'estrattore con cassetto interno in alluminio anodizzato naturale, attrezzatura in noce canaletto e alluminio anodizzato moka. Top in Inalco MDi® roccia fiammata spessore 12 mm. Nella pagina successiva: basi con ante ed estrattori in LCT super white, maniglie integrate laccato goffrato moka, fianchi in Inalco MDi® roccia fiammata e laccato goffrato super white, top in Inalco MDi® roccia fiammata. Pensili con ante in LCT super white, maniglie integrate laccato goffrato moka e fianchi in laccato goffrato super white. Boiserie con pannelli in Inalco MDi® roccia fiammata e mensole in acciaio scotch brite. Colonne con ante, cassetti ed estrattori in STM bronzo e maniglie integrate laccato goffrato moka.

Left: close-up of the pull-out storage basket with inner drawer in natural anodized aluminium, equipment in walnut canaletto and moka anodized aluminium. Top in Inalco MDi® roccia fiammata thickness 1/2". Next page: base units with doors and pull-out storage baskets in LCT super white, integrated handles in embossed lacquer moka, sides in Inalco MDi® roccia fiammata and embossed lacquer super white, top in Inalco MDi® roccia fiammata. Wall units with doors in LCT super white, moka embossed lacquered integrated handles and sides in embossed lacquer super white. Wall panelling with panels in Inalco MDi® roccia fiammata and shelves in scotch brite steel. Tall units with doors, drawers and pull-out storage baskets in STM bronzo and moka embossed lacquered integrated handles.



Qui e nella pagina successiva: basi e pensili in LCT super white e maniglie integrate laccato gofrato moka. Fianchi, top e boiserie in Inalco MDi® roccia fiammata spessore 12 mm. Mensola in acciaio scotch brite spessore 3 mm. Barra retro pensile con luce a led integrata.

This and next page: base units and wall units in LCT super white and integrated handles in moka embossed lacquer. Sides, top and wall panelling in Inalco MDi® roccia fiammata thickness 1/2". Shelf in scotch brite steel thickness 1/8". Wall unit rear bar with integrated led light.





MY PLANET

Design R&D Poliform

Basi p 740

Strutture: nobilitato grigio perla.
 Ante ed estrattori: LCT super white.
 Maniglie: integrate My Planet, laccato goffrato moka.
 Fianchi: Inalco MDi® roccia fiammata, laccato goffrato super white, spessore 12 mm.
 Top: Inalco MDi® roccia fiammata, spessore 12 mm.
 Zoccoli: laccato goffrato moka.

Pensili p 410

Strutture: nobilitato grigio perla.
 Ante: LCT super white.
 Fianchi: laccato goffrato super white, spessore 12 mm.

Boiserie e mensole p 250

Pannelli: Inalco MDi® roccia fiammata.
 Mensole: acciaio scotch brite, spessore 3 mm.

Colonne p 640

Strutture: nobilitato grigio perla.
 Ante, cassetti ed estrattori: STM bronzo.
 Maniglie: integrate My Planet, laccato goffrato moka.

Base units d 29 1/4"

Structures: grey perla melamine.
 Doors and pull-out storage baskets: LCT super white.
 Handles: integrated My Planet, embossed lacquer moka.
 Sides: Inalco MDi® roccia fiammata, embossed lacquer super white, thickness 1/2".
 Top: Inalco MDi® roccia fiammata, thickness 1/2".
 Plinths: embossed lacquer moka.

Wall units d 16 1/4"

Structures: grey perla melamine.
 Doors: LCT super white.
 Sides: embossed lacquer super white, thickness 1/2".

Wall panelling and shelves d 9 3/4"

Panels: Inalco MDi® roccia fiammata.
 Shelves: scotch brite steel, thickness 1/8".

Tall units d 25 1/4"

Structures: grey perla melamine.
 Doors, drawers and pull-out storage baskets: STM bronzo.
 Handles: integrated My Planet, embossed lacquer moka.

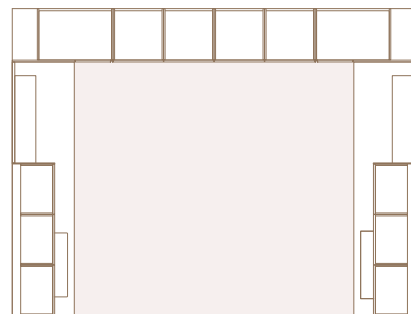
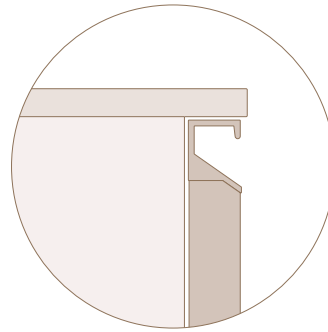

Basi, pensili, boiserie Base units, wall units, wall panelling

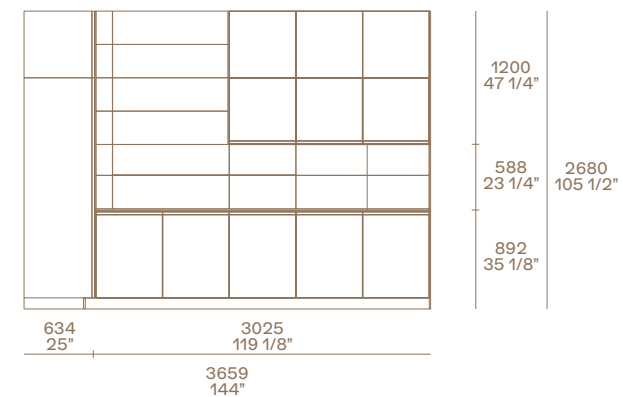
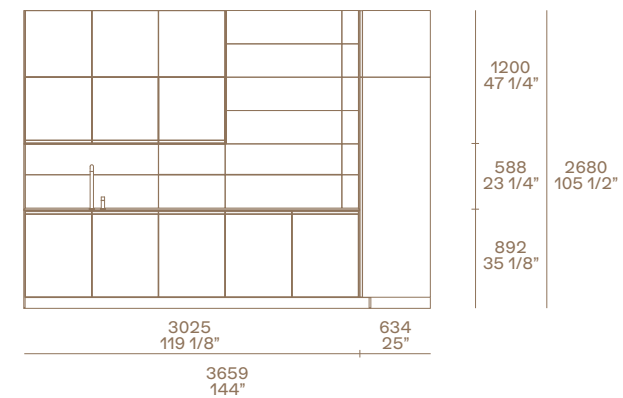

Colonne Tall units

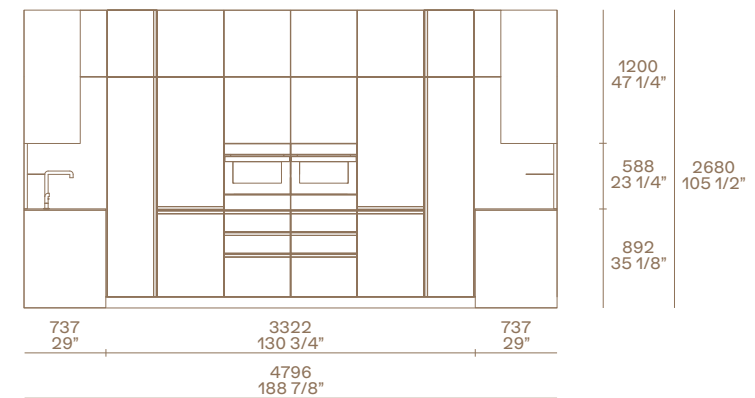

- 1 Basi con ante ed estrattori con maniglie integrate My Planet.
- 2 Pensili con ante a ribalta, inferiori con maniglia integrata, superiori con apertura tip-on.
- 3 Boiserie con pannelli spessore 12 mm.
- 4 Mensole spessore 3 mm.
- 5 Lavello in acciaio scotch brite, incasso sottotop.

- 6 Attrezzature in noce canaletto e alluminio anodizzato moka per cassetti interni ed estrattori.
- 7 Colonne con forno multifunzione compatto, forno multifunzione combinato microonde, scaldastoviglie, cassetto sottovuoto, frigo/congelatore, ante, estrattori e cassetti.

- 8 Piano cottura a induzione, incasso filotop.
- 9 Cappa Easy 1200 mm in acciaio scotch brite personalizzata Poliform.

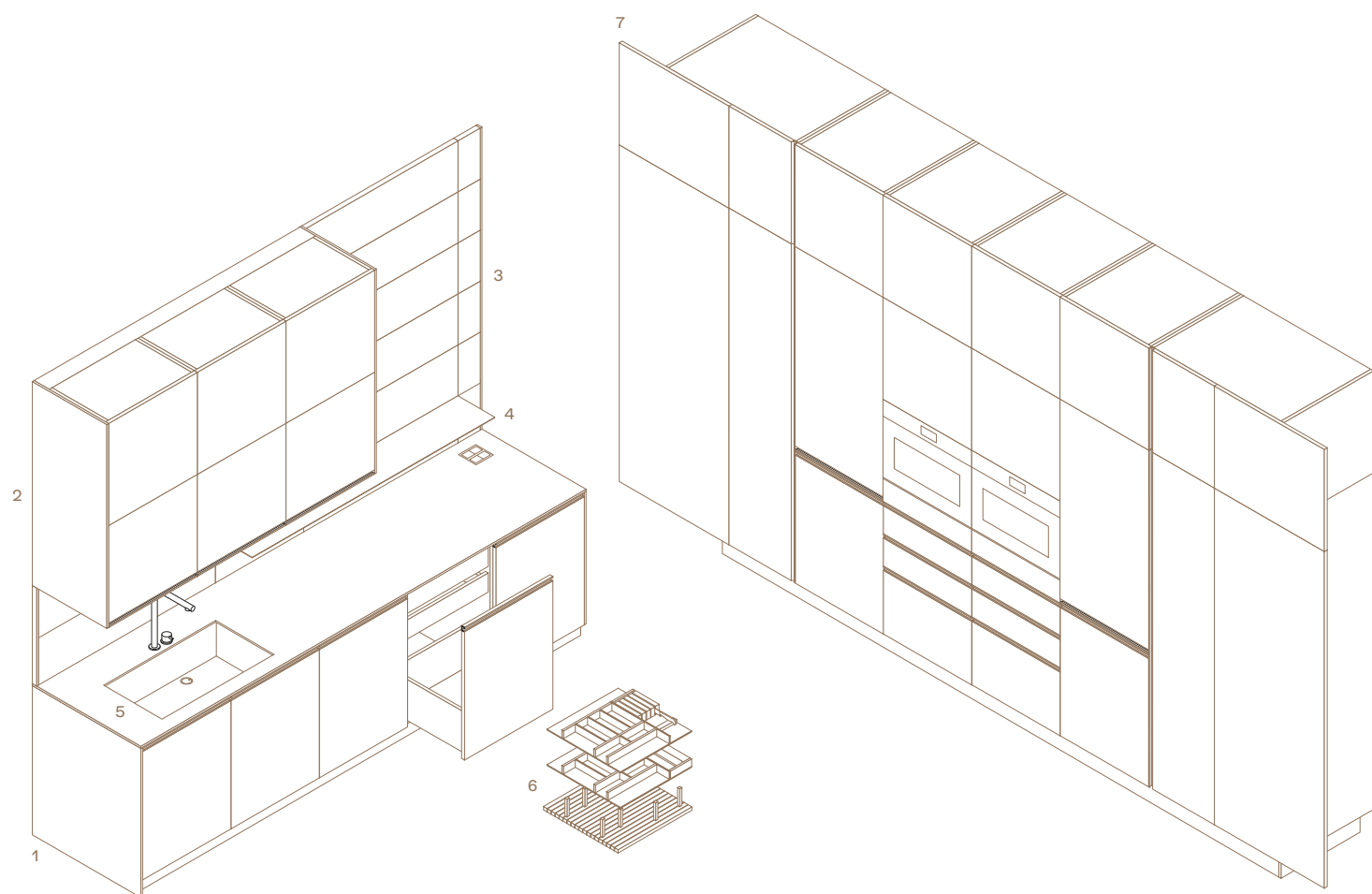

- 1 Base units with doors and pull-out storage baskets with My Planet integrated handles.
- 2 Wall units with flap doors, lower doors with integrated handle, upper doors with tip-on opening.
- 3 Wall panelling with panels thickness 1/2".
- 4 Shelves thickness 1/8".
- 5 Sink in scotch brite steel, undermount built-in.

- 6 Equipment in walnut canaletto and moka anodized aluminium for inner drawers and pull-out storage baskets.
- 7 Tall units with compact multifunction oven, combined microwave multifunction oven, dish warmer, vacuum drawer, fridge/freezer with doors, pull-out storage baskets and drawers.

- 8 Induction hob, flush built-in.
- 9 Easy hood 47 1/4" in scotch brite steel personalized Poliform.

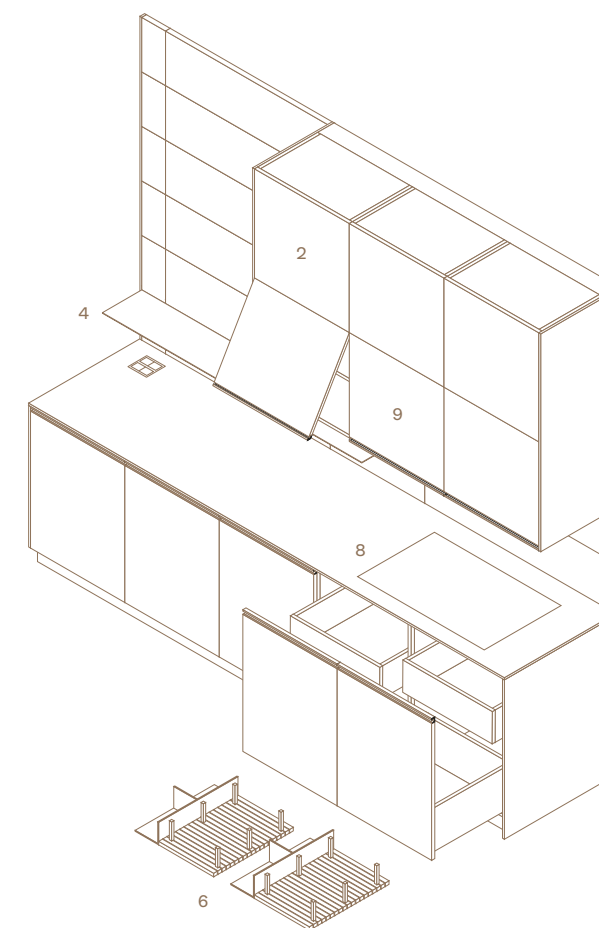

TWELVE

Twelve è l'esito di una ricerca estrema di essenzialità. Progettando l'anta più sottile della gamma, Carlo Colombo e Poliform disegnano una cucina dall'estetica rigorosa, equilibrata tra minimi spessori e massima ampiezza delle superfici. La grande varietà di finiture e materiali disponibili – dal vetro all'acciaio – apre a ogni possibile interpretazione stilistica.

Twelve is the result of an extreme search for minimalism. By creating the thinnest door of the range, Carlo Colombo and Poliform design a kitchen with a rigorous look, balanced between minimum thickness and maximum width of the surfaces. The wide variety of finishes and materials available – from glass to steel – opens up any possible stylistic interpretation.





Nella pagina precedente: basi con ante, cassetti ed estrattori in vetro satinato extrachiaro bianco con gola in laccato goffrato carbone, top e fianchi in dektion bianco. Cappa Work a isola in acciaio scotch brite e vetro. Colonne con ante in laccato metallico bronzo. In appoggio sulle basi, piano snack Sydney in massello tinto olmo nero. A destra: piano cottura filotop a cinque fuochi e lavello sottotop in acciaio scotch brite personalizzati Poliform by Barazza.

Previous page: base units with doors, drawers and pull-out storage baskets in extralight bianco frosted glass with embossed lacquered carbone channel, top and sides in dektion bianco. Work island-hood in scotch brite steel and glass. Tall units with doors in metal lacquer bronzo. Placed on the base units, Sydney snack top in solid wood stained black elm. Right: five-burners fully flush built-in hob and undermount built-in sink in scotch brite stainless steel, personalized Poliform by Barazza.





A sinistra: basi con cassetti ed estrattori in vetro satinato extrachiaro bianco con telaio di supporto in alluminio anodizzato nero e gola in laccato goffrato carbone, top e fianchi in dektion bianco. In appoggio sulle basi, piano snack Sydney in massello tinto olmo nero.

Left: base units with doors, drawers and pull-out storage baskets in extralight bianco frosted glass with support frame in black anodized aluminium and carbone embossed lacquered channel, top and sides in dektion bianco. Placed on the base units, Sydney snack top in solid wood stained black elm.

A destra: dettaglio dell'anta in vetro satinato extrachiaro bianco con telaio di supporto in alluminio anodizzato nero e gola in laccato goffrato carbone. Top e fianco in dekton bianco.

Right: close-up of the door in extralight bianco frosted glass with support frame in black anodized aluminium and carbone embossed lacquered channel, top and sides in dekton bianco.







Qui e nella pagina precedente: basi con ante, cassetti ed estrattori in vetro satinato extrachiaro bianco con telaio di supporto in alluminio anodizzato nero e gola in laccato goffrato carbone, top e fianchi in dekton bianco. Cappa Work a isola in acciaio scotch brite e vetro. Colonne con ante in laccato metallico bronzo e colonne con ante vetrina PR22 in vetro riflettente fumé, profilo anodizzato nero e maniglia integrata verniciata nero. In appoggio sulle basi, piano snack Sydney in massello tinto olmo nero.

This and previous page: base units with doors, drawers and pull-out storage baskets in extralight bianco frosted glass with support frame in black anodized aluminium and carbone embossed lacquered channel, top and sides in dekton bianco. Work island-hood in scotch brite steel and glass. Tall units with doors in metal lacquer bronzo and tall units PR22 with fumé reflective glass doors, black anodized profile and integrated black painted handle. Placed on the base units, Sydney snack top in solid wood stained black elm.



A destra: dettaglio dell'anta vetrina PR22 con maniglia integrata, cassettiere in laminato touch nero, ripiani in vetro fumé con telaio in alluminio anodizzato nero e illuminazione a led integrata. Nella pagina precedente: colonne con ante vetrina PR22 in vetro riflettente fumé, profilo anodizzato nero e maniglia integrata verniciato nero. Pouf New York con rivestimento non sfoderabile in pelle Soft 1 crema e piedini brown nickel lucido.

Right: a detail of the glass door PR22 with integrated handle, chests of drawers in laminate touch nero, fumé glass shelves with black anodized aluminium frame and integrated led lighting. Previous page: tall units PR22 with fumé reflective glass doors, black anodized profile and integrated black painted handle. Pouf New York with cover in non-removable leather Soft 1 crema and glossy brown nickel feet.





A sinistra: colonne con ante vetrina PR22 in vetro riflettente fumé, profilo anodizzato nero e maniglia integrata verniciato nero. All'interno, ripiani in vetro fumé con telaio in alluminio anodizzato nero e illuminazione a led integrata.

Left: tall units PR22 with fumé reflective glass doors, black anodized profile and integrated black painted handle. Inside, fumé glass shelves with black anodized aluminium frame and integrated led lighting.

TWELVE

Design Carlo Colombo and R&D Poliform

Basi p 1256

Strutture: nobilitato grigio lavagna.
 Ante, cassetti ed estrattori: vetro satinato 2301 extrachiaro bianco, telaio anodizzato nero.
 Fianchi: dektion bianco, spessore 12 mm.
 Top: dektion bianco con telaio di supporto laccato goffrato carbone.
 Zoccoli: laccato goffrato carbone.

Snack Sydney

Massello tinto olmo nero.

Colonne p 640

Strutture: nobilitato grigio lavagna.
 Ante: laccato metallico bronzo.
 Fianchi: laccato metallico bronzo, spessore 12 mm.
 Gole verticali: laccato metallico bronzo.

Colonne vetrina PR22 p 640

Strutture: nobilitato grigio lavagna.
 Ante: vetro 5059 riflettente fumé, profilo anodizzato nero.
 Maniglia: integrata verniciato nero.
 Fianchi: laccato goffrato carbone, spessore 12 mm.

Base units d 49 1/2"

Structures: grey lavagna melamine.
 Doors, drawers and pull-out storage baskets: frosted glass 2301 extralight bianco, black anodized frame.
 Sides: dektion bianco, thickness 1/2".
 Top: dektion bianco with support frame in embossed lacquer carbone.
 Plinths: embossed lacquer carbone.

Sydney snack

Solid wood dyed black elm.

Tall units d 25 1/4"

Structures: grey lavagna melamine.
 Doors: metal lacquer bronzo.
 Sides: metal lacquer bronzo, thickness 1/2".
 Vertical channels: metal lacquer bronzo.

Glass tall units PR22 d 25 1/4"

Structures: grey lavagna melamine.
 Doors: glass 5059 fumé reflective, profile black anodized.
 Handle: integrated painted black.
 Sides: embossed lacquer carbone thickness 1/2".

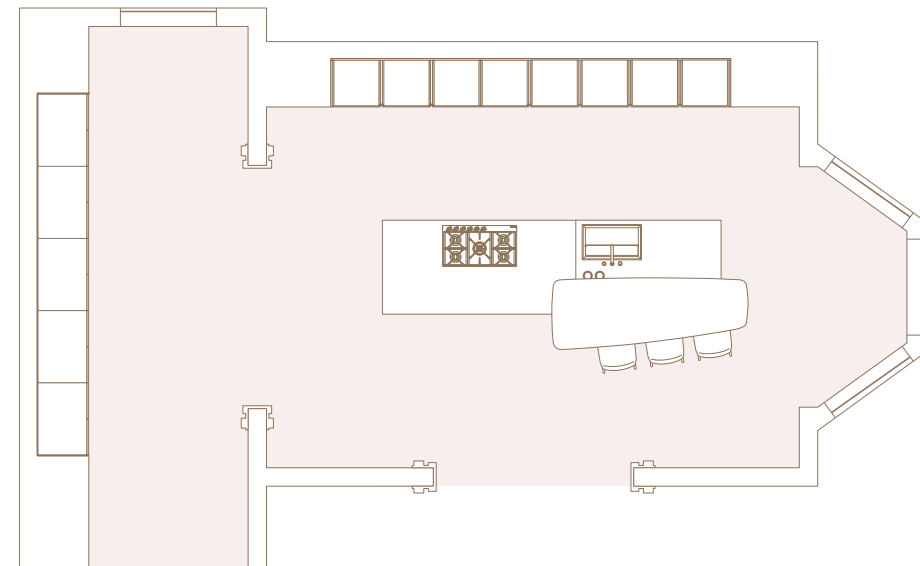
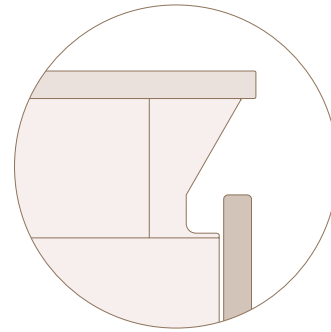

Basi Base units

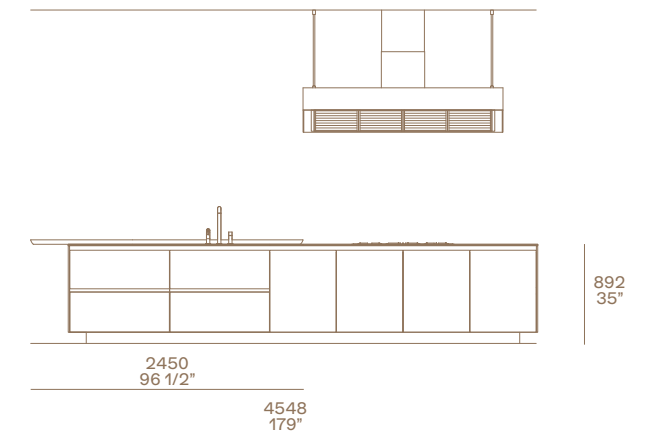
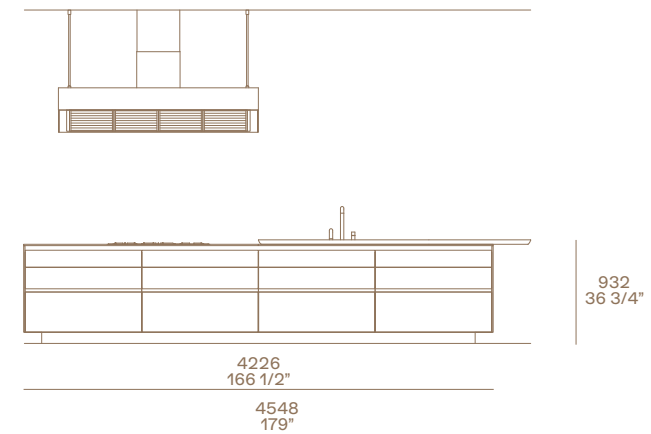

Colonne Tall units

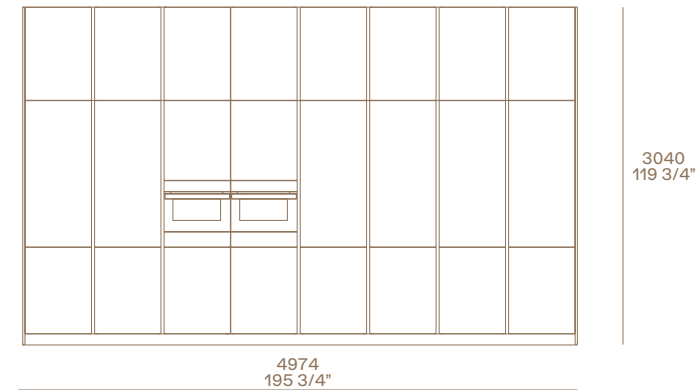

Colonne vetrina Glass tall units

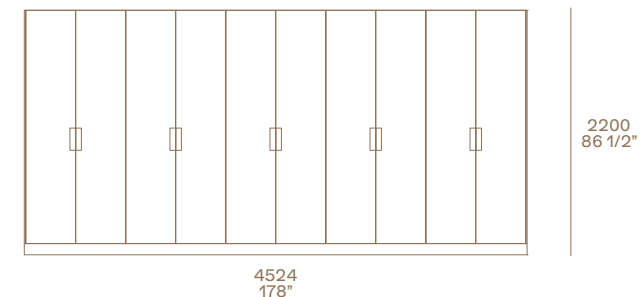

- 1 Colonne con forni e frigoriferi con ante ad apertura battente ed estrattori, cassetti interni in noce canaletto e attrezzatura in noce canaletto e alluminio anodizzato moka.
- 2 Piano cottura filotop 5 fuochi in acciaio scotch brite personalizzato Poliform by Barazza.

- 3 Lavello sottotop in acciaio scotch brite personalizzato Poliform by Barazza.
- 4 Piano snack Sydney 2450 x 895 mm.
- 5 Attrezzatura in noce canaletto e alluminio anodizzato moka per cassetti ed estrattori.

- 6 Cappa Work a isola in acciaio scotch brite e vetro, personalizzata Poliform.
- 7 Colonne vetrina PR22 con ante ad apertura battente, cassettiere in laminato touch nero e ripiani in vetro fumé con telaio in alluminio anodizzato nero.

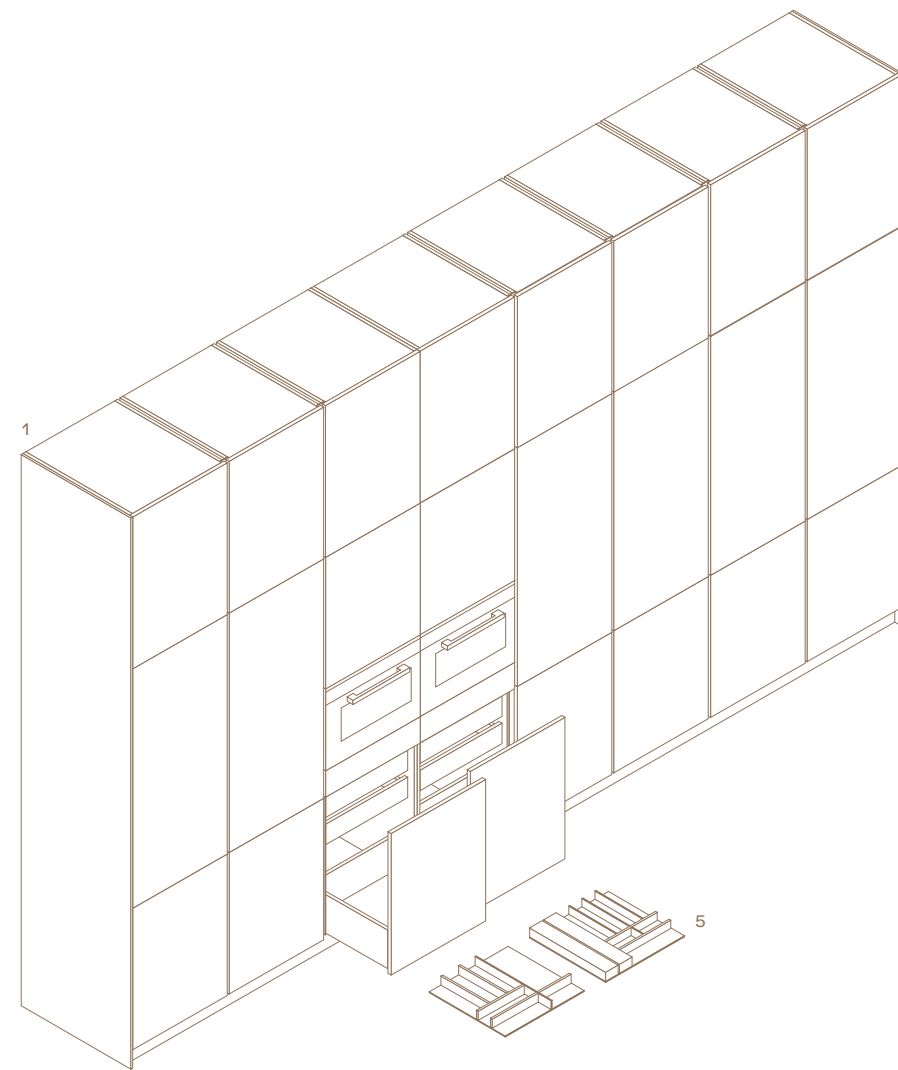

- 1 Tall units with ovens and refrigerators, pull-out storage baskets for tall unit with internal drawers in walnut canaletto and equipment in walnut canaletto and moka anodized aluminium, leaf doors.
- 2 Fully flush built-in hob 5 burners in scotch brite steel personalized Poliform by Barazza.

- 3 Undermount built-in sink in scotch brite steel personalized Poliform by Barazza.
- 4 Snack top Sydney 96 1/2" x 31 1/4".
- 5 Equipment in walnut canaletto and moka anodized aluminium for drawers and pull-out storage baskets.

- 6 Island-hood Work in scotch brite steel and glass, personalized Poliform.
- 7 Glass tall units PR22, leaf doors, equipped with chests of drawers in laminate touch nero and fumé glass shelves with black anodized aluminium frame.

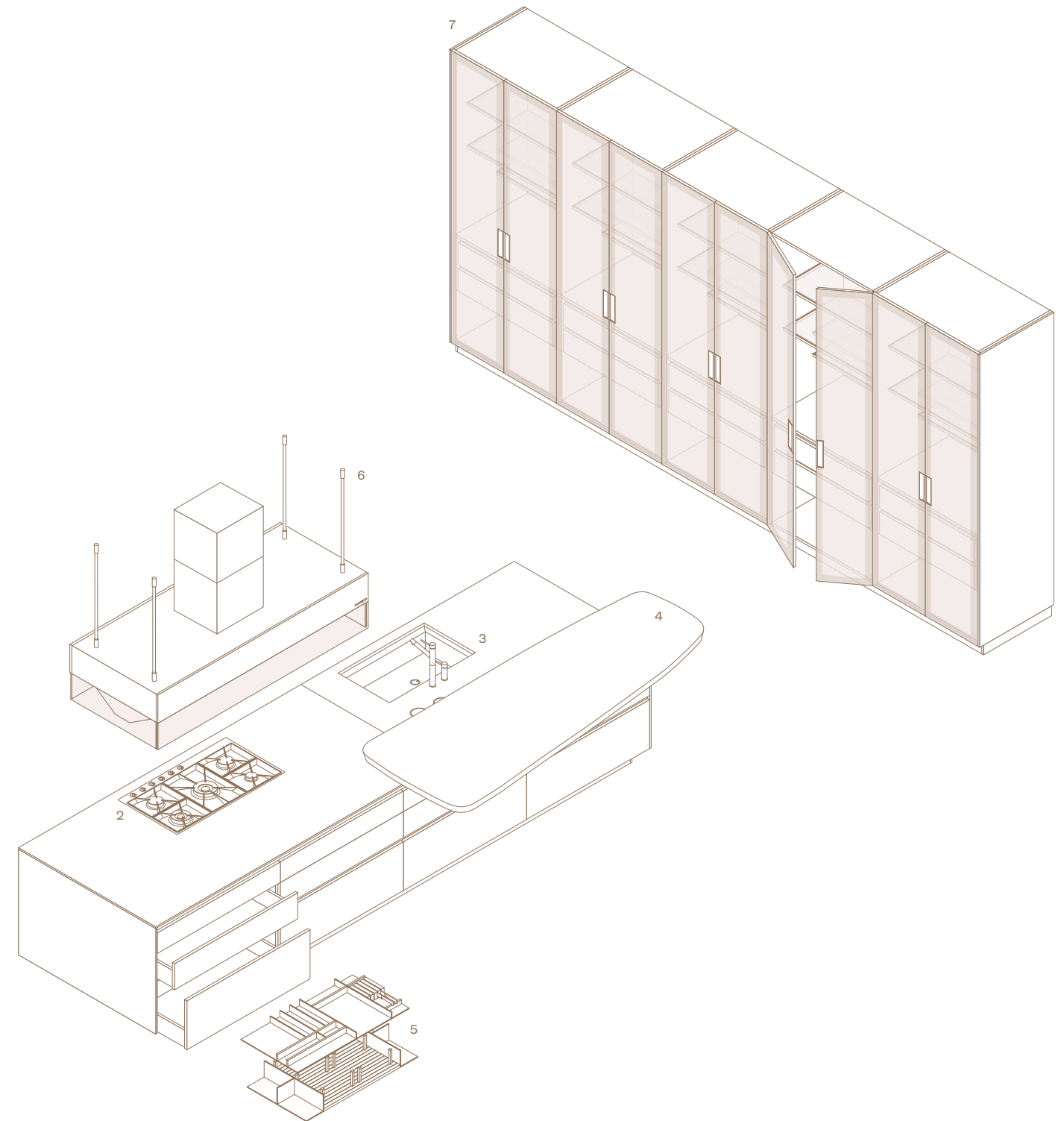

A destra: basi con ante, cassetti ed estrattori in acciaio scotch brite, top in acciaio scotch brite con telaio di supporto in alluminio laccato goffrato carbone. Shaker con struttura in alluminio anodizzato moka, schienali in noce c. e tubi in laccato goffrato moka.

Right: base units with doors, drawers and pull-out storage baskets in scotch brite steel, top in scotch brite steel with carbone embossed lacquered aluminium support frame. Shaker with structure in anodized moka, back panels in walnut c. and bars in embossed lacquer moka.







Qui e nella pagina precedente: basi con ante, cassetti ed estrattori in acciaio scotch brite, top in acciaio scotch brite con telaio di supporto in alluminio laccato goffrato carbone. Colonne con ante in vetro satinato nero e telaio anodizzato nero. Piano snack Blade in massello noce canaletto.

This and previous page: base units with doors, drawers and pull-out storage baskets in scotch brite steel, top in scotch brite steel with carbone embossed lacquered aluminium support frame. Tall units with doors in black frosted glass and black anodized frame. Blade snack table in solid wood walnut canaletto.



A destra: basi con ante, cassetti ed estrattori in acciaio scotch brite, top in acciaio scotch brite con telaio di supporto in alluminio laccato goffrato carbone. Colonne con ante in vetro satinato nero e telaio anodizzato nero. Shaker con struttura in alluminio anodizzato moka, schienali in noce c. e tubi in laccato goffrato moka. Nella pagina precedente: dettaglio del piano snack Blade in massello noce canaletto.

Right: base units with doors, drawers and pull-out storage baskets in scotch brite steel, top in scotch brite steel with carbone embossed lacquered aluminium support frame. Tall units with doors in black frosted glass and black anodized frame. Shaker with structure in anodized moka, back panels in walnut c. and bars in embossed lacquer moka. Previous page: close-up of the Blade snack table in solid wood walnut canaletto.







A sinistra: dettaglio dell'anta in acciaio scotch brite e gola in laccato gofrato carbone. Top e fianco in acciaio scotch brite. Nella pagina precedente: dettaglio del cassetto interno verniciato brown con sistema di illuminazione interna a led. Attrezzatura in noce canaletto e alluminio anodizzato moka con portaposate, portacoltelli e portaspesie in ceramica.

Left: close-up of the door in scotch brite steel and channel in embossed lacquer carbone. Top and side in scotch brite steel. Previous page: close-up of inner drawer painted brown with inner led lighting system. Equipment in walnut canaletto and moka anodized aluminium with pot rack, knife rack and spice rack in ceramic.

Nella pagina successiva: basi con ante, cassetti ed estrattori in acciaio scotch brite, top in acciaio scotch brite con telaio di supporto in alluminio laccato gofrato carbone. Colonne con ante in vetro satinato nero e telaio anodizzato nero. Shaker con struttura in alluminio anodizzato moka, schienali in noce c. e tubi in laccato gofrato moka. Piano snack Blade in massello noce canaletto. A destra: estrattore per colonna con anta in vetro satinato nero e telaio di alluminio anodizzato nero con sistema di illuminazione interna a led. Piattaia, cassetti interni e attrezzatura in noce canaletto e alluminio anodizzato moka.

Next page: base units with doors, drawers and pull-out storage baskets in scotch brite steel, top in scotch brite steel with carbone embossed lacquered aluminium support frame. Tall units with doors in black frosted glass and black anodized frame. Shaker with structure in anodized moka, back panels in walnut c. and bars in embossed lacquer moka. Blade snack table in solid wood walnut canaletto. Right: pull-out storage basket for tall unit with black frosted glass door and black anodized aluminium frame with led lighting system. Plate rack, inner drawers and equipment in walnut canaletto and moka anodized aluminium.

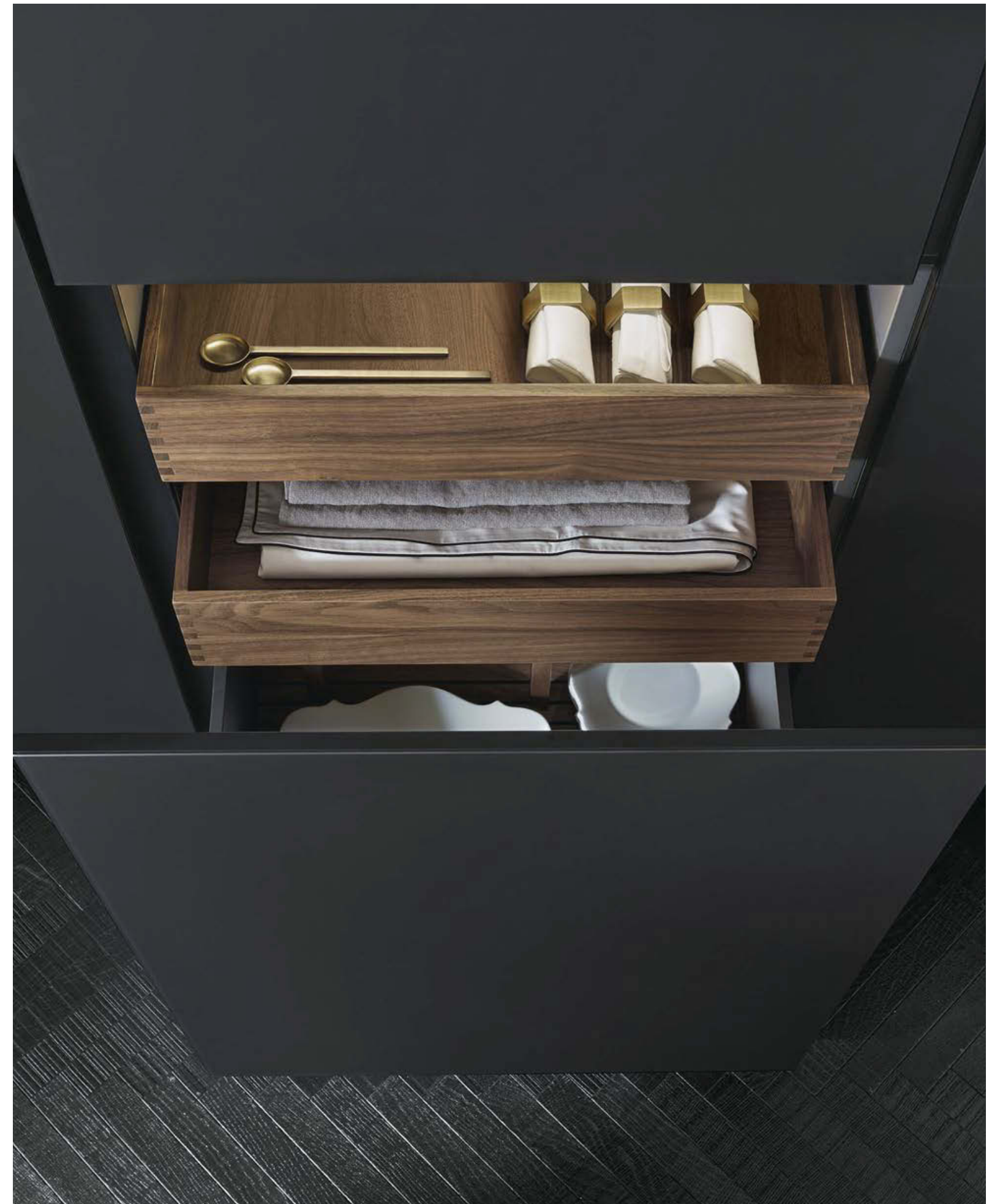





A sinistra: top in acciaio scotch brite con telaio di supporto in alluminio laccato goffrato carbone. Piano cottura a cinque fuochi in acciaio scotch brite saldato personalizzato Poliform by Barazza. Cappa Downdraft a scomparsa in acciaio scotch brite e vetro nero. Cassetti ed estrattori in acciaio scotch brite.

Left: top in scotch brite steel with carbone embossed lacquered aluminium support frame. Personalized soldered scotch brite steel hob with five burners Poliform by Barazza. Downdraft retractable hood in scotch brite steel and black glass. Drawers and pull-out storage baskets in scotch brite steel.

A destra: dettaglio del piano cottura a cinque fuochi in acciaio scotch brite saldato personalizzato Poliform by Barazza. Cappa Downdraft a scomparsa in acciaio scotch brite e vetro nero, finotop. Cassetti ed estrattori in acciaio scotch brite, interno in verniciato brown con pia-taia in noce canaletto.

Right: close-up of the personalized soldered scotch brite steel hob with five burners Poliform by Barazza. Downdraft retractable hood in scotch brite steel and black glass, flush built-in. Drawers and pull-out storage baskets in scotch brite steel, interior painted brown with walnut canaletto plate holder.



TWELVE

Design Carlo Colombo and R&D Poliform

Basi p 1252

Strutture: nobilitato grigio lavagna.
 Ante, cassetti ed estrattori: acciaio scotch brite Ronda.
 Fianchi: acciaio scotch brite, spessore 12 mm.
 Top: acciaio scotch brite Barazza con telaio di supporto laccato goffrato carbone.
 Zoccoli: laccato goffrato carbone.

Snack Blade

Massello noce canaletto.

Colonne p 640

Strutture: nobilitato grigio lavagna.
 Ante: vetro satinato nero 1303 con telaio in alluminio anodizzato nero.
 Fianchi: vetro satinato extrachiaro nero 2303, spessore 12 mm.
 Gole verticali: laccato carbone.

Shaker p 120

Strutture: alluminio anodizzato moka.
 Schienali: noce c.
 Tubi: laccato goffrato moka.

Base units d 49 1/4"

Structures: grey lavagna melamine.
 Doors, drawers and pull-out storage baskets: scotch brite steel Ronda.
 Sides: scotch brite steel, thickness 1/2".
 Top: scotch brite steel Barazza with support frame in embossed lacquer carbone.
 Plinths: embossed lacquer carbone.

Blade snack

Solid wood walnut canaletto.

Tall units d 25 1/4"

Structures: grey lavagna melamine.
 Doors: black 1303 frosted glass with black anodized aluminium frame.
 Sides: extralight black frosted glass 2303, thickness 1/2".
 Vertical channels: lacquer carbone.

Shaker d 4 3/4"

Structures: moka anodized aluminium.
 Back panels: walnut c.
 Bars: embossed lacquer moka.

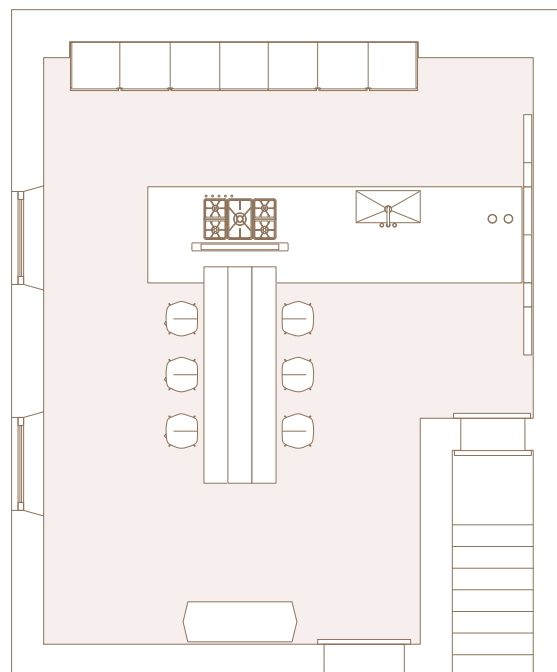
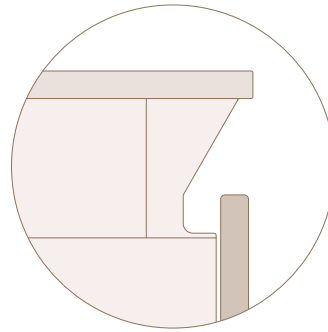

Basi Base units

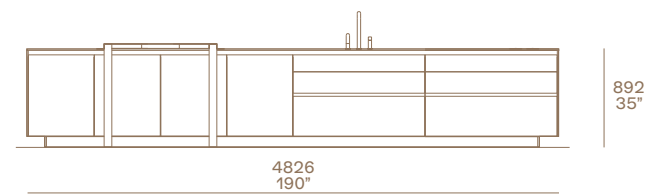
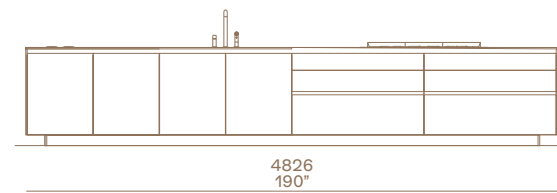

Shaker Shaker

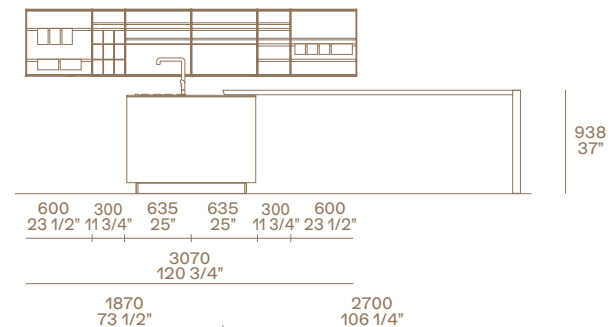

Colonne Tall units

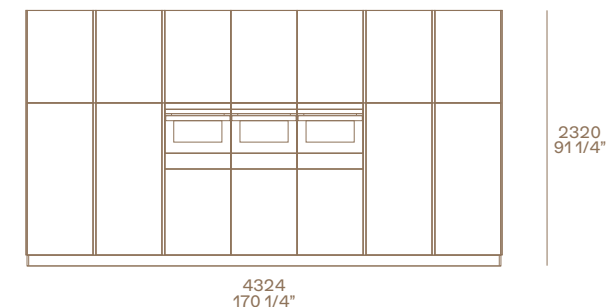

- 1 Piano cottura 5 fuochi in acciaio scotch brite saldato personalizzato Poliform by Barazza.
- 2 Lavello in acciaio scotch brite saldato.
- 3 Cappa Downdraft in acciaio scotch brite e vetro nero, finotop.

- 4 Attrezzatura in noce canaletto per estrattori.
- 5 Attrezzatura in noce canaletto e alluminio anodizzato moka per cassetti.
- 6 Piano snack Blade 2700 x 1022 mm.
- 7 Shaker con ripiani, vani a giorno, portabicchieri e contenitori.

- 8 Colonne con forno e scaldavivande con ante ad apertura battente ed estrattori.
- 9 Cassetti interni in noce canaletto.

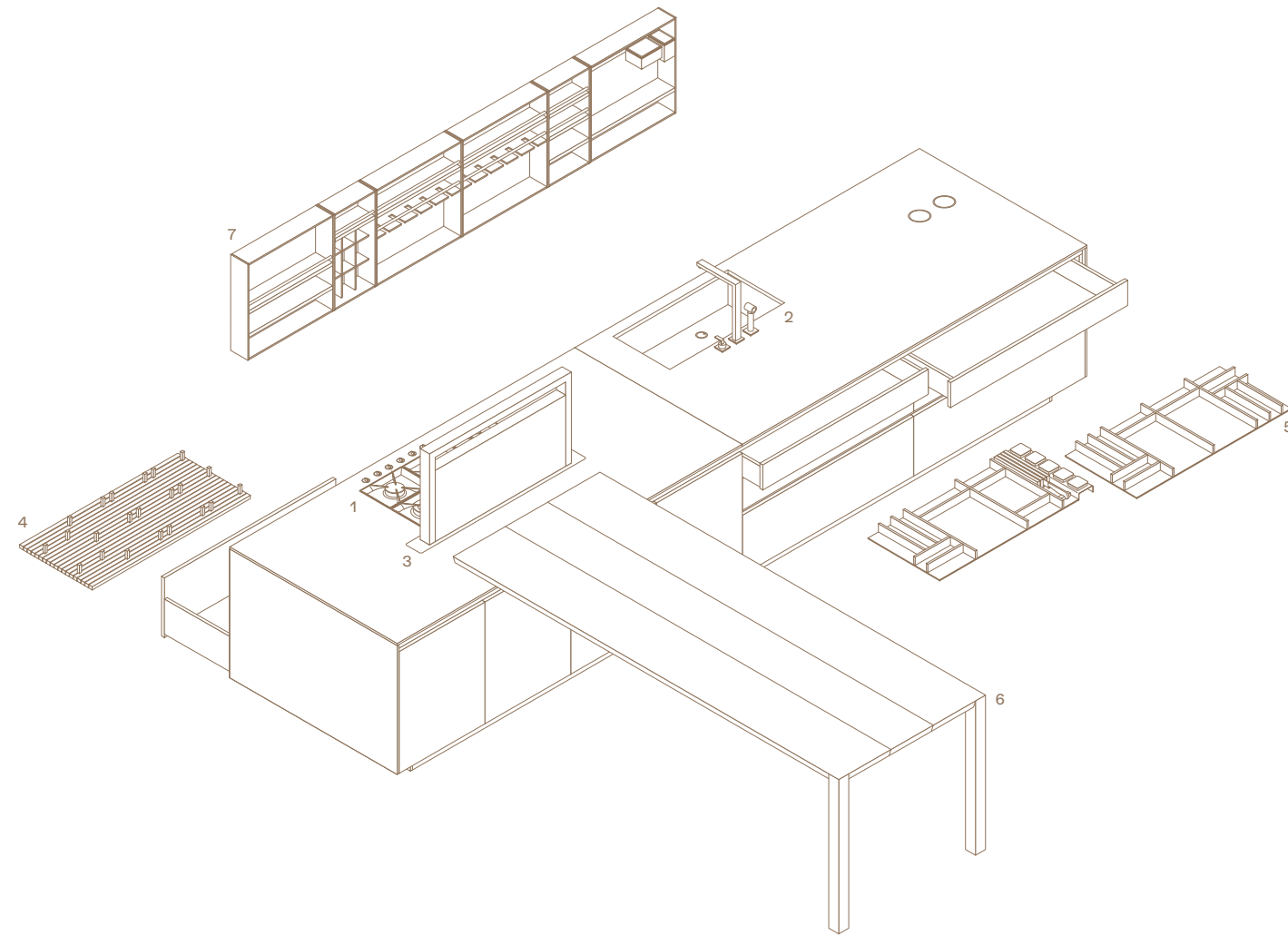

- 1 Personalized soldered hob in scotch brite steel with 5 burners Poliform by Barazza.
- 2 Soldered sink in scotch brite steel.
- 3 Downdraft hood in scotch brite steel and black glass, flush built-in.

- 4 Equipment in walnut canaletto for pull-out storage baskets.
- 5 Equipment in walnut canaletto and moka anodized aluminium for drawers.
- 6 Blade snack table 106 1/4" x 40 1/4".
- 7 Shaker with shelves, open compartments, glass racks and containers.

- 8 Tall units with oven and plate warmer, with leaf doors and pull-out storage baskets.
- 9 Inner drawers in walnut canaletto.

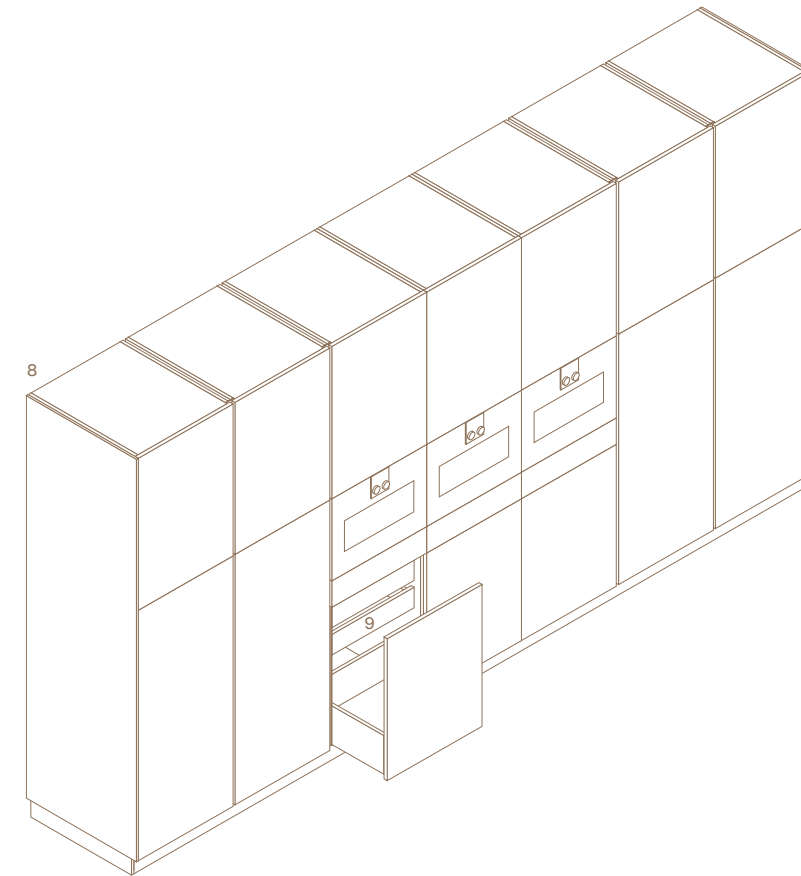

TECHNICAL DATA

CARATTERISTICHE DEI MODELLI CHARACTERISTICS OF THE MODELS	404
VETRINE SHOWCASES	414
ATTREZZATURA CASSETTI DRAWERS EQUIPMENT	416
ATTREZZATURA ESTRATTORI PULL-OUT BASKETS EQUIPMENT	417
COLONNE ATTREZZATE EQUIPPED TALL UNITS	418
VANI ATTREZZATI EQUIPPED UNITS	419
SOLUZIONI PER ANGOLI CORNER SOLUTIONS	420
COLONNE HIGH HIGH TALL UNITS	421
ELEMENTI A GIORNO OPEN UNITS	422
SHAKER SCHIENALI MODULARI SHAKER MODULAR BACKS	423
SISTEMA DEEP SHAKER DEEP SHAKER SYSTEM	424
LAVELLI SINKS	426
PIANI COTTURA HOBS	427
CAPPE HOODS	428
PORTARIFIUTI E BASI LAVELLO WASTEBINS AND SINK BASE UNITS	430
SOLUZIONI DI ILLUMINAZIONE LIGHTING SOLUTIONS	431
PIANI SNACK SNACK TABLES	432
FINITURE FINISHINGS	434

SHAPE

Design R&D Poliform

Spessore anta

26 mm.

Bordo apertura con modanatura e maniglia integrata.
Maniglia centrale l 180, 357 mm.

Finiture anta

Laccato goffrato colori.
Laccato opaco colori.
Essenza.
Laccato metallico colori.
Laccato lucido colori.
Massello.
Acciaio scotch brite.

Finiture maniglia

Laccato metallico bronzo.
Laccato opaco moka.

Door thickness

26 mm - 1".

Opening edge with moulding and integrated handle.
Central handle 7", 14".

Door finishings

Embossed lacquered colours.
Mat lacquered colours.
Wood.
Metal lacquered colours.
Glossy lacquered colours.
Solid wood.
Steel scotch brite.

Handle finishings

Bronzo metal lacquer.
Moka mat lacquer.

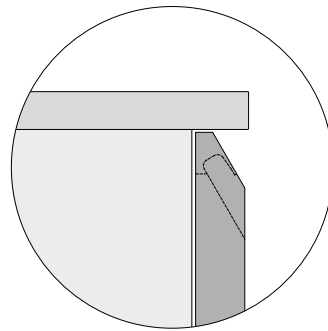

Spessore anta

26 mm.

Bordo apertura con modanatura e maniglia integrata.
Maniglia con verso l 177 mm.

Door thickness

26 mm - 1".

Opening edge with moulding and integrated handle.
Terminal handle w 7".

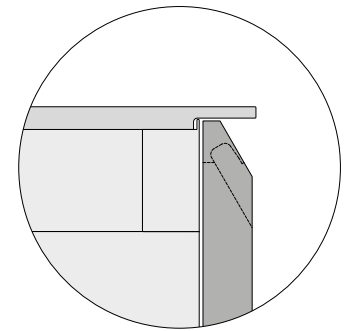

ARTEX
Design R&D Poliform

Anta a doghe
Spessore anta
26 mm.
Bordo apertura sagomato 60°.

Finiture anta
Laccato goffrato colori.
Laccato opaco colori.
Essenza.

Door with carved lines
Door thickness
26 mm - 1".
Shaped opening edge 60°.

Door finishings
Embossed lacquered colours.
Mat lacquered colours.
Wood.

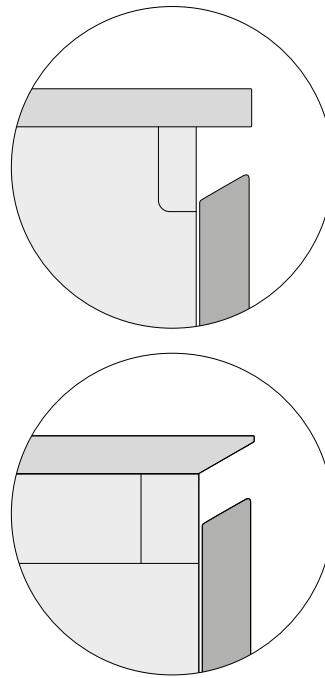

Anta liscia
Spessore anta
26 mm.
Bordo apertura sagomato 60°.

Finiture anta
Laminato opaco colori.
Laminato opaco touch colori.
Laccato goffrato colori.
Laccato opaco colori.
Essenza.
Laccato metallico colori.
Laccato lucido colori.
Massello.
Acciaio scotch brite.

Flat door
Door thickness
26 mm - 1".
Shaped opening edge 60°.

Door finishings
Mat laminate colours.
Mat laminate touch colours.
Embossed lacquered colours.
Mat lacquered colours.
Wood.
Metal lacquered colours.
Glossy lacquered colours.
Solid wood.
Steel scotch brite.

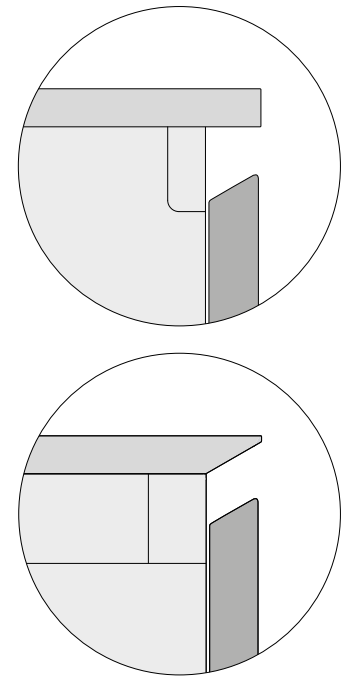

PHOENIX
Design R&D Poliform

Spessore anta
26 mm.
Bordo apertura con lavorazione a scasso.

Finiture anta
Laccato goffrato colori.
Laccato opaco colori.
Essenza.
Laccato metallico colori.
Laccato lucido colori.
Massello.
Acciaio scotch brite.

Door thickness
26 mm - 1".
Opening edge with reduced thickness.

Door finishings
Embossed lacquered colours.
Mat lacquered colours.
Wood.
Metal lacquered colours.
Glossy lacquered colours.
Solid wood.
Steel scotch brite.

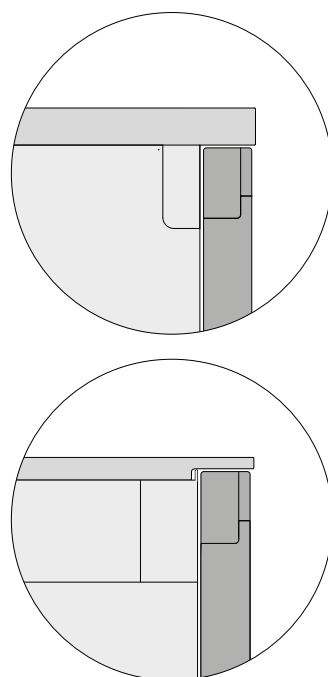

ALEA PRO
Design R&D Poliform

Spessore anta
22 mm.
Bordo apertura rastremato 55°.

Finiture anta
Laminato opaco e opaco touch colori.
Nobilitato.
LCT colori.
Laccato goffrato colori.
Laccato opaco colori.
STM colori.
Essenza.
Massello fresato.
Laccato metallico colori.
Laccato lucido colori.
Laminato satinato touch colori.
Vetro satinato e lucido colori.
Inalco MDi®.
Acciaio scotch brite.
Acciaio PVD colori.

Ante massello fresato, vetro e Inalco MDi® con telaio di supporto e profilo maniglia solo in alluminio anodizzato moka, pannello posteriore in tinta. Ante acciaio con bordo apertura rastremato senza profilo maniglia.

Finiture profilo maniglia
Anodizzato naturale.
Anodizzato champagne.
Anodizzato moka.

Door thickness
22 mm - 3/4".
55° chamfered opening edge.

Door finishings
Mat laminate and laminate touch colours.
Melamine.
LCT colours.
Embossed lacquered colours.
Mat lacquered colours.
STM colours.
Wood.
Milled solid wood.
Metal lacquered colours.
Glossy lacquered colours.
Satin laminate touch colours.
Etched and glossy glass colours.
Inalco MDi®.
Steel scotch brite.
PVD steel colours.

Doors in milled solid wood, glass and Inalco MDi® with support frame and handle profile only in anodized aluminium moka, rear panel in matching colour. Doors in steel with tapered opening edge without handle profile.

Handle profile finishings
Anodized natural.
Anodized champagne.
Anodized moka.

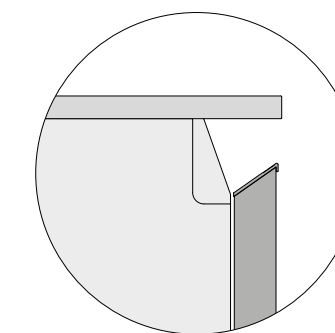

ALEA

Design R&D Poliform

Spessore anta

22 mm.

Finiture anta

Laminato opaco colori.
Nobilitato.
Laminato opaco touch colori.
LCT colori.
Laccato goffrato colori.
Laccato opaco colori.
STM colori.
Essenza.
Laccato metallico colori.
Laccato lucido colori.
Laminato satinato touch colori.
Vetro satinato colori.
Vetro lucido colori.
Acciaio scotch brite.
Acciaio PVD colori.

Ante vetro con telaio di supporto
in alluminio anodizzato naturale
o anodizzato nero.

Door thickness

22 mm - 3/4".

Door finishings

Mat laminate colours.
Melamine.
Mat laminate touch colours.
LCT colours.
Embossed lacquered colours.
Mat lacquered colours.
STM colours.
Wood.
Metal lacquered colours.
Glossy lacquered colours.
Satin laminat touch colours.
Etched glass colours.
Glossy glass colours.
Steel scotch brite.
PVD steel colours.

Glass doors with supporting frame
in anodized natural or black anodized
aluminium.

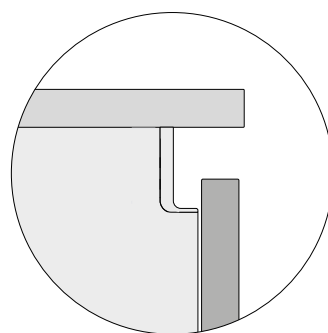

TWELVE

Design Carlo Colombo and R&D Poliform

Spessore anta

12 mm.

Finiture anta

Laminato opaco colori.
Laminato opaco touch colori.
Laccato goffrato colori.
Laccato opaco colori.
Essenza.
Laccato metallico colori.
Laccato lucido colori.
Vetro satinato colori.
Vetro lucido colori.
Acciaio scotch brite.
Acciaio PVD colori.

Ante vetro con telaio di supporto
in alluminio anodizzato naturale
o anodizzato nero.

Door thickness

12 mm - 1/2".

Door finishings

Mat laminate colours.
Mat laminate touch colours.
Embossed lacquered colours.
Mat lacquered colours
Wood.
Metal lacquered colours.
Glossy lacquered colours.
Etched glass colours.
Glossy glass colours.
Steel scotch brite.
PVD steel colours.

Glass doors with supporting frame
in anodized natural or black anodized
aluminium.

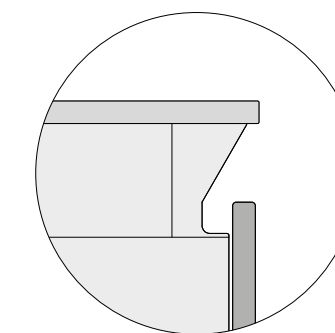

MY PLANET
Design R&D Poliform

Anta con maniglia integrata
Spessore anta
22 mm.

Finiture anta
Laminato opaco colori.
Nobilitato.
Laminato opaco touch colori.
LCT colori.
Laccato goffrato colori.
Laccato opaco colori.
STM colori.
Essenza.
Laccato metallico colori.
Laccato lucido colori.
Laminato satinato touch colori.

Finiture maniglia
Laccato goffrato colori.
Laccato opaco colori.
Laccato STM colori.
Laccato silk perla, bronzo, grey.
Laccato opaco alluminio e acciaio.

Door with integrated handle
Door thickness
22 mm - 3/4".

Door finishings
Mat laminate colours.
Melamine.
Mat laminate touch colours.
LCT colours.
Embossed lacquered colours.
Mat lacquered colours.
STM colours.
Wood.
Metal lacquered colours.
Glossy lacquered colours.
Satin laminate touch colours.

Handle finishings
Embossed lacquered colours.
Mat lacquered colours.
STM lacquered colours.
Perla, bronzo, grey silk lacquer.
Aluminium, steel and titanio mat lacquer.

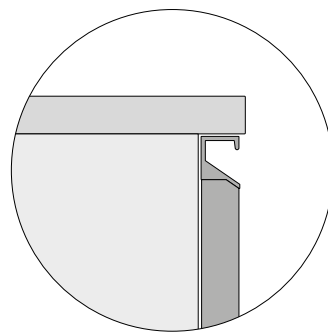

Anta con maniglia applicata
Spessore anta
22 mm.
2 modelli di maniglie.

Finiture anta
Laminato opaco colori.
Nobilitato.
Laminato opaco touch colori.
LCT colori.
Laccato goffrato colori.
Laccato opaco colori.
STM colori.
Essenza.
Laccato metallico colori.
Laccato lucido colori.
Laminato satinato touch colori.
Acciaio scotch brite.
Acciaio PVD colori.

Door with applied handle
Door thickness
22 mm - 3/4".
2 handles available.

Door finishings
Mat laminate colours.
Melamine.
Mat laminate touch colours.
LCT colours.
Embossed lacquered colours.
Mat lacquered colours.
STM colours.
Wood.
Metal lacquered colours.
Glossy lacquered colours.
Satin laminate touch colours.
Steel scotch brite.
PVD steel colours.

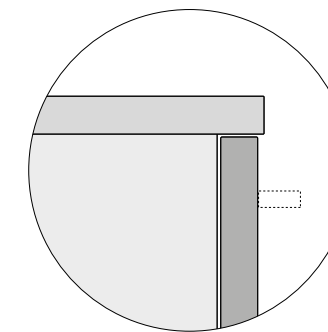

VETRINE SHOWCASES

PR24

Spessore 24 mm.
Anta in vetro riflettente 5059 fumé con telaio in alluminio anodizzato champagne o moka.
Per basi anta con telaio superiore sagomato a 55° come anta Alea Pro.
Per pensili apertura con profilo sottopensile.
Per colonne apertura con maniglia integrata verniciato champagne o moka.
Per elementi sopra colonna apertura tip-on.
Thickness 24 mm - 1".
Door in fumé reflective glass 5059 with frame in moka or champagne anodized aluminium.
For base units, door with 55° shaped upper frame like Alea Pro door.
For wall units opening with finger-pull profile.
For tall units opening with integrated handle painted champagne or moka.
For elements above tall unit, tip-on opening.



PR22

Spessore 20 mm.
Anta in vetro riflettente 5059 fumé con telaio in alluminio anodizzato nero.
Per pensili apertura con profilo sottopensile.
Per colonne apertura con gola verticale o con maniglia integrata verniciato nero.
Per elementi sopra colonna apertura con gola verticale o apertura tip-on.
Thickness 20 mm - 3/4".
Door in fumé reflective glass 5059 with black anodized aluminium frame.
For wall units opening with finger-pull profile.
For tall units opening with vertical channel or with black painted integrated handle.
For elements above tall unit, opening with vertical channel or tip-on opening.



PR19

Spessore 26 mm.
Anta in vetro riflettente 5051 bronzato con telaio in alluminio verniciato bronzo.
Per pensili apertura con profilo sottopensile o apertura tip-on.
Thickness 26 mm - 1".
Door in bronzed reflective glass 5051 with frame in bronzo painted aluminium.
For wall units opening with finger-pull profile or tip-on opening.



PR21

Spessore 26 mm.
Anta in vetro riflettente 5059 fumé con telaio in alluminio anodizzato moka.
Per pensili apertura con profilo sottopensile.
Per colonne apertura con maniglia integrata verniciato moka.
Per elementi sopra colonna apertura tip-on.
Thickness 26 mm - 1".
Door in fumé reflective glass 5059 with anodized moka aluminium frame.
For wall units opening with finger-pull profile.
For tall units opening with moka painted integrated handle.
For elements above tall unit, tip-on opening.



ATTREZZATURA CASSETTI DRAWERS EQUIPMENT

Tipologie

- 1 Cassetti.
- 2 Cassetti interni per estrattore.
- 3 Cassetti interni per anta battente.
- 4 Cassetti interni per anta vetrina PR24.

Accessori

Portaposate, portacoltelli, bilancia elettronica, tagliere per pane, portaspezie in ceramica, vaschette in acciaio, set macinaspezie, portapellucole, portamattarello.

Types

- 1 Drawers.
- 2 Inner drawers for pull-out basket.
- 3 Inner drawers for leaf door.
- 4 Inner drawers for glass door PR24.

Accessories

Cutlery tray, knife-rack, electronic scale, chopping board for bread, ceramic spice-holder, steel basins, spice grinder set, protective-film rack, rolling pin-holder.

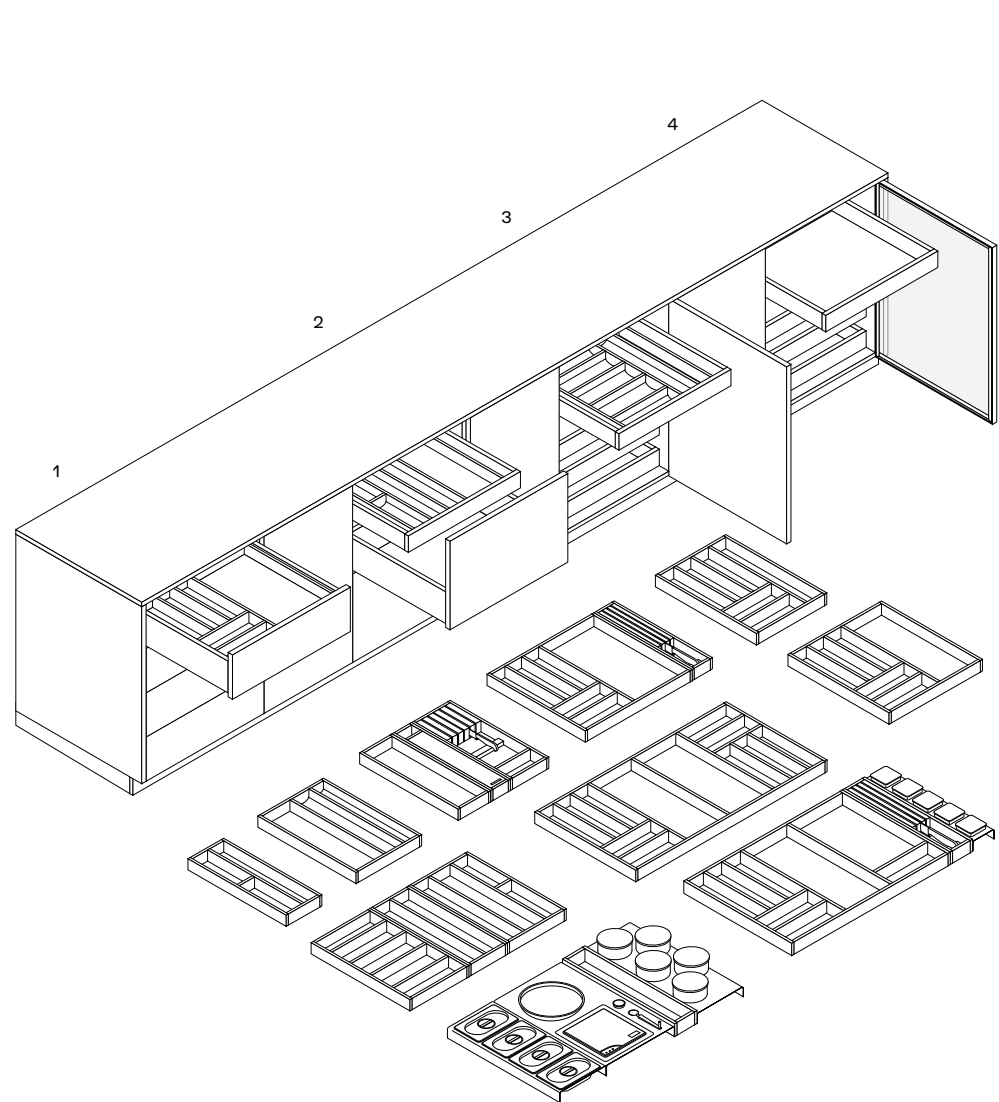

Attrezzature Equipment



Wengé
Wenge



Noce canaletto
Walnut canaletto



Laminato military touch
Laminate military touch



Alluminio
Aluminium



Materiale plastico
atossico antracite
Non-toxic plastic
colour anthracite

ATTREZZATURA ESTRATTORI PULL-OUT BASKETS EQUIPMENT

Tipologie

- 1 Estrattori.
- 2 Estrattori interni per estrattore.
- 3 Estrattori interni per anta battente.
- 4 Estrattori interni per anta vetrina PR24.

Accessori

Piattaia, portapiatti regolabile, portapane in terracotta, portarotolo, contenitori in ceramica.

Types

- 1 Pull-out baskets.
- 2 Inner pull-outs for pull-out basket.
- 3 Inner pull-outs for leaf door.
- 4 Inner pull-outs for glass door PR24.

Accessories

Plate-rack, adjustable plate-rack, clay bread container, rolling pin-holder, ceramic holders.

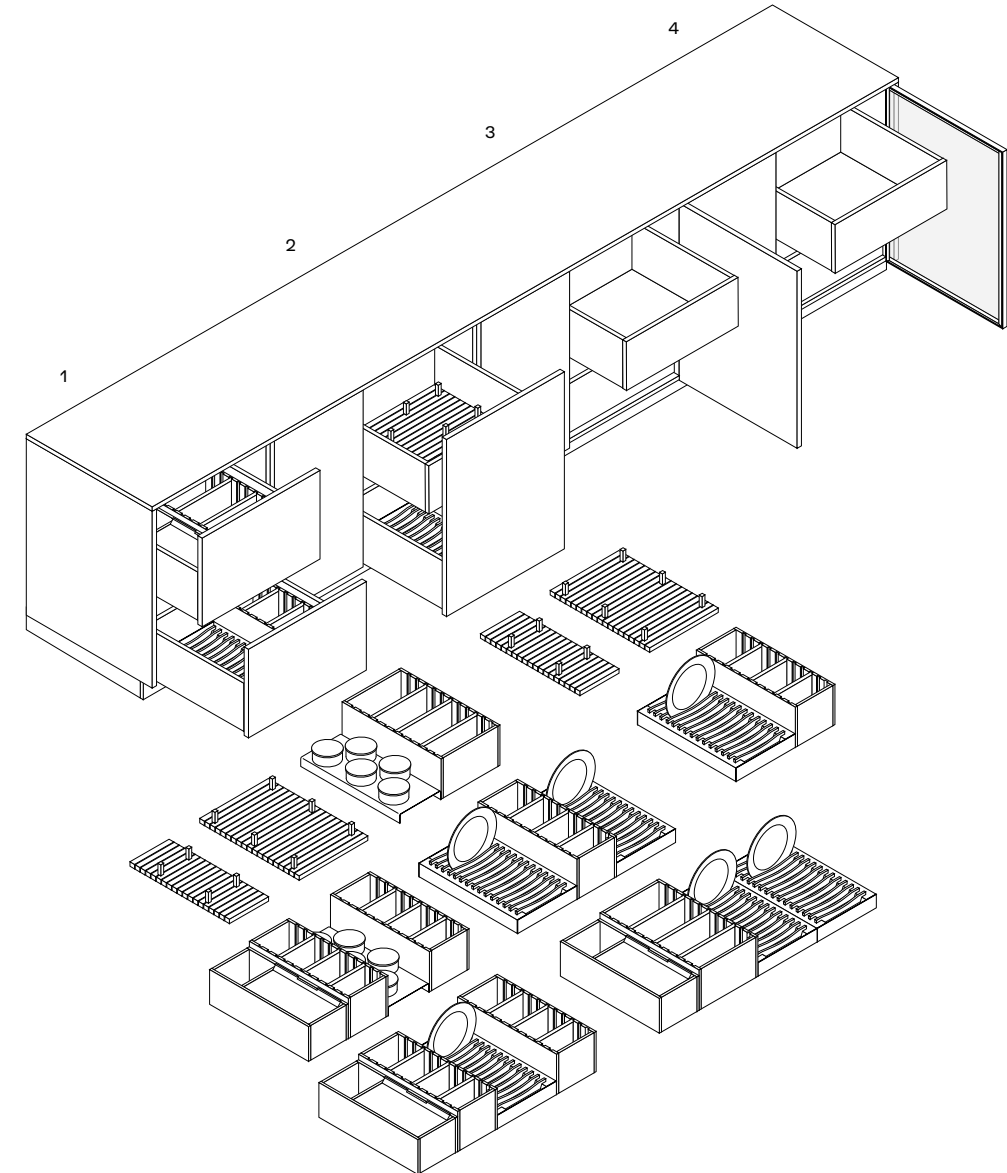

Attrezzature Equipment



Wengé
Wenge



Noce canaletto
Walnut canaletto



Laminato military touch
Laminate military touch



Alluminio
Aluminium

COLONNE ATTREZZATE EQUIPPED TALL UNITS

Tipologie

- 1 Colonna con meccanismo estraibile Tandem Side.
- 2 Colonna con struttura estraibile Convoy Lavido.
- 3 Colonna attrezzata con ganci portascoppe e cestelli.
- 4 Colonna con struttura estraibile e cestelli.
- 5 Colonna con struttura estraibile Convoy Centro.
- 6 Colonna con struttura estraibile, con estrattori e cassette interni.

Types

- 1 Tall unit with pull-out mechanism Tandem Side.
- 2 Tall unit with pull-out structure Convoy Lavido.
- 3 Tall unit equipped with broom hooks and baskets.
- 4 Tall unit with pull-out structure and baskets.
- 5 Tall unit with pull-out structure Convoy Centro.
- 6 Tall unit with pull-out structure, pull-out storage baskets and inner drawers.

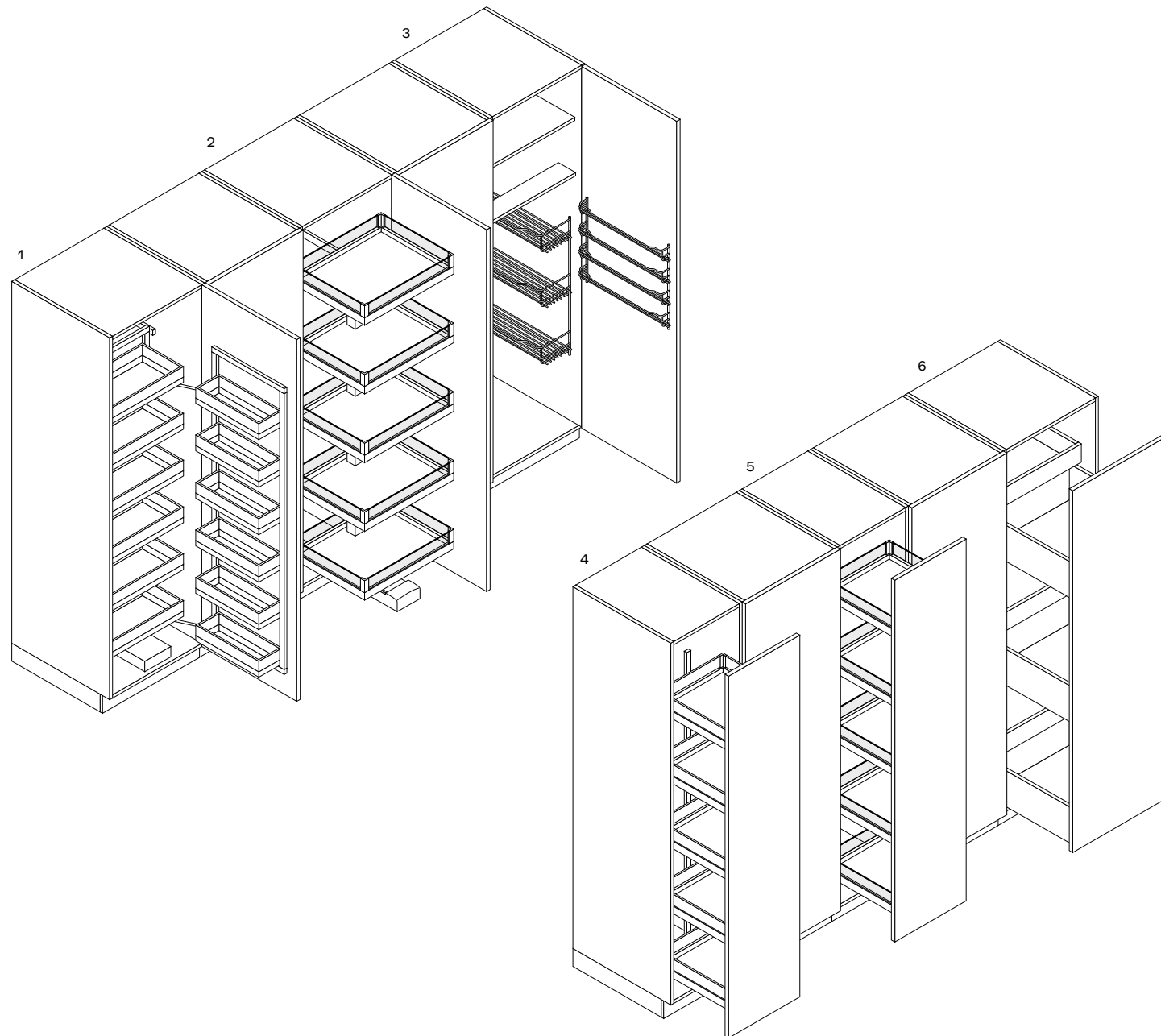

VANI ATTREZZATI EQUIPPED UNITS

Tipologie

- 1 Ante battenti apertura totale.
- 2 Ante a scomparsa.

Attrezzature

Piano di lavoro estraibile in acciaio, cassetti interni, ripiani, ripiani in vetro, Shaker, barra con luci a led e presa elettrica.

Types

- 1 Total opening leaf doors.
- 2 Pocket doors.

Equipment

Pull-out worktop in steel, inner drawers, shelves, glass shelves, Shaker, bar with led lights and electric socket.

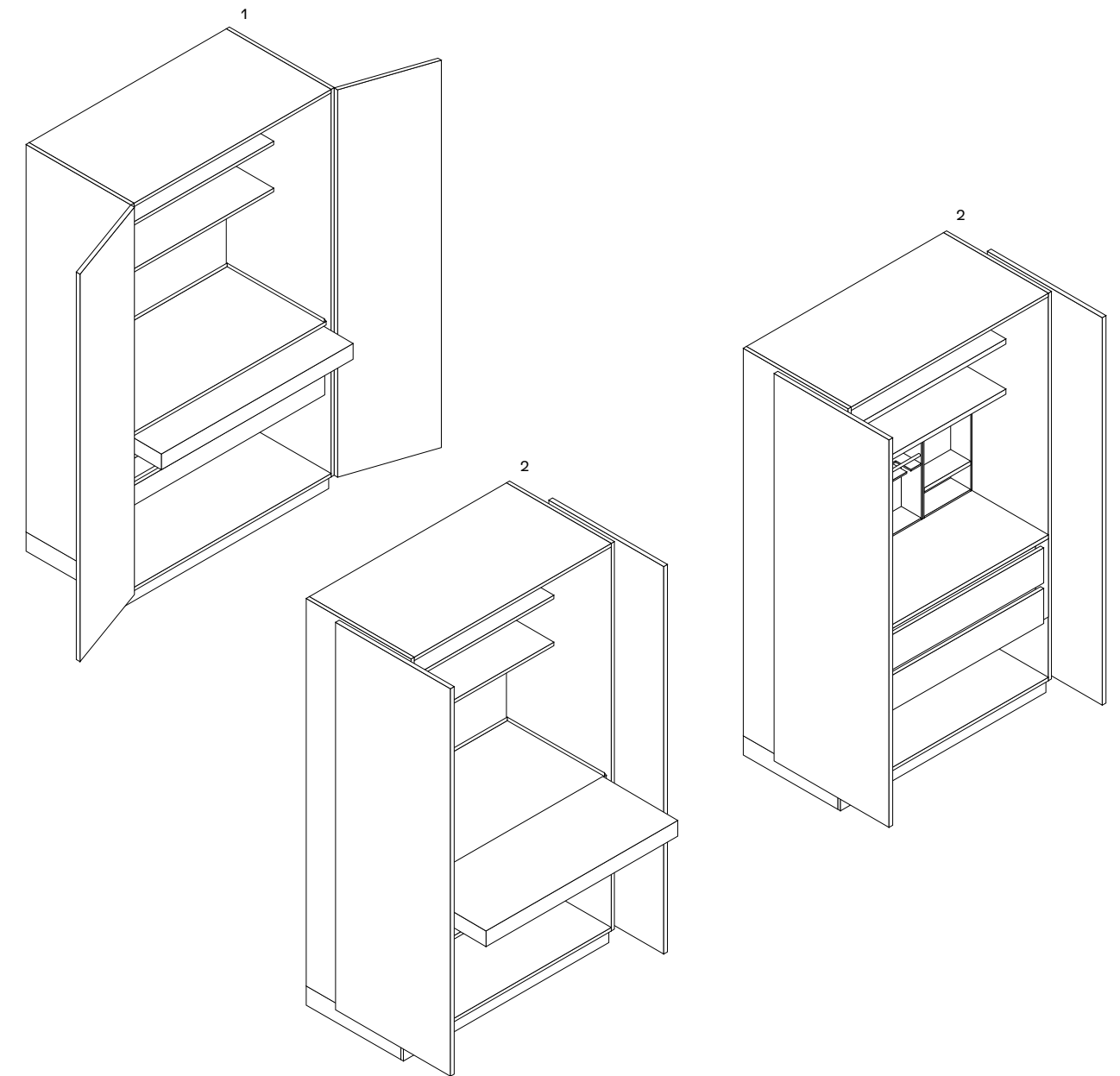

SOLUZIONI PER ANGOLI CORNER SOLUTIONS

Basi

- 1 Base angolare, doppia anta battente.
- 2 Base angolo, anta battente.

Pensili

- 3 Pensile angolo.
- 4 Pensile angolare, anta a libro.
- 5 Pensile angolare, doppia anta battente.

Colonne

- 6 Colonna angolare, doppia anta battente.
- 7 Colonna angolo, anta battente.

Attrezzature

- 8 Cesti estraibili Le Mans II.

Base units

- 1 Corner base unit, double leaf door.
- 2 Corner base unit, leaf door.

Wall units

- 3 Corner wall unit.
- 4 Corner wall unit, folding door.
- 5 Corner wall unit, double leaf door.

Tall units

- 6 Corner tall unit, double leaf door.
- 7 Corner tall unit, leaf door.

Equipments

- 8 Pull-out storage baskets Le Mans II.

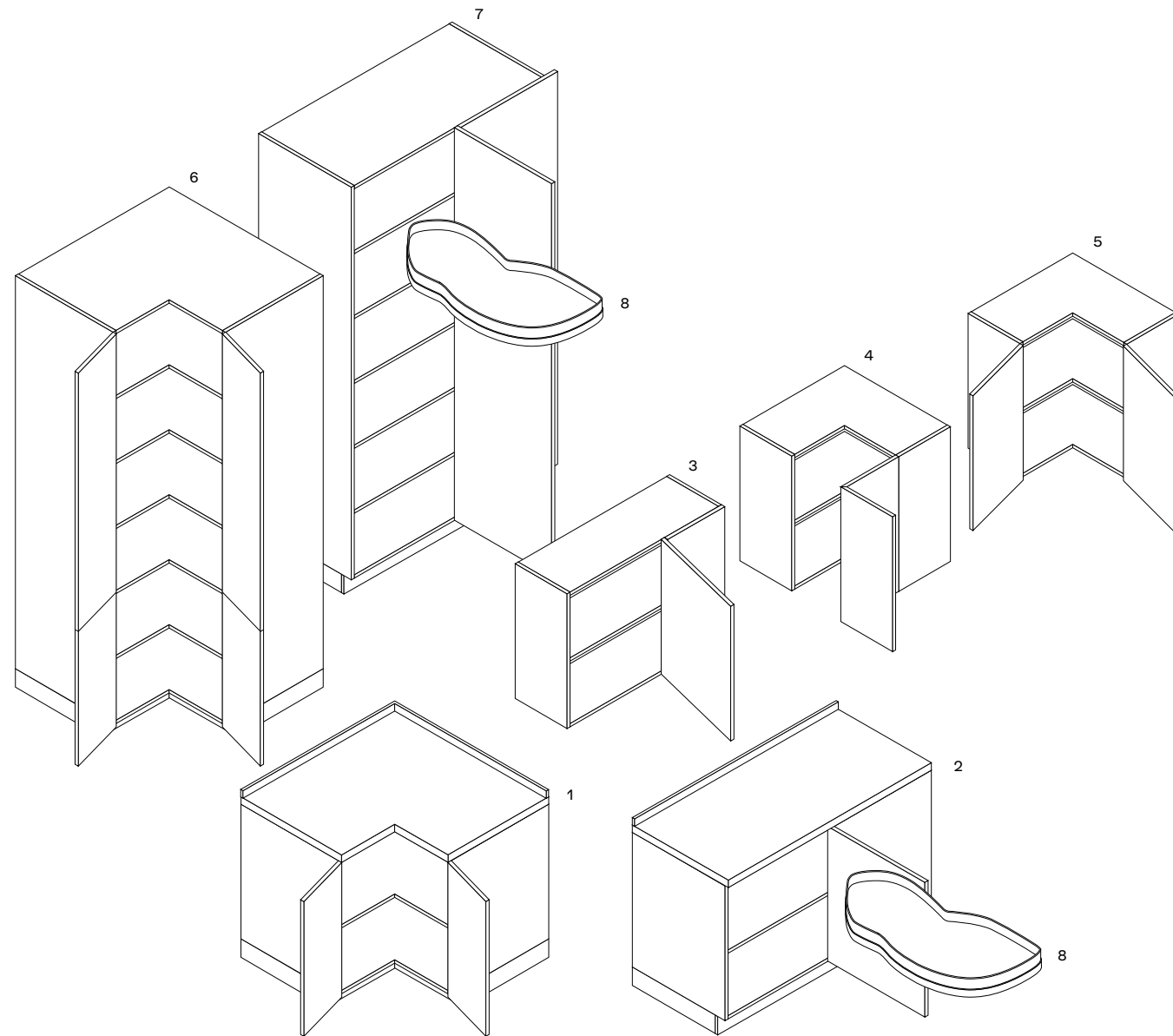

COLONNE HIGH HIGH TALL UNITS

Le colonne High si ottengono con la sovrapposizione di una colonna con un elemento sopra colonna e il montaggio di un'anta intera (battente escluso vetrina, ad apertura totale o a scomparsa) o di ante divise (battente, cassetti ed estrattori). Nel caso di ante divise, il taglio delle ante è situato sempre nella parte inferiore, a 780 o 840 mm dal filo inferiore della colonna. Anta intera non disponibile nella versione in massello.

- 1 Colonna High con anta battente intera, disponibile anche divisa.
- 2 Colonna High con anta ad apertura totale intera, disponibile anche divisa.
- 3 Colonna High con anta a scomparsa.

High tall units are obtained by overlapping one tall unit with an above-tall-unit-element and the installation of a full height door (with leaf opening, except glass door, full opening or pocket doors) or divided door (leaf, drawers and pull-out baskets). In case of split doors, the cut of the doors is always in the lowest part, at height 30 3/4" or 33" from the lower edge of the tall unit. Full height door not available in the solid wood version.

- 1 High tall unit with full height door, available also split.
- 2 Tall unit with full opening door in one piece, available also split.
- 3 High tall unit with pocket doors.

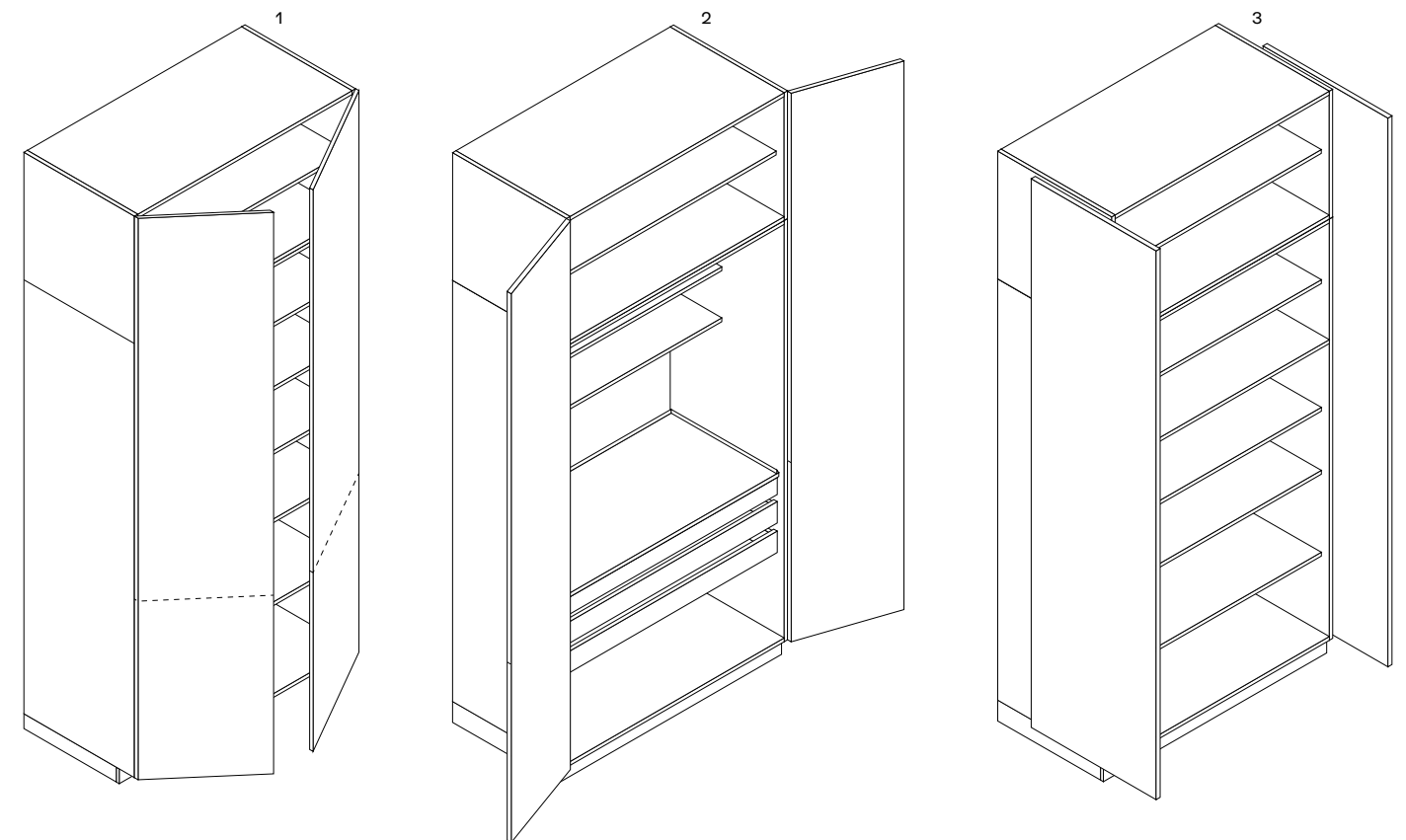

ELEMENTI A GIORNO OPEN UNITS

Tipologie

- 1 Elementi a giorno per basi, pensili e colonne.
- 2 Elementi a giorno per colonne.
- 3 Elementi a giorno rastremati per basi, pensili e colonne.

Types

- 1 Open units for base, wall and tall units.
- 2 Open units for tall units.
- 3 Chamfered open units for base, wall and tall units.

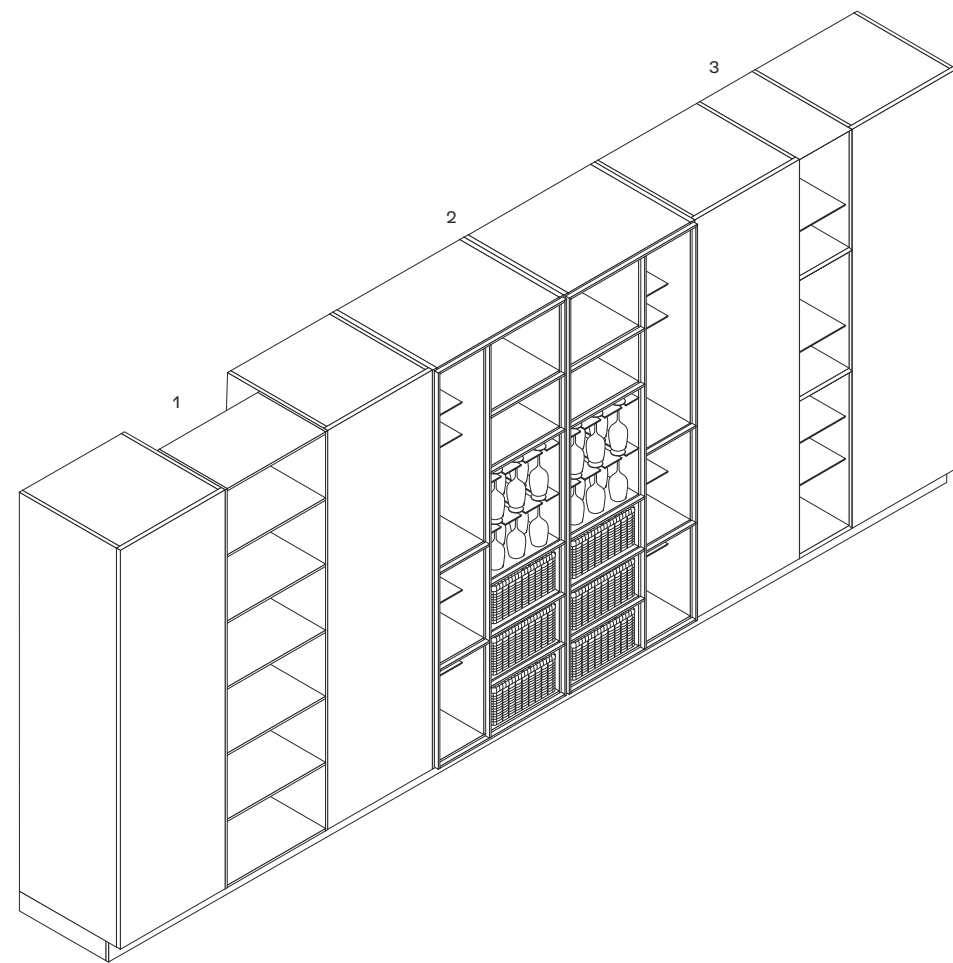

SHAKER SCHIENALI MODULARI SHAKER MODULAR BACKS

Profondità 120

Schienali modulari disponibili in diverse dimensioni e configurazioni.

Moduli larghezza da 300 a 1200.

- 1 Moduli sopratop h da 548 a 594, misure variabili in riferimento allo spessore del top.
- 2 Moduli a terra h 1380-1440.

Depth 4 3/4"

Modular backs available in different sizes and configurations.

Modules width from 11 3/4" to 47 1/4".

- 1 Modules placed on the top h from 21 1/2" to 23 1/2", variable measures according to the top thickness.
- 2 Floorstanding modules h 54 1/4"-56 3/4".

Attrezzature

Ripiani, tubi, contenitori in DuPont Corian®, griglia, porta bicchieri.

Accessories

Shelves, bars, containers in DuPont Corian®, grid, glass holders.

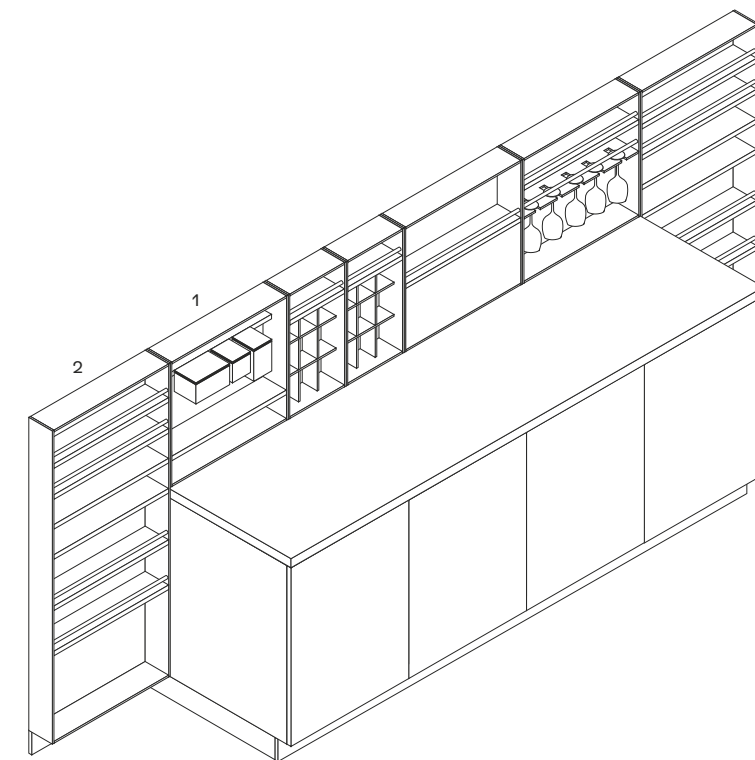

SISTEMA DEEP SHAKER DEEP SHAKER SYSTEM

Deep Shaker è un sistema versatile pensato per migliorare la funzionalità dei piani di lavoro e delle colonne.

- 1 Deep Shaker**
Elementi modulari monofacciali con schienale. Moduli sopra top e a terra da completare con fascia zoccolo.
- 2 Deep Shaker Wall**
Elementi modulari monofacciali con schienale per l'inserimento tra le colonne.
- 3 Deep Shaker Plain**
Canale attrezzato per il piano di lavoro dell'isola.
- 4 Deep Shaker Move**
Sistema bifacciale a scomparsa per attrezzare il piano di lavoro dell'isola. Il piano superiore è realizzato nella stessa finitura del piano della cucina per risultare invisibile quando non viene utilizzato.
- 5 Deep Shaker Island**
Sistema bifacciale per attrezzare il piano di lavoro dell'isola. Moduli sopra top o a terra da completare con fascia zoccolo.

Deep Shaker is a versatile system designed to improve the functionality of the worktops and the tall units.

- 1 Deep Shaker**
Modular single-sided elements with back. Modules placed on the top and floorstanding to be completed with plinth filler.
- 2 Deep Shaker Wall**
Modular single-sided elements with back to be inserted between tall units.
- 3 Deep Shaker Plain**
Equipped channel for island worktop.
- 4 Deep Shaker Move**
Retractable double-sided system to equip the island worktop. The top shelf is in the same finish of the kitchen worktop to be invisible when not in use.
- 5 Deep Shaker Island**
Double-sided system to equip the island worktop. Modules placed on the top and floorstanding to be completed with plinth filler.

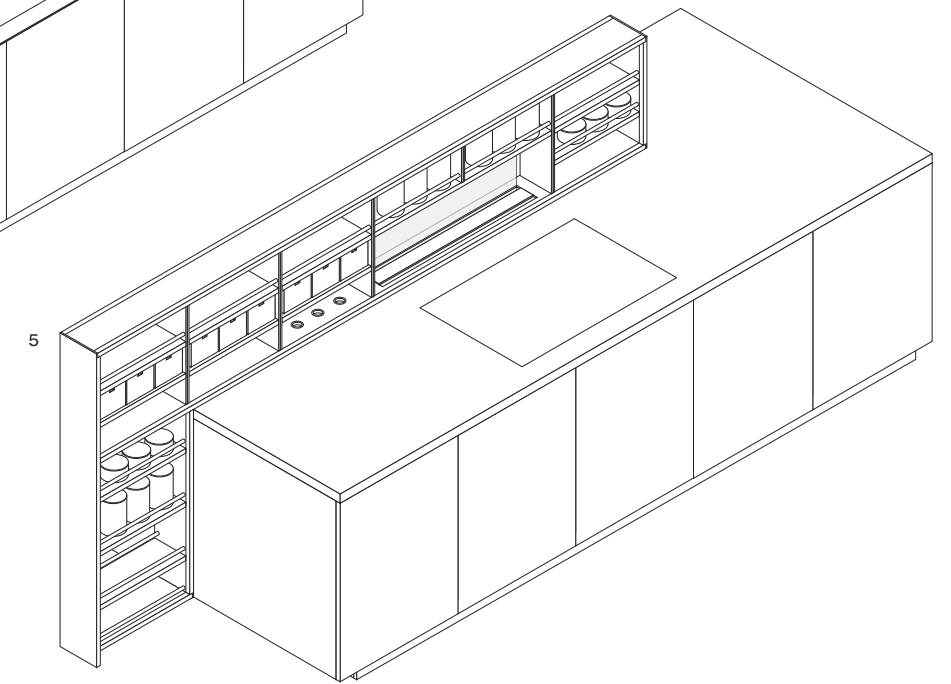
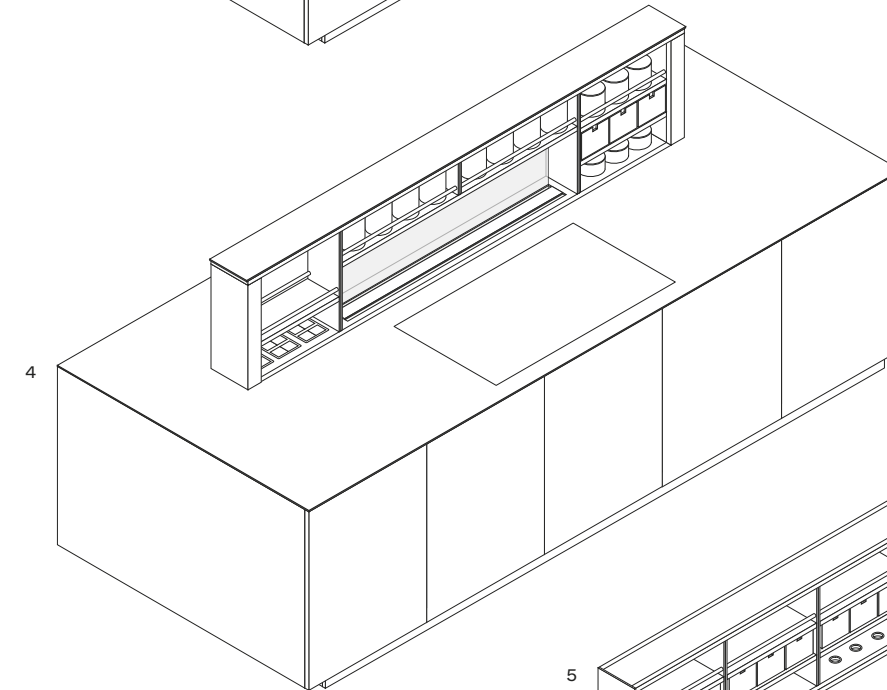
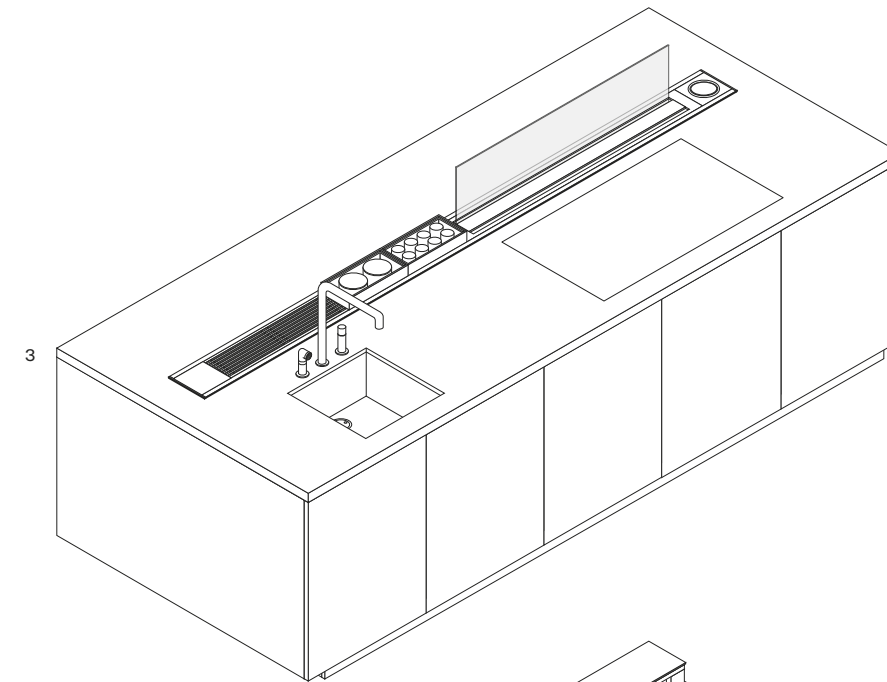
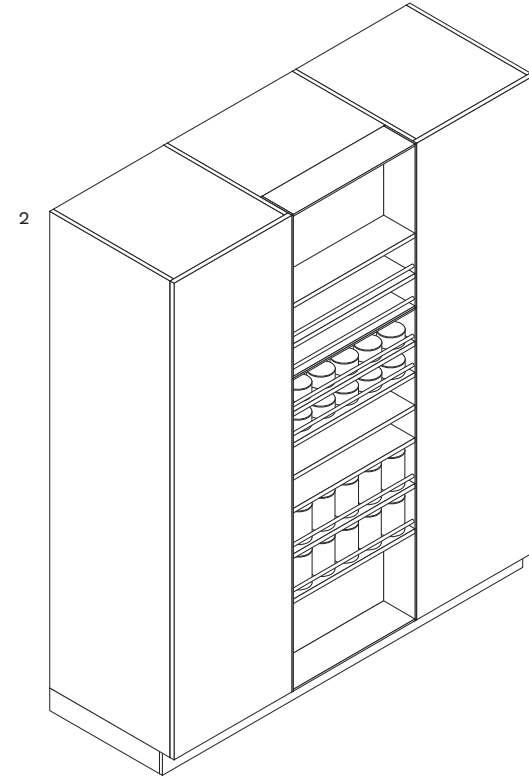
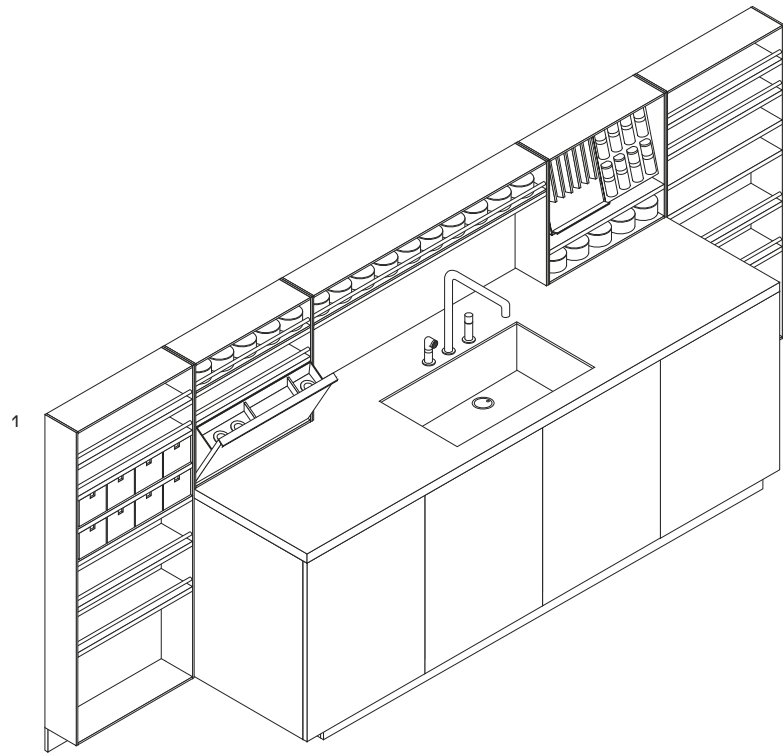

LAVELLI SINKS

Tipologie

- 1 Lavello integrato nel piano.
- 2 Lavello incassato nel piano.

Finiture lavelli integrati

Lavello e piano in laminato tuttocolore, laminato tuttocolore touch, Inalco MDi®, DuPont Corian®, dekton, acciaio.

Types

- 1 Sink integrated in the top.
- 2 Sink built-in in the top.

Sink integrated finishings

Sink and top in tuttocolore laminate, tuttocolore laminate touch, Inalco MDi®, DuPont Corian®, dekton, steel.

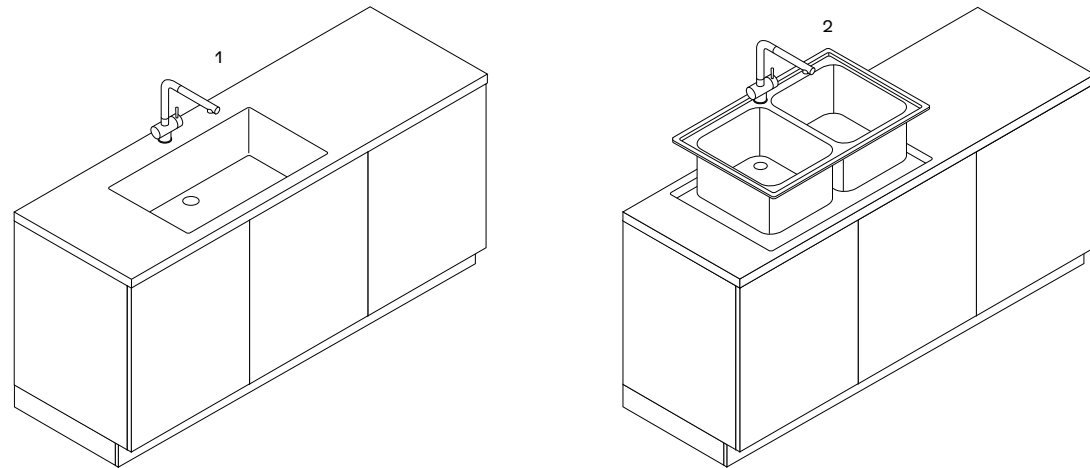

Tipologie di incasso Built-in types

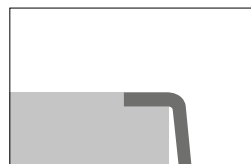

Filotop
Fully flush built-in

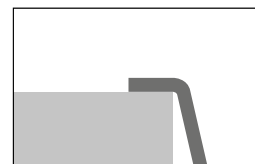

Finotop - h 1 mm
Flush built-in - h 5/128"



Appoggio - h 40 mm
Surface-mounted - h 1 1/2"

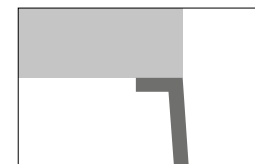

Sottotop
Under-top mounted



Appoggio
Surface-mounted

PIANI COTTURA HOBS

Tipologie

- 1 Piano a induzione.
- 2 Piano a induzione sottotop.
Top in Inalco MDi® induction
finitura stone brown.
- 3 Piano a gas.
- 4 Elementi modulari.

Types

- 1 Induction hob.
- 2 Undermount induction hob.
Top in Inalco MDi® induction
finish stone brown.
- 3 Gas hob.
- 4 Modular elements.

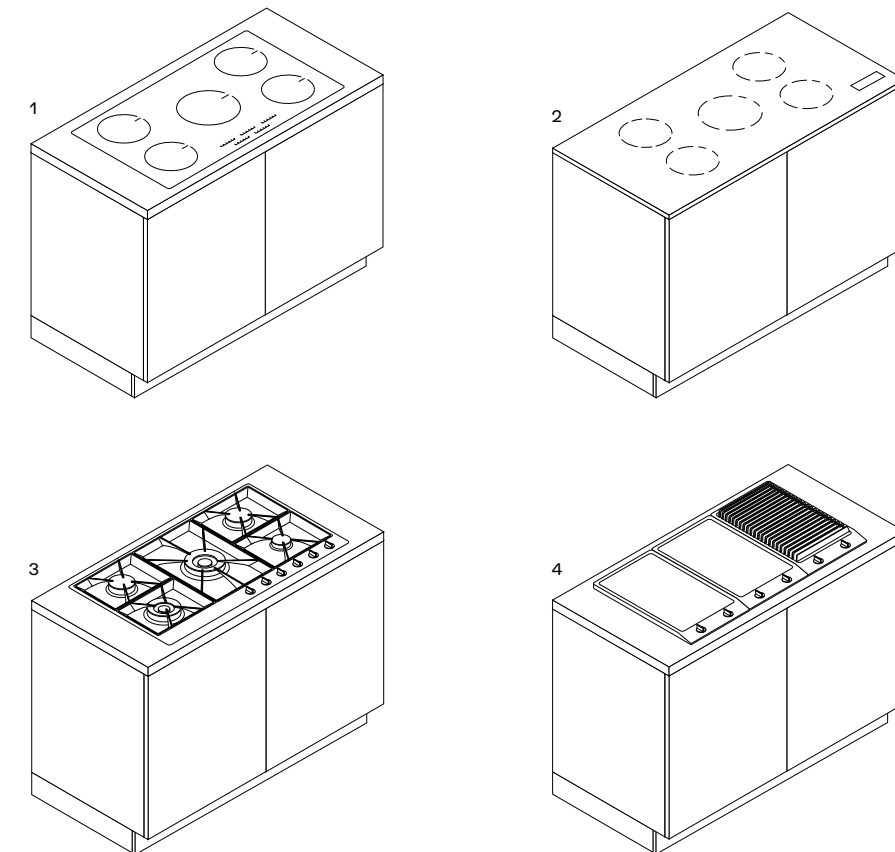

Tipologie di incasso Built-in types

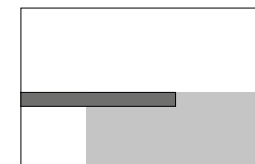

Filotop
Fully flush built-in

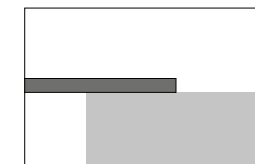

Finotop - h 1 mm
Flush built-in - h 5/128"

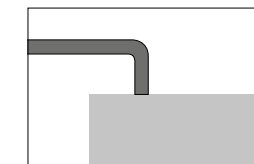

Appoggio
Surface-mounted

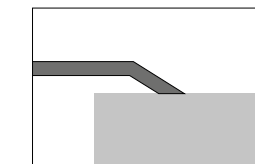

Semifilotop
Semi-flush built-in

CAPPE HOODS

Infinity, sistema modulare personalizzato Poliform

Moduli da assemblare per configurazioni a isola.

- 1 Modulo cappa aspirante.
- 2 Modulo fitostimolante con teca in vetro alta.
- 3 Modulo portaspezie con teca in vetro bassa o alta.
- 4 Modulo mensola.
- 5 Tiranti terminali.

Infinity, Poliform personalised modular system

Modules to be assembled for island configurations.

- 1 Extractor hood module.
- 2 Phyto-stimulant module with high glass case.
- 3 Spice rack module with low or high glass case.
- 4 Shelf module.
- 5 Terminal tie rods.

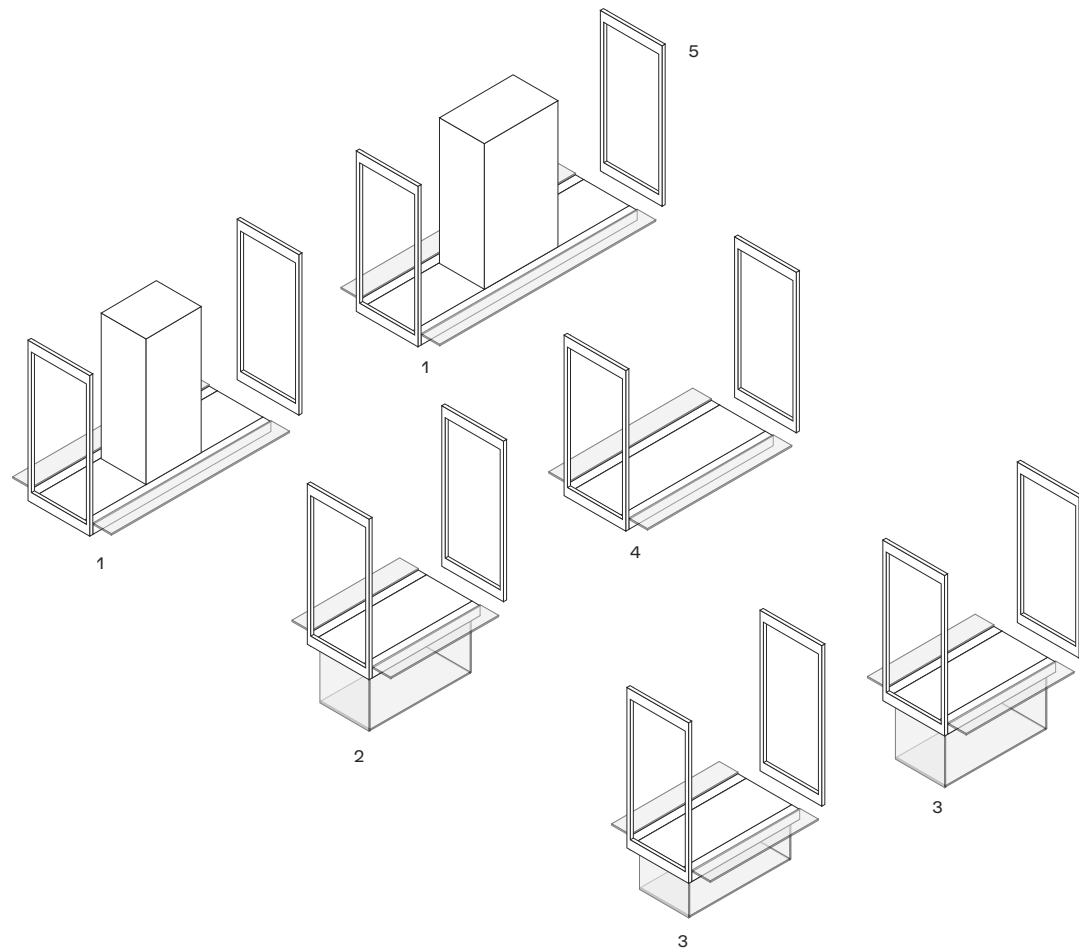

Cappe personalizzate Poliform

- 1 Piatta a parete e a isola.
- 2 Flat a parete e a isola.
- 3 Work a parete e a isola.
- 4 Box a parete e a isola.
- 5 Glass a isola.
- 6 Factory a isola.

Poliform personalised hoods

- 1 Piatta wall and island hood.
- 2 Flat wall and island hood.
- 3 Work wall and island hood.
- 4 Box wall and island hood.
- 5 Glass island hood.
- 6 Factory island hood.

Cappe integrate personalizzate Poliform

- 7 Fly integrata nel pensile.
- 8 Easy integrata nel pensile.
- 9 Cappa a scomparsa integrata nel pensile.
- 10 Cappa integrata nei sistemi Deep Shaker Move, Deep Shaker Island e Deep Shaker Plain.

Poliform personalised integrated hoods

- 7 Fly integrated in the wall unit.
- 8 Easy integrated in the wall unit.
- 9 Retractable hood integrated in the wall unit.
- 10 Integrated hood in the systems Deep Shaker Move, Deep Shaker Island and Deep Shaker Plain.

Cappe non personalizzate

- 11 Downdraft a scomparsa nel top.
- 12 Cappa a isola.

Non-personalized hoods

- 11 Downdraft retractable hood in the top.
- 12 Island hood.

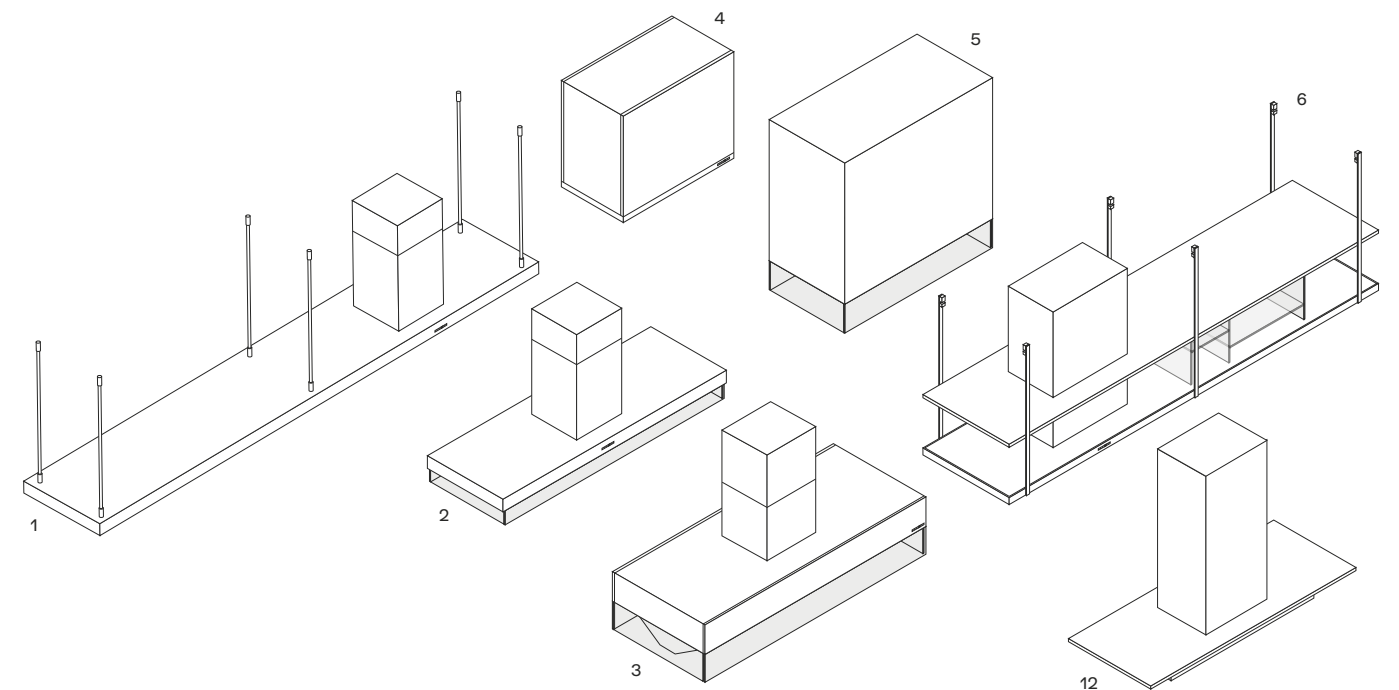

Cappe integrate da incasso Built-in integrated hoods

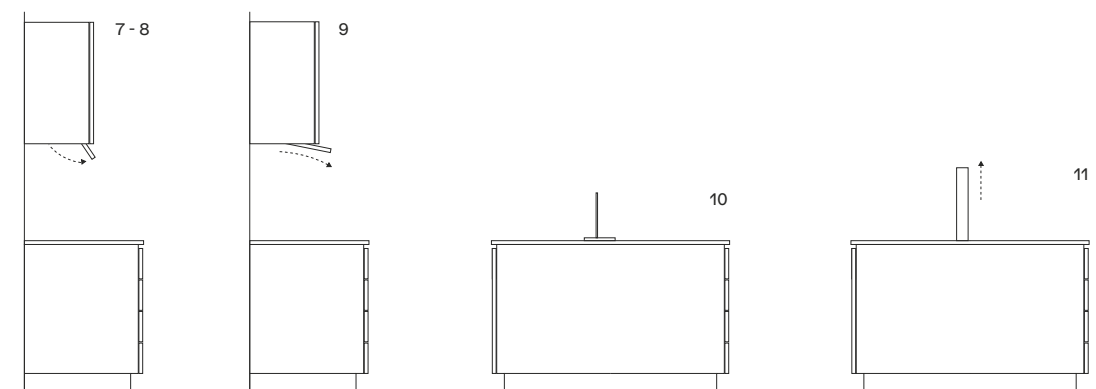

PORTARIFIUTI E BASI LAVELLO
WASTE BINS AND SINK BASE UNITS

Tipologie

- 1 Base lavello con estrattore.
1A - Kit sottovasca porta oggetti, per base l 750, 900, 1050, 1200.
1B - Pattumiera T3 per raccolta differenziata h 266, con vani porta spugne. Per base l 600, 750, 900, 1050, 1200.
- 2 Base lavello con estrattore unico l 600 e pattumiera P-One inclusa.
2A - P-One 4 secchi, h 360.
- 3 Base con estrattore unico l 450, 600 e pattumiera P-One inclusa.
3A - P-One h 550. 1 o 2 secchi per base l 450; 1, 2 o 3 secchi per base l 600.
- 4 Base lavello con anta battente.
4A - Pattumiera estraibile h 350, per base l 450, 600, 900, 1200, utilizzabile solo nelle basi lavello h 840.
4B - Pattumiera Base System per raccolta differenziata, h 360. Per base l 600, 900, 1200.
4C - Pattumiera Box ad estrazione totale, h 380, per base l 450, 600, 900, 1200. Box 1 e Box 2, l 275; Box 3, l 390.

Types

- 1 Sink base unit with pull-out storage basket.
1A - Under-basin kit for objects, for base unit w 29 1/2", 35 1/2", 41 1/4", 47 1/4".
1B - Waste bin T3 for separate waste h 10 1/2", with compartments for sponges. For base unit w 23 1/2", 29 1/2", 35 1/2", 41 1/4"; 47 1/4".
- 2 Sink base unit with single pull-out storage basket w 23 1/2" and P-One waste bin included. 2A - P-One 4 buckets, h 14 1/4".
- 3 Base unit with single pull-out storage basket w 17 3/4", 23 1/2" and P-One waste bin included. 3A - P-One h 21 3/4". 1 or 2 buckets for base unit w 17 3/4"; 1, 2 or 3 buckets for base unit w 23 1/2".
- 4 Sink base unit with leaf door.
4A - Pull-out waste bin h 13 3/4", for base unit w 17 3/4", 23 1/2", 35 1/2", 47 1/4", to be used only in sink base units h 33".
4B - Base System waste bin for separate waste, h 14 1/4". For base unit w 23 1/2", 35 1/2", 47 1/4". 4C - Box waste bin with full extraction glides, h 15", for base unit w 17 3/4", 23 1/2", 35 1/2", 47 1/4". Box 1 and Box 2, w 10 3/4"; Box 3, w 15 1/4".

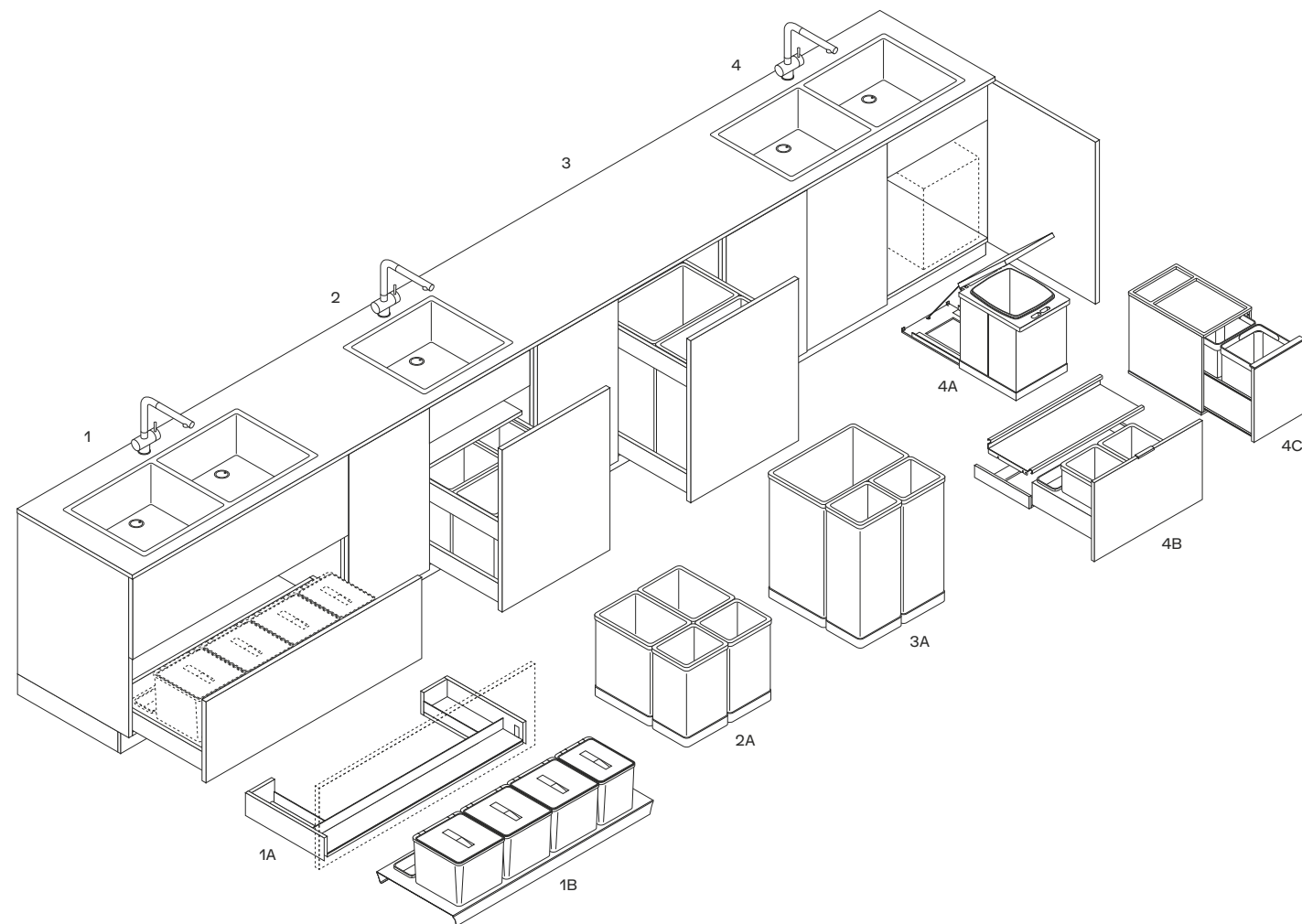

SOLUZIONI DI ILLUMINAZIONE
LIGHTING SOLUTIONS

Illuminazione sul piano di lavoro

- 1 Profilo luminoso multiled.
- 2 Canalina multiled per pannello sottopensile.
- 3 Barra retro pensile.
- 4 Barra sotto pensile.
- 5 Faretto Dual Color.

Lighting on worktop

- 1 Multiled lighted profile.
- 2 Multiled channel for panel under the wall unit.
- 3 Bar on the back of the wall unit.
- 4 Bar under wall unit.
- 5 Dual Color led spotlight.

Luci interne

- 6 Cassetti.
- 7 Estrattori.
- 8 Ante battenti.
- 9 Pensili.
- 10 Colonne.

Inner lights

- 6 Drawers.
- 7 Pull-out baskets.
- 8 Leaf doors.
- 9 Wall units.
- 10 Tall units.

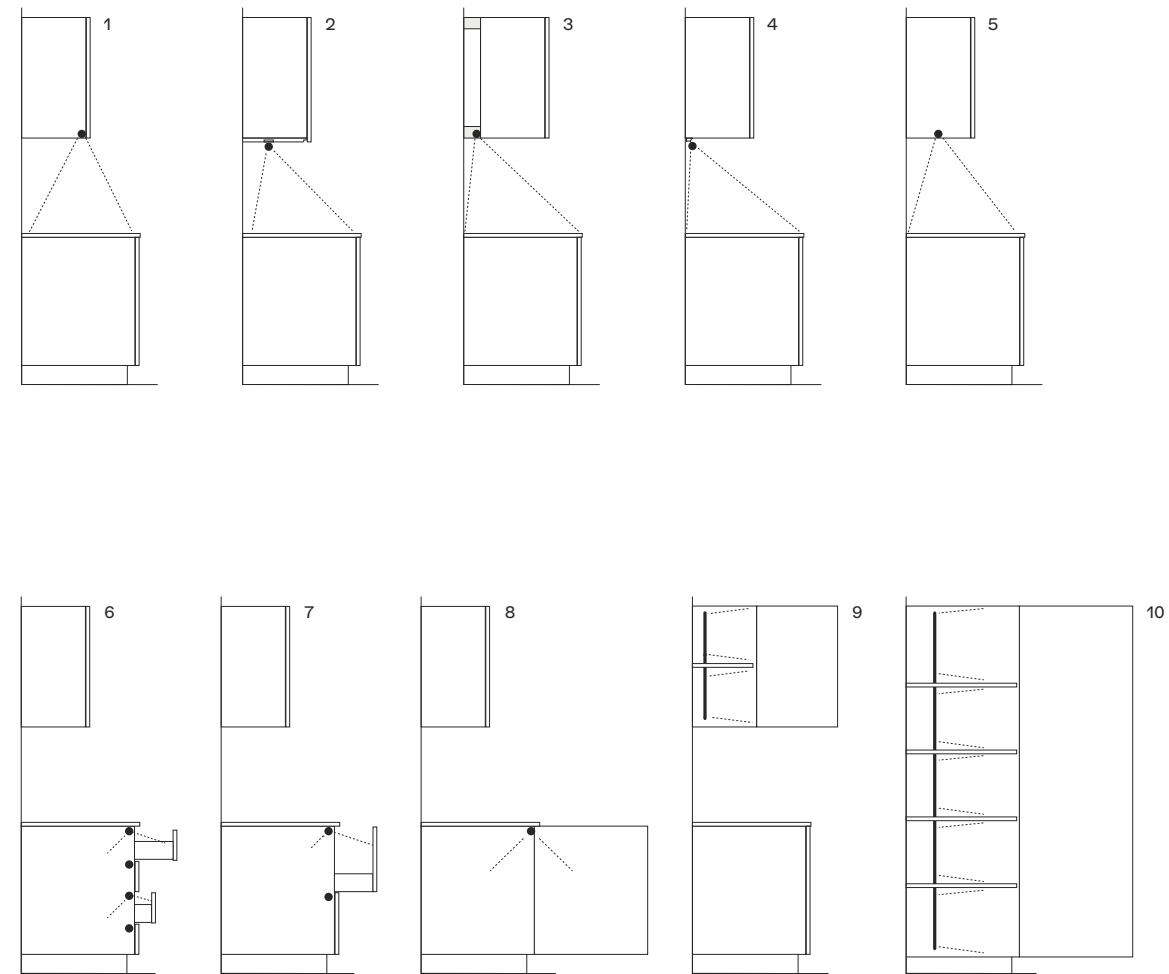

PIANI SNACK SNACK TABLES

Modelli e caratteristiche

- 1 Blade, piano spessore 40.
Da utilizzare sospeso o con gambe.
Piano e gambe in massello di noce canaletto, black ash o tinto olmo nero.
La lunghezza dello snack rettangolare si può personalizzare al centimetro.
Rettangolare da l 1400 a l 2700, p 900-950-1050-1150-1200-1280. Quadrato 1500 x 1500.
- 2 Snack per piani con telaio di supporto, piano spessore 52.
Da utilizzare su piani sp. 6-12-20 con telaio di supporto alluminio previsti per modelli Artex, Twelve, Phoenix e Shape.
Piano in rovere gold, rovere spessart, rovere tinto grigio, olmo, olmo nero o noce c.; massello di noce canaletto, black ash o tinto olmo nero; laminato tuttocolore, laminato tuttocolore touch, laccato goffrato colori, laccato opaco colori o in DuPont Corian®.
L fino a 3000 snack laccati o legno, l fino a 3600 snack in DuPont Corian®, l fino a 4100 snack in laminato.
- 3 Sydney, piano spessore 40.
Da utilizzare sospeso o con gamba.
Piano e gamba in massello di noce canaletto, black ash o tinto olmo nero.
Sydney l 1550-1700-1850-2150 x 788, l 2450 x 895.
Sydney con gamba l 1850 x 925, l 2150 x 1025.
- 4 Moon, piano spessore 40.
Piano, gambe e inserto finta gamba in massello di rovere fossile, black ash o tinto olmo nero.
Piano centrale girevole in marmo lucido e levigato, pietra e quarziti naturali. Ø 1500 con due gambe.
Ø 1800 con tre gambe e piano centrale girevole integrato.
- 5 Lama, piano spessore 37.
Da utilizzare su piani sp. 6-12-20-30 40-52.
Piano in in rovere gold, rovere spessart, rovere tinto grigio, olmo, olmo nero o noce c., laccato goffrato colori, marmo lucido e levigato, pietra, Inalco MDi®, quarzite lucida e micropallinata o Dekton.

Gamba e supporto piano rastremato in laccato goffrato colori, laccato opaco champagne, piombo, ottone, bronzo, alluminio e laccato STM champagne. Ø 1200 - 1400.

- 6 Planar, piano snack in continuità con i piani delle basi Alea Pro.
Piano sostenuto da telaio Planar con gola Alea Pro, fianco di finitura a terra con spallone interno Ala.
Piano in laminato tuttocolore, laminato tuttocolore touch, DuPont Corian®, acciaio scotch brite, marmo lucido e levigato, pietra e quarziti naturali, Inalco MDi® o Dekton.
Telaio Planar p 360 per composizioni con uno o due spalloni Ala l 358.
Telaio Planar a isola: p 950-1050-1180, spallone Ala l 990-1090-1220.

Models and features

- 1 Blade, top thickness 1 1/2".
Suspended or with legs.
Top and legs in solid walnut canaletto, black ash or stained black elm.
The length of the rectangular snack top can be customized to the centimeter.
Rectangular from w 55" to w 106 1/4", d 35 1/2"-37 1/2"-41 1/4"-45 1/4" 47 1/4"-50 1/2". Square 59" x 59".
- 2 Snack tops for worktops with support frame, top thickness 2".
To be used on worktops thickness 1/4"-1/2"-3/4" with aluminium support frame foreseen for models Artex, Twelve, Phoenix and Shape.
Top in gold oak, spessart oak, stained grey oak, elm, black elm or walnut c.; solid walnut canaletto, black ash or stained black elm; laminate tuttocolore, laminate tuttocolore touch, embossed lacquered colours, mat lacquered colours or in DuPont Corian®.
W up to 118" snack tops in lacquer or wood, w up to 141 3/4" snack tops in DuPont Corian®, w up to 161 1/2" snack tops in laminate.
- 3 Sydney, top thickness 1 1/2".
Suspended or with leg.
Top and leg in solid walnut canaletto, black ash or stained black elm.
Sydney w 61"-67"-72 3/4"-84 3/4" x 31", w 96 1/2" x 35 1/4".
Sydney with leg w 72 3/4" x 36 1/2", 84 3/4" x 40 1/4".
- 4 Moon, top thickness 1 1/2".
Top, legs and insert on the top in solid fossil oak, black ash or stained black elm.
Swivel central top in glossy and mat marble, natural stone and natural quartzite. 59" with two legs.
70 3/4" with three legs and integrated central swivel top.
- 5 Lama, top thickness 1 1/2".
To be used on tops th. 1/4"-1/2"-3/4" 1 1/4"-1 1/2"-2".
Top in gold oak, spessart oak, stained grey oak, elm, black elm or walnut c., embossed lacquered colours, glossy and mat marble, stone, Inalco MDi®, glossy and bead blasted composite stone or Dekton.

Leg and support of the tapered top in embossed lacquered colours, mat lacquered champagne, piombo, ottone, bronzo, alluminio and lacquered STM champagne. Ø 47 1/4" - 55".

- 6 Planar, snack top in continuity with the tops of the base units Alea Pro.
Top supported by Planar frame with Alea Pro channel, floorstanding finishing side with internal thick side Ala.
Top in laminate tuttocolore, laminate tuttocolore touch, DuPont Corian®, scotch brite steel, glossy and mat marble, natural stone and natural quartzite, Inalco MDi® or Dekton.
Planar frame d 14 1/4" for compositions with one or two thick sides Ala w 14".
Planar island frame: d 37 1/2"-41 1/4" 46 1/2", thick side Ala w 39"-43"-48".

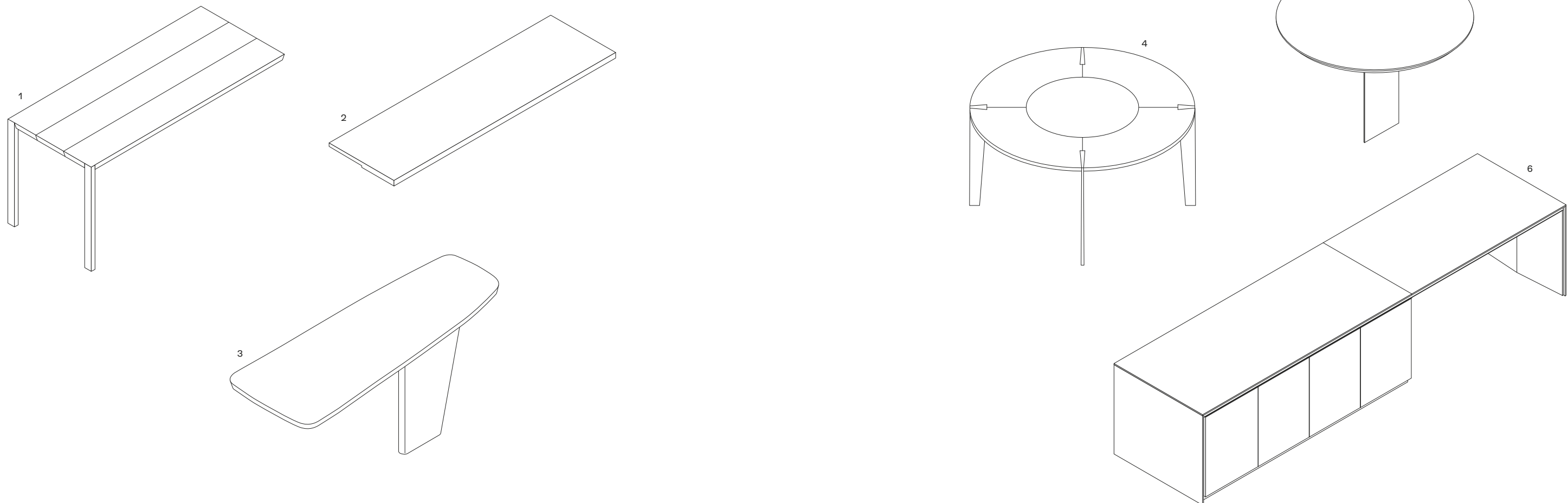

FINITURE ANTA
DOOR FINISHINGS

Laccato gofrato
Embossed lacquer



Laccato opaco
Mat lacquer



Laccato lucido
Glossy lacquer

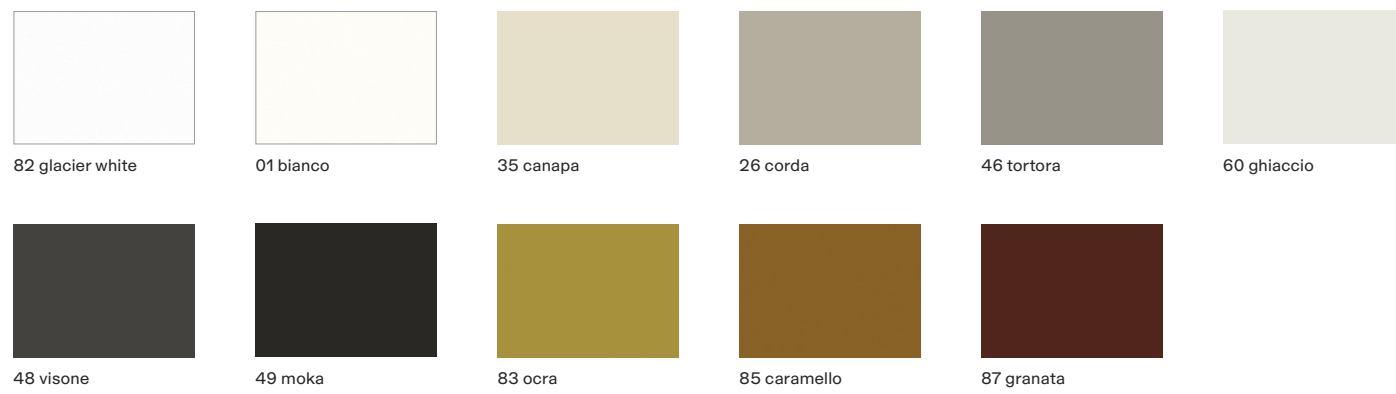

Essenza
Wood



Massello
Solid wood

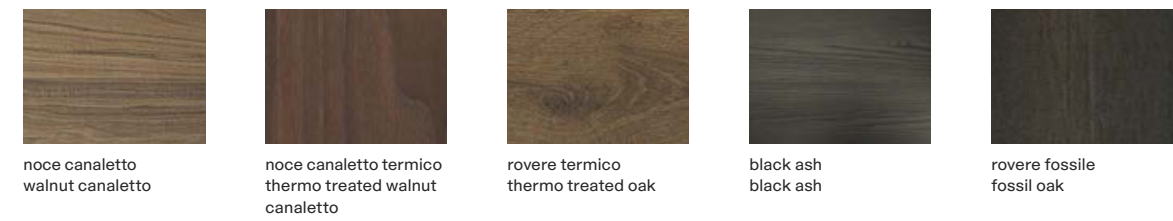

Massello fresato
Milled solid wood

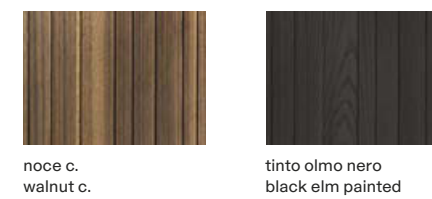

Nobilitato
Melamine



STM
STM



Laccato metallico
Metal lacquer

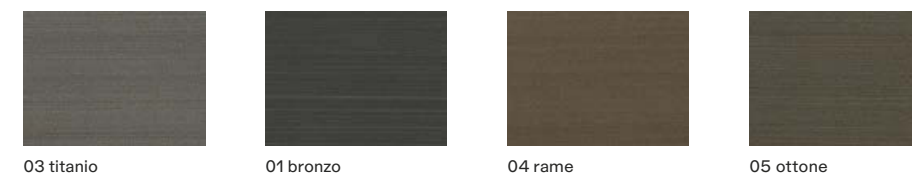

FINITURE ANTA
DOOR FINISHINGS

Inalco MDi®
Inalco MDi®



06 carrara touch



02 calacatta oro touch



05 stone brown

Acciaio
Steel



scotch brite



scotch brite Ronda

Acciaio PVD
PVD steel



nero Ronda



bronzo Ronda

Vetro
Glass

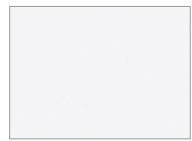

bianco
extrachiaro - extralight
2301 satinato - frosted
2201 lucido - glossy

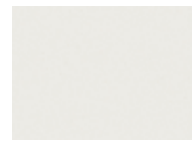

ghiaccio
extrachiaro - extralight
2373 satinato - frosted
2273 lucido - glossy



castoro
extrachiaro - extralight
2388 satinato - frosted
2288 lucido - glossy

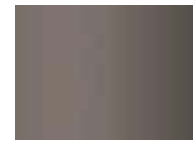

moka
extrachiaro - extralight
2349 satinato - frosted
2249 lucido - glossy



grafite
1304 satinato - frosted
1204 lucido - glossy



nero
1303 satinato - frosted
1203 lucido - glossy

Laminato opaco
Mat laminate



U1 super white

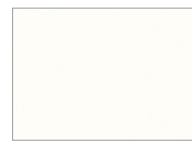

01 bianco

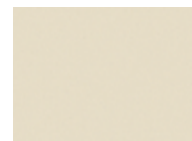

35 canapa

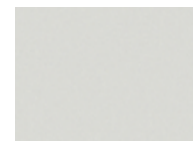

U2 silver gray

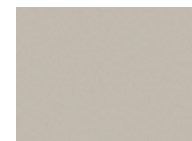

U3 sand



04 grafite

Laminato opaco touch
Mat laminate touch

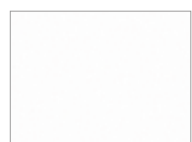

F4 super white touch



F1 bianco touch

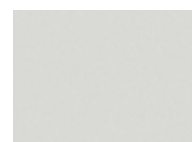

F5 silver gray touch

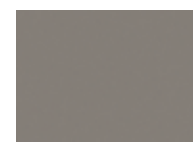

87 grigio Londra



F6 ardesia touch



F3 castoro touch



F2 nero touch

Laminato satinato touch
Satin laminate touch



F7 acciaio



F8 alluminio



F9 champagne

LCT
LCT



F4 super white

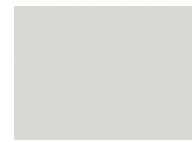

F5 silver gray



F7 sand

Vetrine
Showcases



5051 bronzato-bronzed
vetro riflettente
reflecting glass



5059 fumé
vetro riflettente
reflecting glass



anodizzato champagne
anodized champagne



anodizzato moka
anodized moka



anodizzato nero
anodized nero



verniciato bronzo
bronze painted

Telaio vetrine
Showcases frame

Interno personalizzato vetrine
Personalized showcases interior



rovere gold
gold oak



rovere tinto grigio
stained grey oak



rovere spessart
spessart oak



olmo
elm

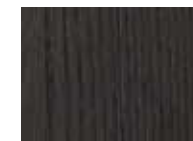

olmo nero
black elm



noce c.
walnut c.



noce canaletto termico
thermo treated walnut
canaletto



noce canaletto naturale
natural walnut canaletto



nobilitato olmo smoke
smoke elm melamine

Struttura
Structure



G2 nobilitato
grigio perla
grey perla melamine

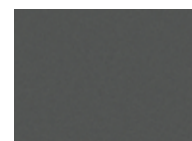

G3 nobilitato
grigio lavagna
grey lavagna melamine

FINITURE PIANO
TOP FINISHINGS

Quarzite lucida
Glossy composite stone



21 super white 28 white veined 22 portland grey 18 brughiera sand 11 raven sand



25 white va 26 beige va 27 storm va

Quarzite micropallinata
Micro-blasted composite stone



21 super white 28 white veined 22 portland grey 18 brughiera sand 11 raven sand 24 dark

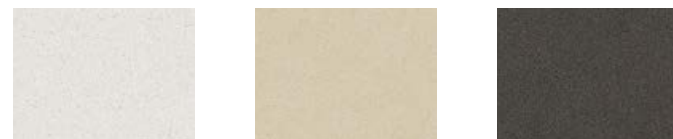

25 white va 26 beige va 27 storm va

Inalco MDi®
Inalco MDi®



07 bianco 06 carrara touch 02 calacatta oro touch 03 statuario touch 05 stone brown 01 roccia fiammata



08 nero

Inalco MDi® induction *
Inalco MDi® induction



09 stone brown

* per piano cottura a induzione sottotop for undermount induction hob

Marmo levigato
Mat marble



bianco carrara calacatta oro emperador extra dark noir saint laurent statuario altissimo

Marmo lucido
Glossy marble



calacatta oro emperador extra dark noir saint laurent statuario altissimo

Pietra
Stone



fossena fiammata / blaze stone brown levigata / mat stone grey levigata / mat stone grey Azerocare * levigata / mat

* Azerocare, trattamento protettivo brevettato
Azerocare, patented protective treatment

Quarzite naturale
Natural quartzite



sky gold opaco / mat breccia imperiale levigata / mat breccia imperiale lucida / glossy

FINITURE PIANO
TOP FINISHINGS

**Dekton
Dekton**



05 bianco 06 neural 02 tortora 01 nero

**DuPont Corian®
DuPont Corian®**

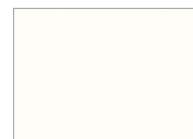

93 glacier white

**Acciaio
Steel**

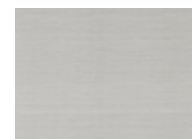

scotch brite Barazza

**Vetro extrachiaro satinato
Frosted extralight glass**



2301 bianco 2373 ghiaccio 2388 castoro 2349 moka 1304 grafite 1303 nero

**Laminato tuttocolore
Tuttocolore laminate**



U1 super white 01 bianco 35 canapa U2 silver gray U3 sand 04 grafite

**Laminato tuttocolore touch
Tuttocolore laminate touch**



F4 super white touch F1 bianco touch F5 silver gray touch 87 grigio Londra touch F6 ardesia touch F3 castoro touch



F7 acciaio touch F8 alluminio touch F9 champagne touch F2 nero touch

**Essenza
Wood**



rovere gold rovere tinto grigio rovere spessart olmo olmo nero noce c.

Sui top in essenza non è possibile prevedere incassi per piani cottura e lavelli.

Worktops in wood are not available with cut outs for built-in hobs and sinks.

Poliform Spa
via Montesanto 28
Casella postale n. 1
22044 Inverigo (CO) Italy
t +39 031 6951
f +39 031 699444
info@poliform.it
poliform.it



2018 Adi Compasso D'oro
Career Award

Poliform realizza tutte le sue collezioni in Italia usando componenti e materie prime selezionate.

All the Poliform collections are manufactured 100% in Italy using top-class components and materials.

Poliform si riserva il diritto di apportare, senza preavviso, ogni modifica mirata al miglioramento funzionale e qualitativo dei propri prodotti. Testi e disegni presenti in questo stampato hanno scopo divulgativo: per ogni aspetto tecnico e dimensionale fare riferimento ai listini aziendali e relativi aggiornamenti. I campioni di colori e materiali hanno valore indicativo.

Poliform reserves the rights at all time to apply modifications for the functional or qualitative improvement of its products. Texts and drawings present in this brochure have a divulgative purpose: for every technical and dimensional aspect please refer to the company's price lists and their relative updatings. The colour and material samples have an indicative value.

Creative Direction
Apartamento Studios

Graphic Design
Apartamento Studios

Interiors Photography
Federico Cedrone, F2 Fotografia, Omar Sartor

Still Life Photography
Silvia Orlandi

Interiors Styling
Poliform Lab

1st edition November 2022
cod. K55/R1/2022



POLIFORM.COM