

DAY COMPLEMENTS  
2022

Poliform





**Poliform**

Poliform presenta la collezione di complementi. Sedie, panche, sgabelli, tavoli, madie e scrittoi pensati per completare con eleganza la zona giorno – ma anche la zona notte, oggi che l'abitare ha assunto forme sempre più fluide. Sedute dove design e comfort si uniscono in un equilibrio perfetto, tavoli caratterizzati da forme essenziali e finiture di pregio, madie dall'estetica rigorosa ma attuale, scrittoi capaci di interpretare lo spazio in base alle esigenze. In filigrana, come sempre, lo stile di Poliform, eccellente nella qualità del design, nell'armonia delle forme e nella selezione dei materiali.

Poliform presents the collection of complements. Chairs, benches, stools, tables, sideboards, and writing desks designed to elegantly complete the day area – but also the night area, now that living has taken on increasingly fluid forms. Seats where design and comfort combine in perfect balance, tables characterized by minimalistic shapes and fine finishes, sideboards of a rigorous yet modern style, writing desks capable of interpreting the space according to needs. At the base of everything, as always, Poliform's style, excellent in the quality of design, in the harmony of shapes, and in the selection of materials.

COLLECTIONS

SEDIE CHAIRS	7
PANCHE BENCHES	117
SGABELLI STOOLS	141
TAVOLI TABLES	183
SCRITTOI E CONSOLLE DESKS AND CONSOLE	319
MADIE E LIBRERIE SIDEBOARDS AND BOOKCASES	351

# CHAIRS

Rigore delle forme, essenzialità delle linee, eleganza impeccabile di finiture e rivestimenti: questo è lo stile delle sedie Poliform. Dalle poltroncine alle sedie, dal design più classico al più provocatorio, la collezione si compone di proposte che sanno unire estetica e comfort, ideali attorno a un tavolo da pranzo così come accanto a uno scrittoio. Sempre particolari le lavorazioni delle basi e dei rivestimenti sartoriali in tessuto o pelle. I progetti sono firmati da Jean-Marie Massaud, Rodrigo Torres, Emmanuel Gallina, Rodolfo Dordoni.

Rigour of shapes, minimalism of lines, impeccable elegance of finishes and upholstery: this is the style of the Poliform chairs. From the armchairs to the chairs, from the most classic to the most provocative design, the collection consists of offers that know how to combine style and comfort, ideal around a dining table as well as next to a desk. Always particular are the details of the bases and of the tailored upholstery in fabric or leather. The projects are signed by Jean-Marie Massaud, Rodrigo Torres, Emmanuel Gallina, Rodolfo Dordoni.

## CHAIRS

SOPHIE LITE	11
SOPHIE	23
STANFORD BRIDGE	35
GRACE	47
VENTURA	61
SEATTLE	75
IPANEMA	87
MANTA	99
GUEST	109



# SOPHIE LITE



La sedia Sophie Lite è l'evoluzione contemporanea e leggera dello storico modello Sophie. Resta la struttura in legno massello, mentre la seduta si distingue per lo schienale sagomato, rivestito in tessuto o pelle. Accogliente ed elegante, Sophie Lite rappresenta il nuovo, perfetto completamento di tutti i tavoli della collezione Day Complements.

The Sophie Lite chair is the contemporary and lightweight evolution of the historical Sophie model. The solid wood structure is unchanged, while the seat features a shaped backrest, upholstered in fabric or leather. Inviting and elegant, Sophie Lite is the new, perfect complement to all the tables in the Day Complements collection.









Nelle pagine precedenti: sedie Sophie Lite con braccioli, rivestimento sfoderabile in tessuto Antea 03 visone e struttura in olmo nero. Tavolo Henry in olmo nero con piano in marmo sahara noir levigato finitura poliestere. Madio Symphony in rovere gold con top in marmo levigato sahara noir finitura poliestere, maniglia e basamento con piedini in brown nickel opaco. Tappeto Cannelé. In questa pagina: sedia Sophie Lite con bracciolo, rivestimento sfoderabile in pelle Silk 02 beige e struttura in rovere spessart.

Previous pages: Sophie Lite chairs with armrests, removable cover in fabric Antea 03 visone and structure in black elm. Henry table in black elm with top in mat marble sahara noir with polyester finish. Symphony sideboards in gold oak with top in mat marble sahara noir polyester finish, handle and base with feet in mat brown nickel. Carpet Cannelé. This page: Sophie Lite chair with armrest, removable cover in leather Silk 02 beige and structure in spessart oak.





In questa pagina: sedia Sophie Lite senza bracciolo, rivestimento sfoderabile in tessuto Arcadia 05 bronzo e struttura in noce gold. Nella pagina successiva: sedie Sophie Lite con braccioli, rivestimento sfoderabile in tessuto Antea 03 visone e struttura in olmo nero. Tavolo Henry con piano in marmo levigato sahara noir finitura poliestere e struttura in olmo nero. Tappeto Cannelé.

This page: Sophie Lite chair without armrests, cover in removable fabric Arcadia 05 bronzo and gold walnut structure. Next page: Sophie Lite chairs with armrests, removable cover in fabric Antea 03 visone and structure in black elm. Henry table with top in mat marble sahara noir polyester finish and structure in black elm. Carpet Cannelé.

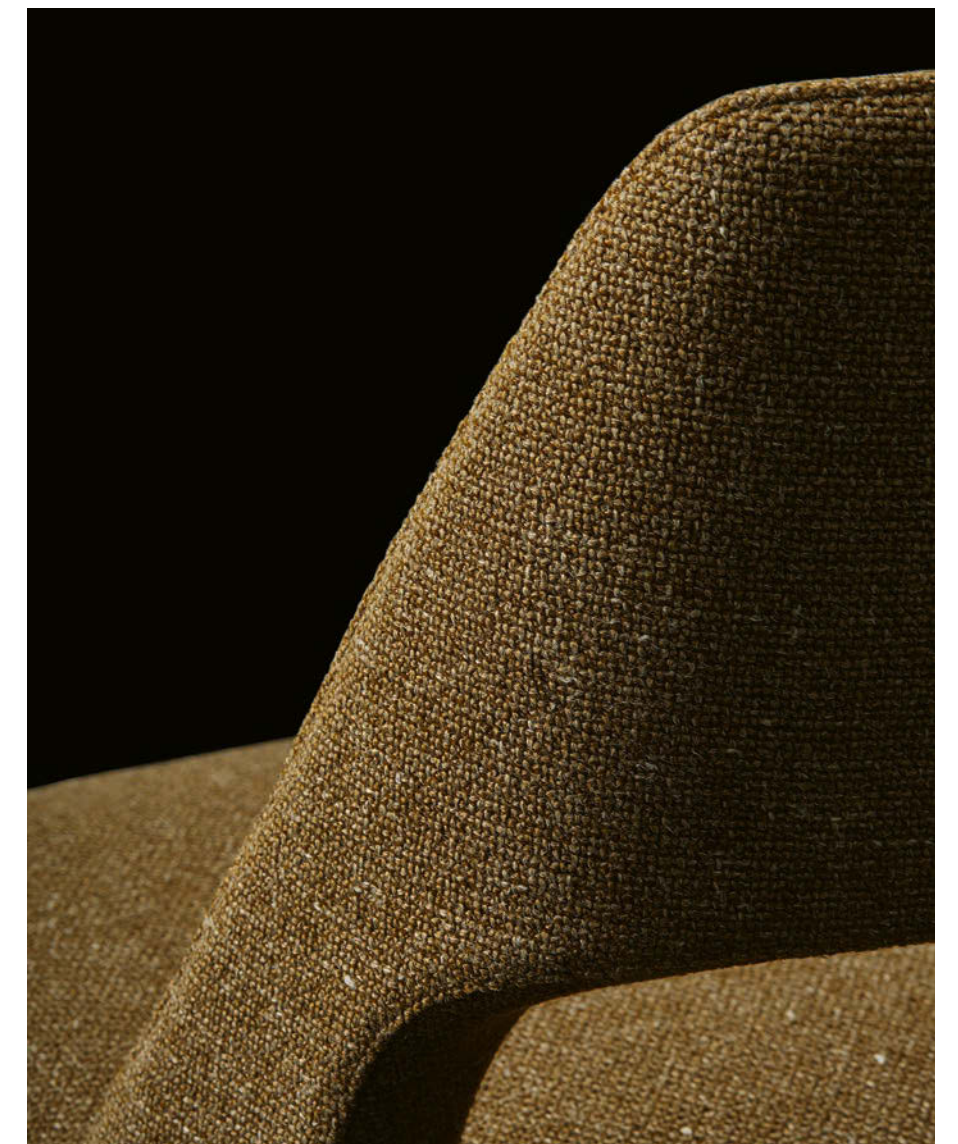





## SOPHIE LITE

Design Emmanuel Gallina, 2020

Seduta e schienale con parti in poliuretano flessibile a quote differenziate e parti in poliuretano flessibile stampato, priverivestimento in fibra di poliestere. Rivestimento sfoderabile in tessuto o pelle. Struttura in massello, finitura in noce gold, rovere spessart o olmo nero.

Seat and backrest with parts in flexible polyurethane in different densities and parts in flexible moulded polyurethane, pre-cover in polyester fibre. Removable cover in fabric or leather. Structure in solid wood in the finishes gold walnut, spessart oak or black elm.

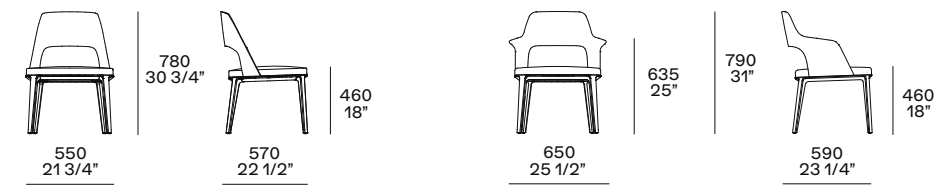



# SOPHIE





Emmanuel Gallina disegna una sedia dalle linee avvolgenti e dalle proporzioni generose, reinterpretando in chiave contemporanea una forma classica. Sophie è caratterizzata dalla seduta solida, cui fa da contrappunto una struttura leggera in legno massello. Disponibile nelle due versioni con o senza braccioli, si può rivestire in tessuto o pelle.

Emmanuel Gallina designs a chair with enveloping lines and generous proportions, reinterpreting a classic shape with a contemporary eye. Sophie is characterized by a solid seat, which contrasts a light solid wood structure. Available in two versions with or without armrests, fabric or leather.









Nelle pagine precedenti: sedie Sophie con braccioli, rivestimento non sfoderabile in tessuto Kitami 04 sabbia, struttura in olmo nero. Tavolo Henry in olmo nero con piano in marmo sahara noir levigato finitura poliester. Madia Code in olmo nero con top in marmo zecevo levigato e basamento con piedini ardesia opaco. Ante in vetro trasparente riflettente, struttura interna in olmo nero con schienale in tessuto lino chiaro. Tappeto Tratto ruggine. In questa pagina: sedia Sophie con braccioli, rivestimento non sfoderabile in pelle Soft 10 prugna, struttura in olmo nero.

Previous pages: Sophie chairs with armrests, non-removable cover in fabric Kitami 04 sabbia, black elm structure. Henry table in black elm with top in mat marble sahara noir with polyester finish. Code sideboard in black elm with top in mat marble zecevo and base with feet in mat ardesia. Doors in transparent reflecting glass, inner structure in black elm with back in fabric lino chiaro. Carpet Tratto ruggine. This page: Sophie chair with armrests, non-removable cover in leather Soft 10 prugna, black elm structure.





In questa pagina: sedia Sophie senza braccioli, rivestimento non sfoderabile in tessuto Antea 03 visone, struttura in noce gold. Nella pagina successiva: sedie Sophie con e senza braccioli, rivestimento non sfoderabile in pelle Soft 14 oliva, struttura in olmo nero. Tavolo Concorde con struttura e cornice piano in olmo nero, piano in vetro lucido bordeaux.

This page: Sophie chair without armrests, non-removable cover in fabric Antea 03 visone, gold walnut structure. Next page: Sophie chairs with and without armrests, non-removable cover in leather Soft 14 oliva, black elm structure. Concorde table with structure and tabletop frame in black elm, top in glossy glass bordeaux.







## SOPHIE

Design Emmanuel Gallina, 2017

Seduta e schienale con parti in poliuretano flessibile a quote differenziate e parti in poliuretano flessibile stampato, priverivestimento in fibra di poliestere. Rivestimento non sfoderabile in tessuto o pelle. Struttura in massello, finitura in noce gold, rovere spessart o olmo nero.

Seat and backrest with parts in flexible polyurethane in different densities and parts in flexible moulded polyurethane, pre-cover in polyester fibre. Non-removable cover in fabric or leather. Structure in solid wood in the finishes gold walnut, spessart oak or black elm.

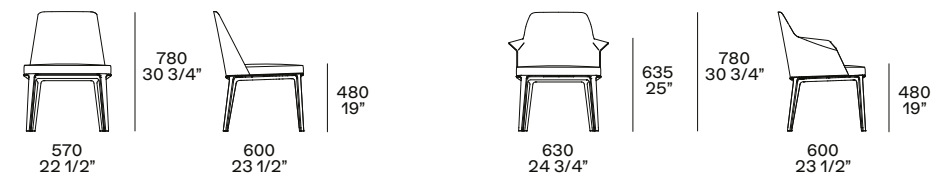

# STANFORD BRIDGE



Un guscio sottile e avvolgente come un abito appoggia su un'esile struttura con base girevole. Stanford Bridge è la naturale evoluzione della poltrona Stanford: una sedia, con o senza braccioli, dall'eleganza discreta e contemporanea. Rivestita in tessuto o pelle, è pensata per gli spazi di casa ma è ideale anche negli ambienti di lavoro.

A thin shell enveloping like a dress rests on a slender structure with a revolving base. Stanford Bridge is the natural evolution of the Stanford armchair: a chair, with or without armrests, of a discreet and contemporary elegance. In fabric or leather, it is designed for home spaces but it is also ideal for work environments.









Nelle pagine precedenti: sedie Stanford Bridge con braccioli, rivestimento sfoderabile in tessuto Kitami 04 sabbia, basamento girevole in brown nickel lucido. Tavolo Kensington struttura in spatolato bronzo e piano in olmo nero. Madia Home Hotel in olmo nero, ante e cassetti con frontali sagomati laccato opaco caramello e bordo in olmo nero. Pouf New York rivestimento sfoderabile in tessuto Agadir 01 sabbia e piedini brown nickel opaco. In questa pagina: sedia Stanford Bridge con braccioli, rivestimento sfoderabile in tessuto Nancy 100 cenere, basamento girevole in champagne opaco.

Previous pages: Stanford Bridge chairs with armrests, removable cover in fabric Kitami 04 sabbia, swivel base in glossy brown nickel. Kensington table with structure in bronzo with spatula effect and top in black elm. Home Hotel sideboard in black elm, doors and drawers with caramello mat lacquered shaped fronts and edge in black elm. New York pouf with removable cover in fabric Agadir 01 sabbia and mat brown nickel feet. This page: Stanford Bridge chair with armrests, removable cover in fabric Nancy 100 cenere, swivel base in mat champagne.





In questa pagina: sedia Stanford Bridge senza braccioli, rivestimento sfoderabile in pelle Soft 14 oliva, basamento girevole in brown nickel lucido. Nella pagina successiva: sedia Stanford Bridge senza braccioli, rivestimento sfoderabile in pelle Soft 03 nocciola, basamento girevole in brown nickel opaco. Tavolo Flute laccato opaco carbone con piano in marmo lucido sahara noir finitura poliester. Pouf Onda in velluto non sfoderabile Persia 1401 oliva. Tappeto Plain tortora.

This page: Stanford Bridge chair without armrests, removable cover in leather Soft 14 oliva, swivel base in glossy brown nickel. Next page: Stanford Bridge chair without armrests, removable cover in leather Soft 03 nocciola, swivel base in mat brown nickel. Carbone mat lacquered Flute table with top in glossy marble sahara noir with polyester finish. Onda pouf in non-removable velvet Persia 1401 oliva. Carpet Plain tortora.

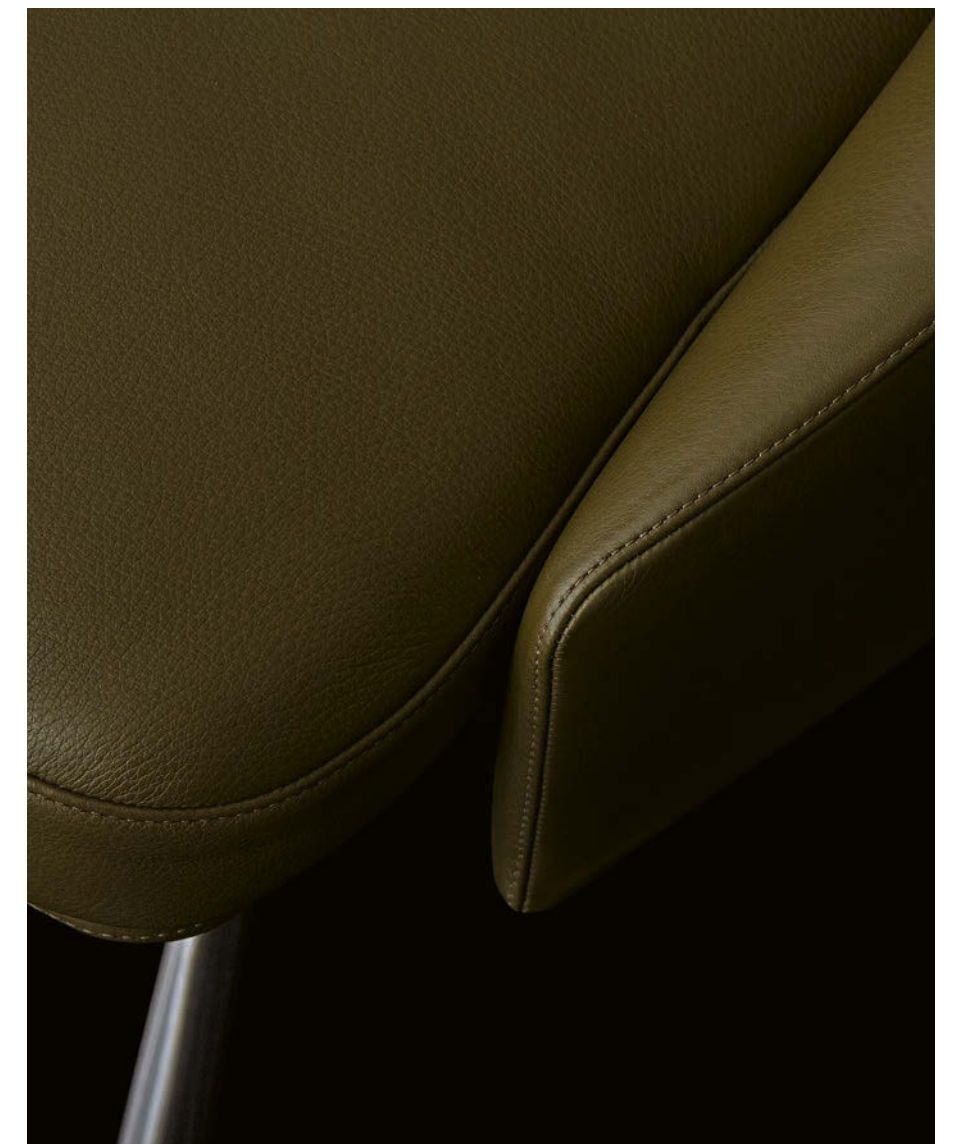





## STANFORD BRIDGE

Design Jean-Marie Massaud, 2018

Scocca in poliuretano flessibile stampato, sedile in poliuretano flessibile a quote differenziate, prerivestimento in fibra di poliestere. Rivestimento in tessuto sfoderabile o pelle non sfoderabile.

Basamento girevole con ritorno, fusione di alluminio verniciato champagne opaco o brown nickel opaco e lucido.

Body in flexible moulded polyurethane, seat in flexible polyurethane in different densities, pre-cover in polyester fibre. Cover in removable fabric or non-removable leather. Base with automatic returning mechanism, mat champagne or mat and glossy brown nickel painted aluminium casting.

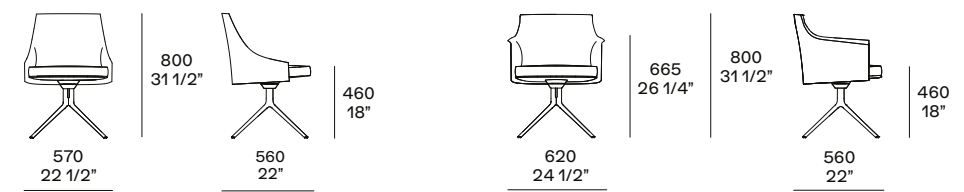



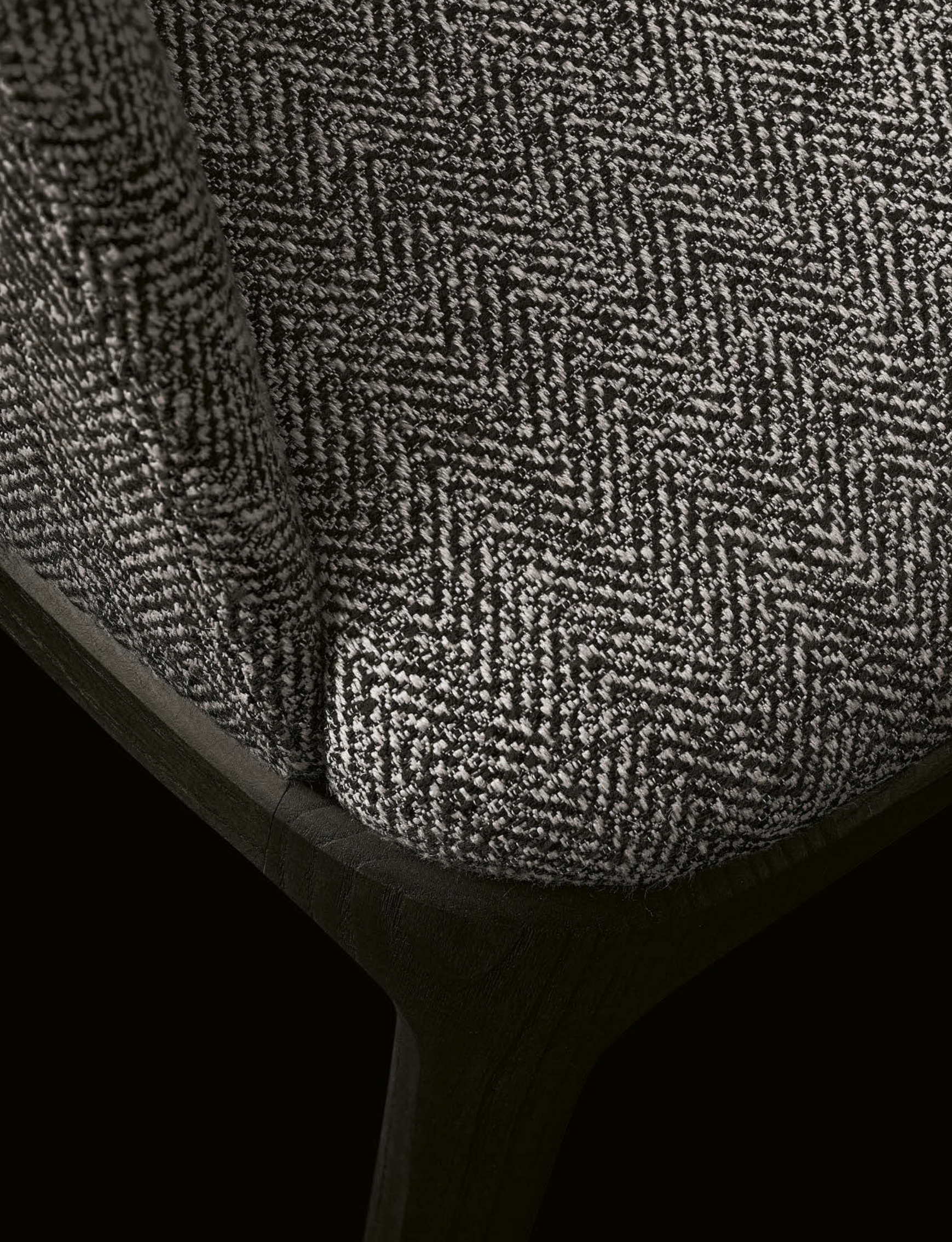

# GRACE



Vero classico contemporaneo, con la sua struttura slanciata e la seduta accogliente Grace è allo stesso tempo elemento estetico e risposta funzionale alle esigenze dell'abitare. La sedia è disponibile con o senza braccioli e rivestita in tessuto o pelle, anche con schienale in pelle intrecciata.

A true contemporary classic, with its slender structure and welcoming seat, Grace is at the same time an aesthetic element and a functional answer to the needs of living. The chair is available with or without armrests and upholstered in fabric or leather, also with woven leather backrest.









Nelle pagine precedenti: sedie Grace con braccioli, rivestimento non sfoderabile in pelle Nabuk 05 grafite, struttura in rovere spessart. Tavolo Concorde in rovere spessart con piano in marmo calcatta oro levigato e vassoio centrale girevole in rovere spessart. Pouf Onda in velluto non sfoderabile Persia 1401 oliva. In questa pagina: sedia Grace con braccioli, rivestimento non sfoderabile in tessuto Skyros 07 grafite, struttura in olmo nero.

Previous pages: Grace chairs with armrests, cover in non-removable leather Nabuk 05 grafite, spessart oak structure. Concorde table in spessart oak with top in mat marble calcatta oro, swivel tray in spessart oak. Onda pouf in non-removable velvet Persia 1401 oliva. This page: Grace chair with armrests, cover in non-removable fabric Skyros 07 grafite, black elm structure.





In questa pagina: sedia Grace con braccioli, rivestimento non sfoderabile in pelle Soft 02 mastice, struttura in olmo nero.

This page: Grace chair with armrests, cover in non-removable leather Soft 02 mastice, black elm structure.





In questa pagina: sedia Grace senza braccioli, rivestimento non sfoderabile in pelle Nabuk 01 latte e retro schienale in pelle Nabuk intrecciata 01 latte, struttura in olmo nero. Nella pagina successiva: sedie Grace con e senza braccioli, rivestimento non sfoderabile in pelle Special 48 nocciola, struttura in noce gold. Tavolo Concorde in noce gold con piano in marmo calacatta oro levigato.

This page: Grace chair without armrests, cover in non-removable leather Nabuk 01 latte and rear of the chair backrest in woven leather Nabuk 01 latte, black elm structure. Next page: Grace chair with and without armrests, non-removable cover in leather Special 48 nocciola, gold walnut structure. Concorde table in gold walnut with top in mat marble calacatta oro.





## GRACE

Design Emmanuel Gallina, 2009

Seduta e schienale in poliuretano flessibile stampato a quote differenziate, priverivestimento in fibra di poliestere. Rivestimento non sfoderabile in tessuto, pelle o pelle intrecciata (solo per retro schienale). Struttura in massello, finitura in noce gold, rovere spessart o olmo nero.

Seat and backrest in flexible moulded polyurethane in different densities, pre-cover in polyester fibre. Non-removable cover in fabric, leather or woven leather (available only for the rear of the backrest). Solid wood structure in the finishes gold walnut, spessart oak or black elm.

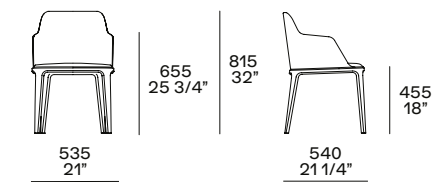
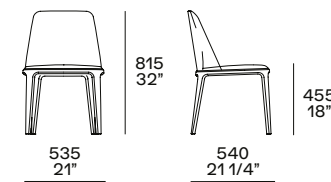





# VENTURA



La sedia Ventura è caratterizzata dalla particolarissima giunzione tra lo schienale e i braccioli, un dettaglio di grande raffinatezza che regala carattere e sensualità. In perfetto equilibrio tra comfort e stile, Ventura è disponibile con struttura in essenza e, per la versione con struttura in metallo, in tutti i colori laccati opachi, da abbinare al rivestimento in tessuto o pelle.

The Ventura chair is characterized by the very particular junction between the backrest and the armrests, a detail of great refinement that gives character and sensuality. In perfect balance between comfort and style, Ventura is available with structure in wood and, for the version with the metal structure, in all the mat lacquered colours, to be combined with the upholstery in fabric or leather.









Nelle pagine precedenti: sedie Ventura con e senza braccioli, rivestimento non sfoderabile in tessuto Caleo 04 tortora, struttura in rovere spessart. Tavolo Howard in rovere spessart con piano in marmo calacatta oro levigato. Pouf Onda in velluto non sfoderabile Persia 1403 ocra. In questa pagina: sedia Ventura senza braccioli, rivestimento non sfoderabile in pelle Nabuk 09 ruggine, cucitura normale doppia, struttura in olmo nero. Nella successiva: sedia Ventura con braccioli, rivestimento non sfoderabile in tessuto Rabat 402 pernice, cucitura a cordoncino in tinta, struttura in olmo nero.

Previous pages: Ventura chairs with and without armrests, non-removable cover in fabric Caleo 04 tortora, structure in spessart oak. Howard table in spessart oak with top in mat marble calacatta oro. Onda pouf in non-removable velvet Persia 1403 ocra. This page: Ventura chair without armrests, non-removable cover in leather Nabuk 09 ruggine, double normal stitching, black elm structure. Next page: Ventura chair with armrests, non-removable cover in fabric Rabat 402 pernice, drawstring stitching in matching colour, black elm structure.

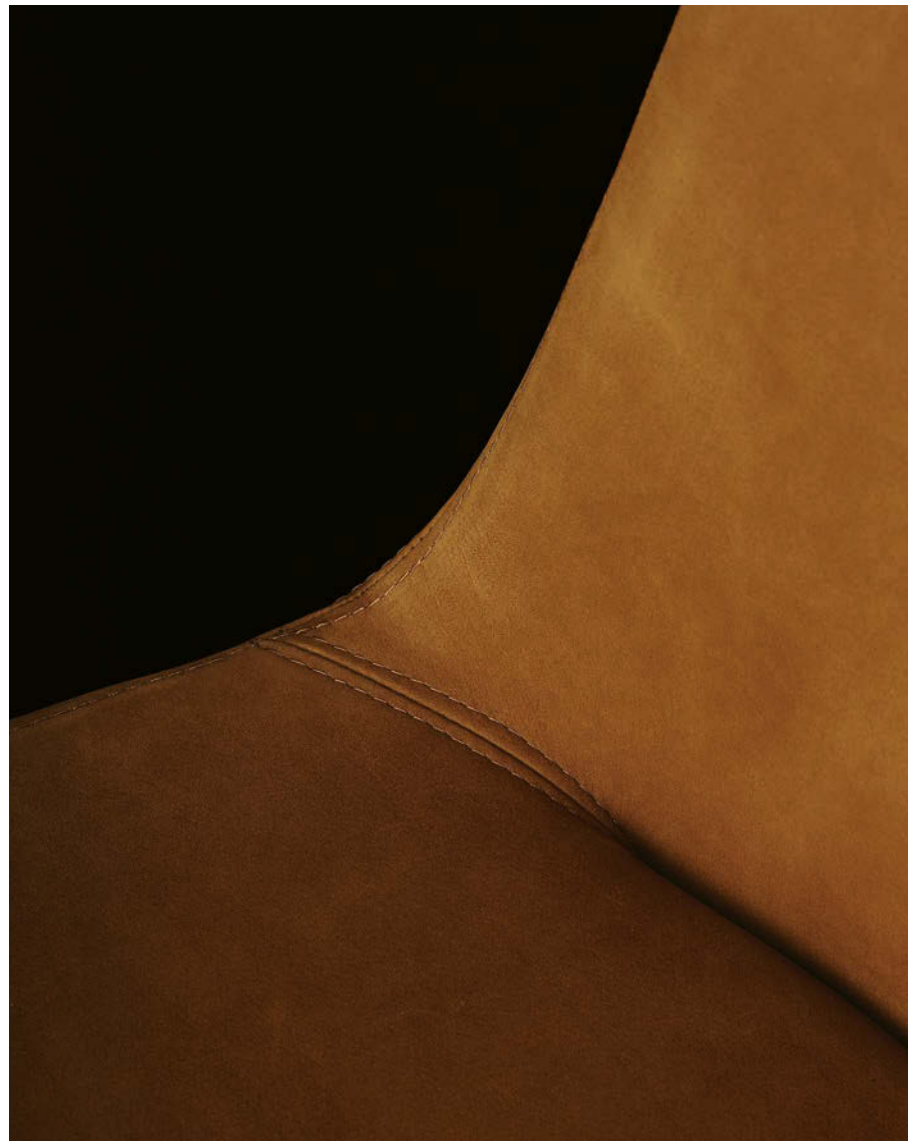



## VENTURA

Design Jean-Marie Massaud, 2011

Scocca in poliuretano flessibile stampato, prriverestimento in fibra di poliestere. Rivestimento non sfoderabile in tessuto o pelle. Cucitura normale doppia o, solo per la versione in tessuto (escluso velluto), cucitura a cordoncino in tinta. Struttura in massello, finitura in rovere spessart o olmo nero.

Body in flexible moulded polyurethane, pre-cover in polyester fibre. Non-removable cover in fabric or leather. Double normal stitching or drawstring stitching in matching colour, only for the version in fabric (except velvet). Structure in solid wood in the finishes spessart oak or black elm.

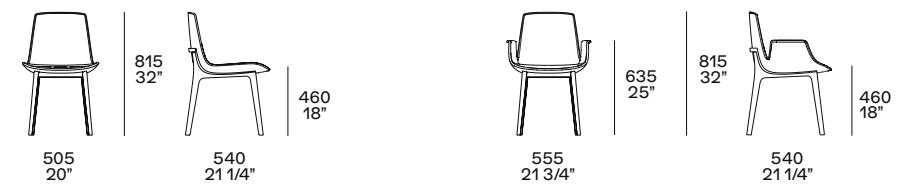



In questa pagina: sedia Ventura con braccioli, rivestimento non sfoderabile in pelle Spring 5402 ghiaccio, cucitura normale doppia, struttura in brown nickel opaco. Nella successiva: sedia Ventura senza braccioli, rivestimento non sfoderabile in tessuto Kitami 09 senape, cucitura a cordoncino in tinta, struttura laccato opaco ocra.

This page: Ventura chair with armrests, non-removable cover in leather Spring 5402 ghiaccio, double normal stitching, structure in mat brown nickel. Next page: Ventura chair without armrests, non-removable cover in fabric Kitami 09 senape, drawstring stitching in matching colour, ocra mat lacquered structure.







## VENTURA

Design Jean-Marie Massaud, 2011

Scocca in poliuretano flessibile stampato, priverivestimento in fibra di poliestere. Rivestimento non sfoderabile in tessuto o pelle. Cucitura normale doppia o, solo per la versione in tessuto (escluso velluto), cucitura a cordoncino in tinta. Struttura in metallo verniciato brown nickel opaco o laccato opaco colori.

Body in flexible moulded polyurethane, pre-cover in polyester fibre. Non-removable cover in fabric or leather. Double normal stitching or, only for the version in fabric (except velvet), drawstring stitching in matching colour. Structure in metal painted mat brown nickel or mat lacquered colours.

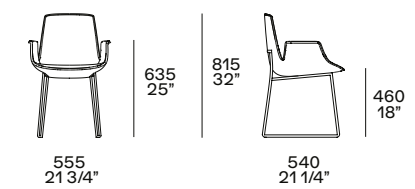
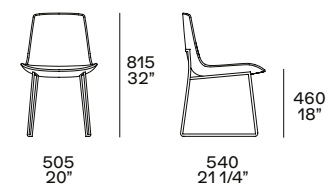



# SEATTLE



Seattle è una sedia che si contraddistingue per l'attenta lavorazione artigianale del rivestimento in cuoio. Le cuciture e la punzonatura sono dettagli d'alta sartoria, messi ulteriormente in evidenza dalla forma leggera e quasi aerea della struttura, da rivestire in parte o totalmente.

Seattle is a chair that stands out for the careful craftsmanship of the leather upholstery. The seams and the punching are details of high tailoring, further highlighted by the light and almost aerial shape of the structure, to be upholstered in part or totally.









Nelle pagine precedenti: sedie Seattle con braccioli, seduta e gambe rivestite in cuoio sfoderabile 29 tortora. Tavolo Home Hotel con struttura e piano in olmo nero. Tappeto Frame perla. In questa pagina: sedia Seattle senza braccioli, seduta rivestita in cuoio sfoderabile 29 tortora, gambe in olmo nero. Sotto: dettaglio della punzonatura estetica (broguering) perimetrale alla seduta.

Previous pages: Seattle chairs with armrests, seat and legs covered in removable hide 29 tortora. Home Hotel table with structure and top in black elm. Carpet Frame perla. This page: Seattle chair without armrests, seat covered in removable hide 29 tortora, black elm legs. Below: close-up of the perimeter decorative punching (broguing) of the seat.





In questa pagina: sedia Seattle con braccioli, seduta e gambe rivestite in cuoio sfoderabile 02 nero. Nella pagina successiva: sedie Seattle con e senza braccioli, seduta rivestita in cuoio sfoderabile 26 invecchiato, gambe in olmo nero. Tavolo Blade con struttura e piano in massello tinto olmo nero.

This page: Seattle chair with armrests, seat and legs covered in removable hide 02 nero. Next page: Seattle chairs with and without armrests, seat covered in removable hide 26 invecchiato, black elm legs. Blade table with structure and top in solid wood stained black elm.







## SEATTLE

Design Jean-Marie Massaud, 2015

Seduta in poliuretano integrale con inserto in metallo. Seduta e schienale completamente rivestite in cuoio sfoderabile con punzonatura estetica (broguering) perimetrale. Gambe in massello, finitura in rovere spessart, olmo nero o completamente rivestite in cuoio colori.

Seat in integral polyurethane with metal insert. Seat and backrest fully covered in removable hide with perimeter decorative punching (broguing). Legs in solid wood in the finishes spessart oak, black elm or fully covered in hide in the available colours.

### Gambe in essenza Legs in wood

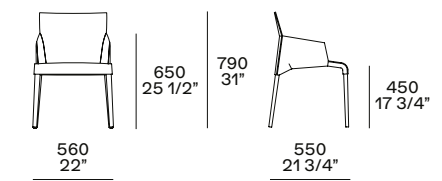
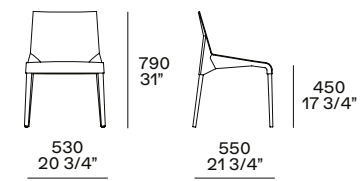

### Gambe in cuoio Legs in hide

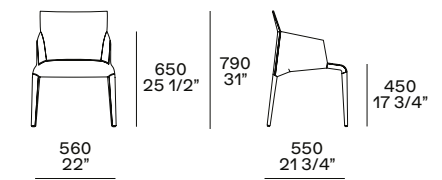
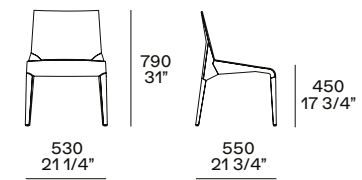



# IPANEMA



Originale e raffinata, la sedia Ipanema, firmata da Jean-Marie Massaud, è decisamente versatile: la particolare struttura in essenza, con o senza braccioli, si può abbinare a tutti i tessuti e le pelli della collezione.

Original and refined, the Ipanema chair, signed by Jean-Marie Massaud, is markedly versatile: the particular structure in wood, with or without armrests, can be combined with all the fabrics and leathers of the collection.







Qui e nella pagina precedente: sedie Ipanema con braccioli, rivestimento non sfoderabile in pelle Soft 4 cognac, struttura in olmo nero. Tavolo Home Hotel in olmo nero con piano centrale girevole integrato in marmo noir saint laurent lucido. Tappeto Plain tortora.

This and previous page: Ipanema chairs with armrests, non-removable cover in leather Soft 4 cognac, black elm structure. Home Hotel table in black elm with integrated swivel top in glossy marble noir saint laurent. Carpet Plain tortora.



In questa pagina: sedia Ipanema con braccioli, rivestimento non sfoderabile in tessuto Corinto 02 fango, struttura in olmo nero.

This page: Ipanema chair with armrests, non-removable cover in fabric Corinto 02 fango, black elm structure.

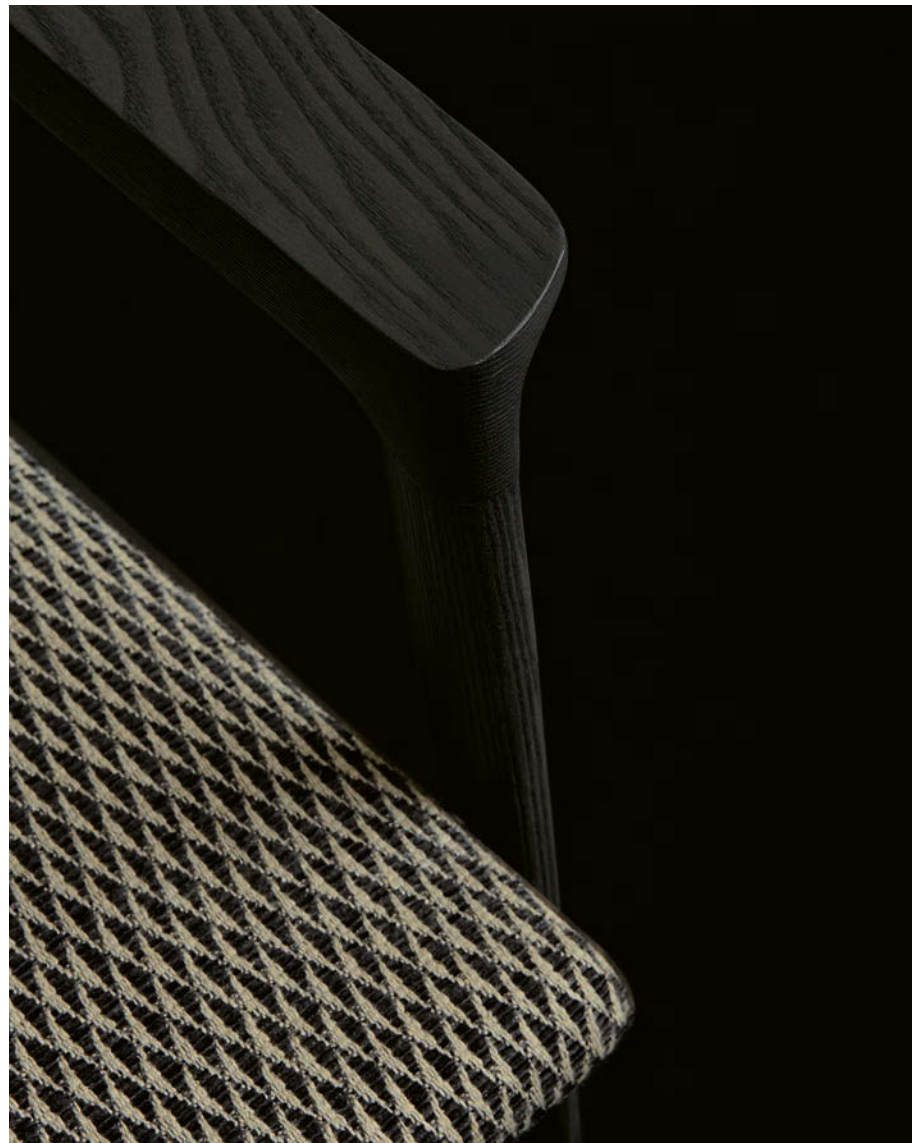



In questa pagina: sedia Ipanema senza braccioli, rivestimento non sfoderabile in pelle Soft 01 crema, struttura in olmo nero. Nella pagina successiva: sedie Ipanema con e senza braccioli, rivestimento non sfoderabile in pelle Special 66 cedro, struttura in olmo nero. Tavolo Howard in olmo nero con piano in marmo emperador dark levigato. Boiserie Quid in olmo nero e profili verniciato brown nickel opaco, mensole lacato opaco piombo e cuoio 29 tortora. Tappeto Frame grey.

This page: Ipanema chair without armrests, cover in non-removable leather Soft 01 crema, black elm structure. Next page: Ipanema chairs with and without armrests, non-removable cover in leather Special 66 cedro, black elm structure. Howard table in black elm with top in mat marble emperador dark. Wall panelling Quid in black elm with mat brown nickel painted profiles, piombo mat lacquered shelves covered in hide 29 tortora. Carpet Frame grey.

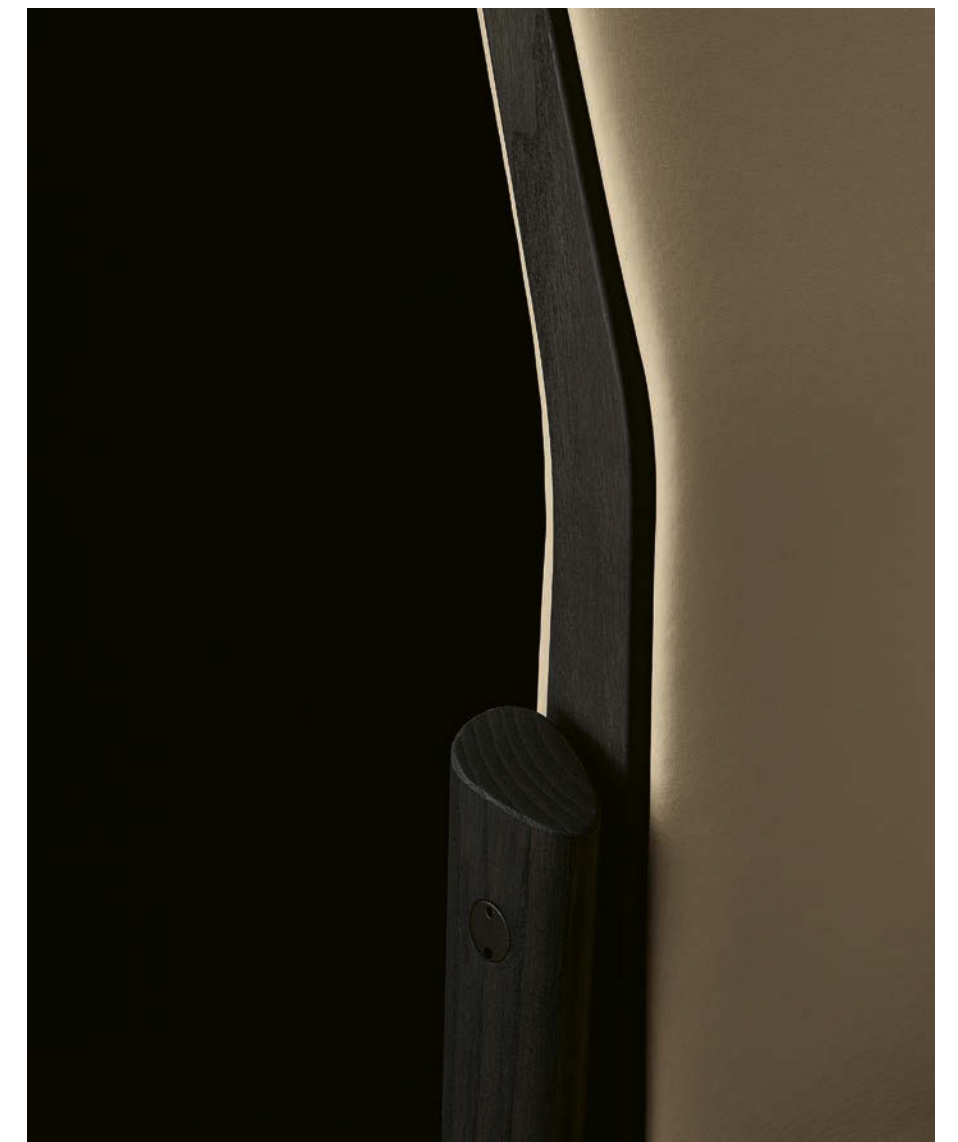





## IPANEMA

Design Jean-Marie Massaud, 2015

Seduta e schienale in poliuretano flessibile stampato, rivestimento non sfoderabile in tessuto o pelle. Struttura in massello, finitura in rovere spessart o olmo nero.

Seat and backrest in moulded flexible polyurethane, cover in non-removable fabric or leather. Structure in solid wood in the finishes spessart oak or black elm.

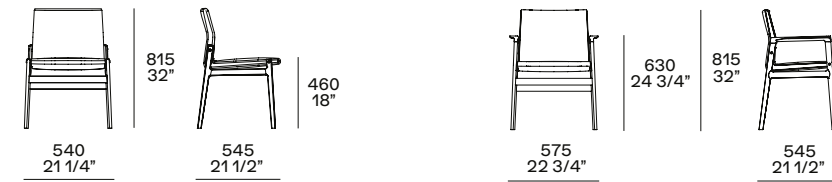

# MANTA





Linee essenziali per una sedia che invita e accoglie, in due versioni, con e senza braccioli. Totalmente imbottita e rivestita, Manta è perfetta attorno a tavoli importanti, ma per la sua presenza di carattere può essere usata anche da sola, in combinazione con uno scrittoio.

Essential lines for a chair that invites and welcomes, in two versions, with and without armrests. Entirely padded and upholstered, Manta is perfect around important tables, but due to its presence of character, it can also be used by itself, combined with a writing desk.



Nella pagina precedente: sedia Manta con braccioli, rivestimento non sfoderabile in pelle Silk 10 terracotta. Tavolo Mondrian con piano in marmo levigato sahara noir finitura poliestere e struttura in brown nickel opaco. Sistema Code, ante in laccato metallico bronzo e in vetro trasparente riflettente, top retroilluminato in marmo zecevo levigato, vetrine e vani a giorno con schienali in tessuto lino chiaro. Tappeto Tratto ruggine. In questa pagina: sedia Manta con braccioli, rivestimento non sfoderabile in pelle Special 39 panna.

Previous page: Manta chair with armrests, cover in non-removable leather Silk 10 terracotta. Mondrian table with top in mat marble sahara noir, polyester finish and mat brown nickel structure. Code system, doors in metal lacquer bronze and in transparent reflecting glass, backlit top in mat marble zecevo, display cases units and open compartments with backs in fabric lino chiaro. This page: Manta chair with armrests, cover in non-removable leather Special 39 panna.







In questa pagina: sedia Manta senza braccioli, rivestimento non sfoderabile in tecnocover Pixel colore nero. Nella pagina successiva: sedia Manta con braccioli, rivestimento non sfoderabile in pelle Silk 10 terracotta. Tavolo Mondrian con piano in marmo levigato sahara noir finitura poliestere e struttura in brown nickel opaco. Sistema Code, ante in laccato metallico bronzo e in vetro trasparente riflettente, top retroilluminato in marmo zecevo levigato, vetrine e vani a giorno con schienali in tessuto lino chiaro. Tappeto Tratto ruggine.

This page: Manta chair without armrests, cover in non-removable Pixel tecnocover in black colour. Next page: Manta chair with armrests, cover in non-removable leather Silk 10 terracotta. Mondrian table with top in mat marble sahara noir, polyester finish and mat brown nickel structure. Code system, doors in metal lacquer bronze and in transparent reflecting glass, backlit top in mat marble zecevo, display cases units and open compartments with backs in fabric lino chiaro. Carpet Tratto ruggine.

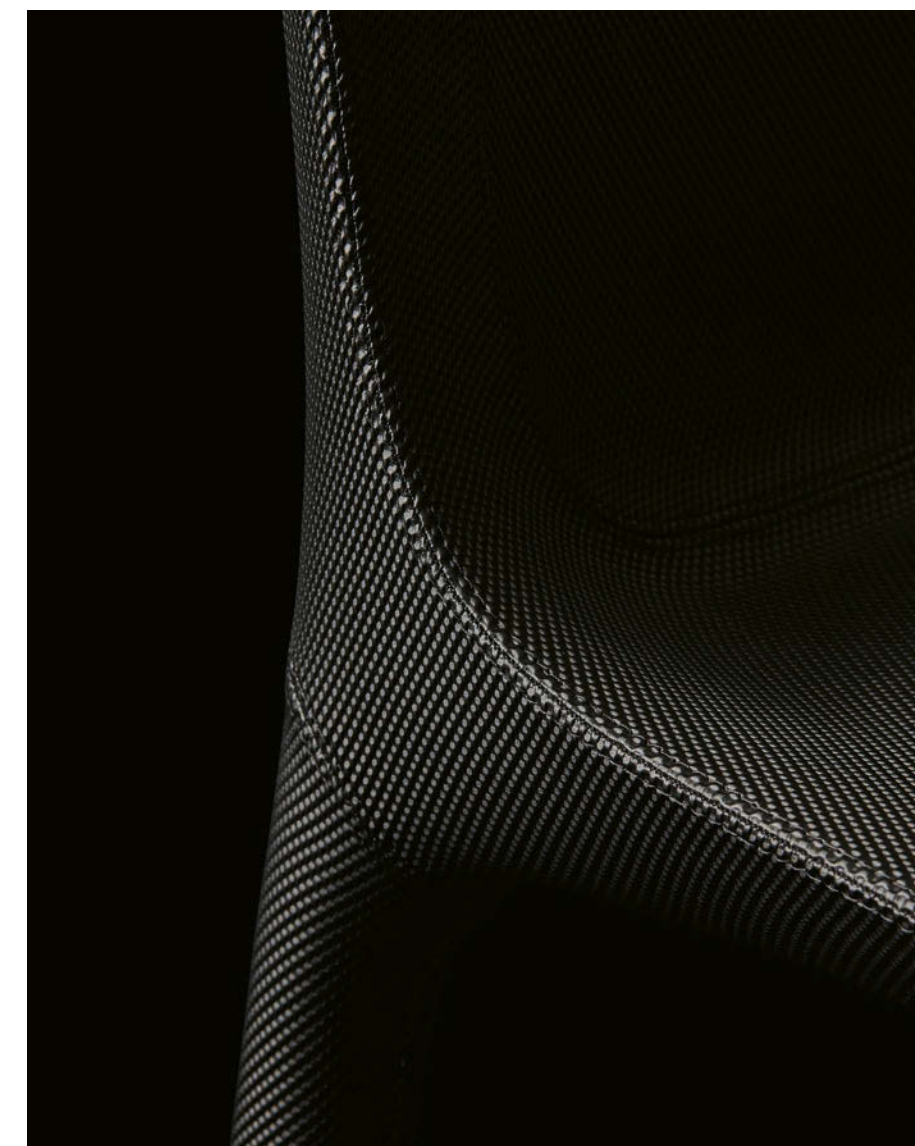



## MANTA

Design Rodrigo Torres, 2007

Struttura in poliuretano flessibile stampato con telaio in metallo. Seduta e gambe completamente rivestite. Rivestimento non sfoderabile in pelle o in tecnocover Pixel gofrata colore nero.

Structure in flexible moulded polyurethane with metal frame. Seat and legs fully covered. Non-removable cover in leather or in embossed Pixel tecnocover in black colour.

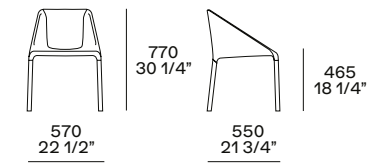
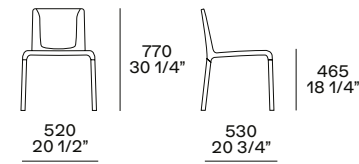



# GUEST





Rodolfo Dordoni disegna una sedia capace di suggerire – col suo nome e visivamente – l'idea di ospitalità e comfort. Per le sue proporzioni ampie e le linee morbide, più simile a una poltroncina che a una sedia, Guest è ideale attorno a un tavolo e perfetta anche da sola, accanto a uno scrittoio.

Rodolfo Dordoni designs a chair capable of suggesting – with its name and visually – the idea of hospitality and comfort. Because of its large proportions and soft lines, more similar to an armchair than a chair, Guest is ideal around a table and perfect even by itself, next to a writing desk.





Qui e nella pagina precedente: sedia Guest con rivestimento non sfoderabile in pelle Soft 10 prugna, cuscino seduta sfoderabile nella stessa finitura. Scrivitoio Mathieu con struttura brown nickel lucido e piano con cornice rovere spessart e inserto in cuoio 29 tortora. Cassetto sottopiano in laccato carbone e specchio con struttura brown nickel lucido. Nella pagina successiva: sedia Guest con rivestimento non sfoderabile in velluto Persia 2012 visone, cuscino seduta sfoderabile nella stessa finitura.

This and previous page: Guest chair with non-removable cover in leather Soft 10 prugna, seat cushion with removable cover in the same material. Mathieu writing desk with glossy brown nickel structure and tabletop with frame in spessart oak, insert in hide 29 tortora. Undermount drawer lacquered carbone and mirror with glossy brown nickel structure. Next page: Guest chair with non-removable cover in velvet Persia 2012 visone, seat cushion with removable cover in the same material.

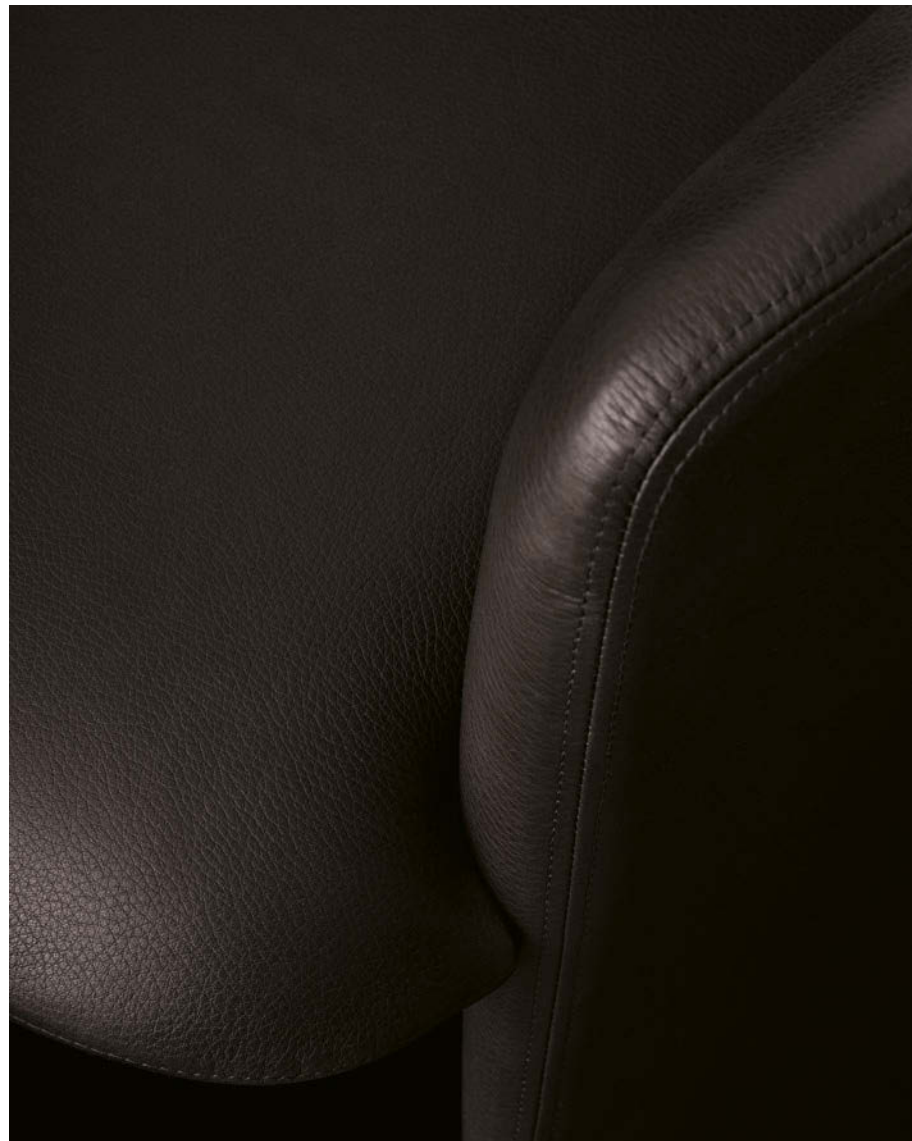



## GUEST

Design Rodolfo Dordoni, 2014

Scocca in poliuretano flessibile stampato con telaio in metallo, prriverstimento in fibra di poliestere. Rivestimento non sfoderabile in tessuto o pelle. Cuscino seduta con rivestimento sfoderabile in tessuto o pelle. Ruote a scomparsa.

Body in flexible moulded polyurethane with metal frame, pre-cover in polyester fibre. Non-removable cover in fabric or leather. Seat cushion with removable cover in fabric or leather. Invisible wheels.

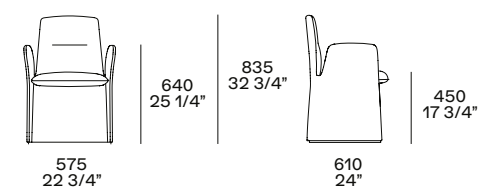



# BENCHES

Versatili e attuali, le panche possono completare un sistema di sedute o vivere autonomamente nei contesti più informali. Emmanuel Gallina immagina la panca come un pouf: imbottita e rivestita in tessuto, Jane è una confortevole seduta aggiuntiva per la zona giorno, ideale anche accanto a un tavolo. Jean-Marie Massaud predilige invece le linee essenziali e il calore del legno, e con Home Hotel trasforma la classica panca in un elemento di grande eleganza per tutti gli ambienti della casa.

Versatile and modern, benches can complete a seating system or live independently in more informal settings. Emmanuel Gallina imagines the bench as a pouf: padded and upholstered in fabric, Jane is a comfortable additional seat for the day area, also ideal next to a table. Jean-Marie Massaud instead favours minimalistic lines and the warmth of wood, and with Home Hotel transforms the classic bench into an element of great elegance for all the environments of the house.

## BENCHES

JANE

121

HOME HOTEL

129



# JANE

Disegnata da Emmanuel Gallina, Jane è una collezione di elementi imbottiti dalle dimensioni contenute. Elegante ed essenziale, la panca ha una seduta imbottita e una struttura sottile e dinamica con piedi in metallo oppure in essenza, che la rendono perfetta accanto a un tavolo così come negli ambienti di passaggio.

Designed by Emmanuel Gallina, Jane is a collection of padded elements of small dimensions. Elegant and minimalistic, the bench has a padded seat and a slim and dynamic structure with metal or wood feet, which make it perfect next to a table as well as in passageways.





Nella pagina introduttiva: panca Jane con rivestimento sfoderabile in pelle Nabuk 06 mastice, struttura brown nickel lucido. Nella pagina precedente: panca Jane con rivestimento sfoderabile in tessuto Orleans 12 carbone, struttura brown nickel lucido. Sedie Sophie senza braccioli, rivestimento non sfoderabile in pelle Soft 14 oliva, struttura in olmo nero. Tavolo Concorde con struttura e cornice piano in olmo nero, piano in vetro lucido bordeaux. In questa pagina: poggiatesta Jane con rivestimento sfoderabile in pelle Deep 04 bruciato, struttura in noce gold. Nella pagina successiva: panca Jane con rivestimento sfoderabile in tessuto Naxos 21 roccia, struttura in olmo nero.

Introduction page: Jane bench with removable cover in leather Nabuk 06 mastice, glossy brown nickel structure. Previous page: Jane bench covered in removable fabric Orleans 12 carbone, glossy brown nickel structure. Sophie chairs without armrests, cover in non-removable leather Soft 14 oliva, and structure in black elm. Concorde table with structure and top frame in black elm, tabletop in glossy glass bordeaux. This page: Jane footrest covered in removable leather Deep 04 bruciato, gold walnut structure. Next page: Jane bench covered in removable fabric Naxos 21 roccia, black elm structure.





## JANE

Design Emmanuel Gallina, 2017

Seduta in poliuretano flessibile a quote differenziate, priverivestimento in fibra di poliestere. Rivestimento sfoderabile in tessuto o pelle. Struttura in massello, finitura noce gold, rovere spessart o olmo nero. Struttura in metallo verniciato brown nickel opaco o lucido.

Seat in flexible polyurethane in different densities, pre-cover in polyester fibre. Removable cover in fabric or leather. Structure in solid wood in the finishes gold walnut, spessart oak or black elm. Structure in mat or glossy brown nickel painted metal.

### Panca struttura in essenza Bench with structure in wood

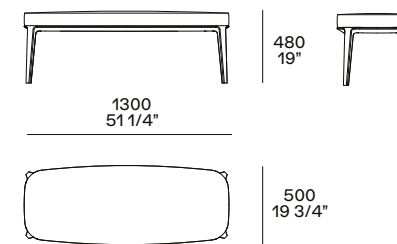

### Poggiapiedi struttura in essenza Footrest with structure in wood

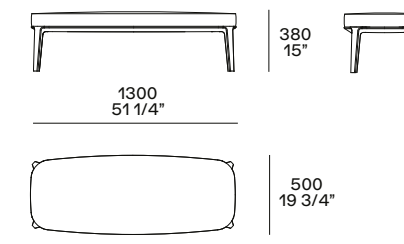

### Panca struttura in metallo Bench with structure in metal

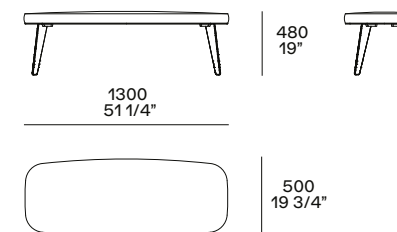

### Poggiapiedi struttura in metallo Footrest with structure in metal

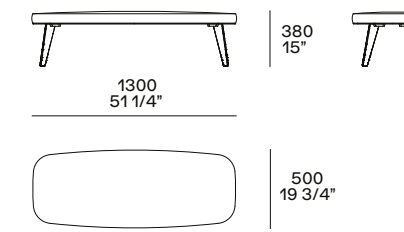





# HOME HOTEL



La collezione Home Hotel, disegnata da Jean-Marie Massaud, si compone di una serie di elementi dall'eleganza discreta, liberamente combinabili tra loro. Il nome stesso ne suggerisce la grande versatilità, che spazia dall'ambiente domestico ai luoghi dell'ospitalità. La panca è disponibile in diverse altezze e dimensioni, anche con seduta rivestita in cordatura di pelle.

The Home Hotel collection, designed by Jean-Marie Massaud, consists of a series of discrete elegance elements, freely combinable with each other. The name itself suggests its great versatility, ranging from the domestic environment to hospitality venues. The bench is available in different heights and sizes, even with a stringed leather seat.





Nella pagina precedente: panca Home Hotel struttura in olmo nero e seduta rivestita in cordatura di pelle testa di moro. In questa pagina: panca Home Hotel struttura e seduta a listelli in olmo nero. Cuscino con rivestimento sfoderabile in pelle Nabuk 01 latte e parte superiore in pelle Nabuk intrecciata 01 latte.

Previous page: Home Hotel bench structure in black elm and seat covered in dark brown stringed leather. This page: Home Hotel bench with structure and seat in black elm with slats. Cushion with removable cover in leather Nabuk 01 latte and upper side in woven leather Nabuk 01 latte.



In questa pagina: panca Home Hotel struttura in olmo nero e seduta rivestita in cordatura di pelle testa di moro.

This page: Home Hotel bench structure in black elm and seat covered in dark brown stringed leather.





In questa pagina: panca Home Hotel in olmo nero, vassoio in olmo nero con top in laccato lucido canapa. Nella pagina successiva: panca Home Hotel in olmo nero, cuscino in pelle Nabuk 02 tortora. Cabina armadio Ubik con pannelli a parete in nobilitato Skin laccato opaco 94 latte, attrezzature in nobilitato rovere cenere e ardesia opaco. Armadio Senzafine Skin con ante scorrevoli complanari in nobilitato Skin laccato opaco 94 latte.

This page: Home Hotel bench in black elm, tray in black elm with top in canapa glossy lacquer. Next page: Home Hotel bench in black elm, cushion in leather Nabuk 02 tortora. Ubik walk-in closet with wall mounted panels in 94 latte mat lacquered Skin melamine, equipment in cenere oak melamine and mat ardesia. Wardrobe Senzafine Skin with coplanar sliding doors in 94 latte mat lacquered Skin melamine.





## HOME HOTEL

Design Jean-Marie Massaud, 2016

Struttura e listelli piano in massello, finitura olmo nero. Seduta panche h 440 e poggiatesta in olmo nero rivestita in cordatura di pelle testa di moro. Seduta panche h 340 in olmo nero. Cuscino e vassoio opzionali per panche h 340. Cuscino con rivestimento sfoderabile in tessuto o pelle; nella versione pelle intrecciata possibilità di rivestimento solo della parte superiore. Vassoio in olmo nero con top in laccato lucido colori.

Structure and slats of the top in solid wood finish black elm. Benches seat h 17 1/4" and footrest in black elm, covered with dark brown stringed leather. Benches seat h 13 1/2" in black elm. Cushion and optional tray for benches h 13 1/2". Cushion with removable cover in fabric or leather; in the version with woven leather, only the upper side is available with this manufacturing. Tray in black elm with top in glossy lacquered colours.

### Panca h 440 Bench h 17 1/4"

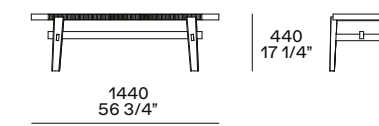
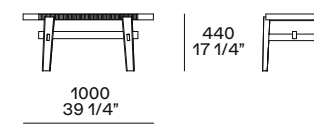

### Poggiatesta Footrest

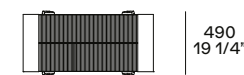
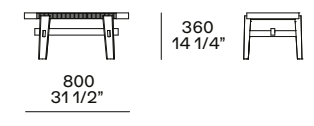

### Panca h 340 Bench h 13 1/2"

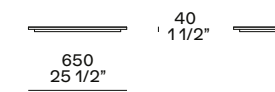
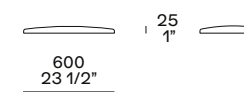
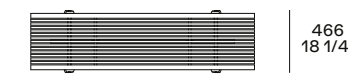
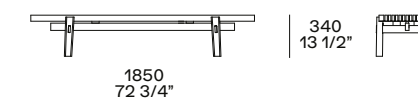

cuscino opzionale  
optional cushion

vassoio opzionale  
optional tray



# STOOLS

Un tempo riservati ai luoghi della convivialità, gli sgabelli sono diventati un complemento indispensabile accanto ai piani snack delle cucine contemporanee. Proprio in questa direzione vanno i progetti di Emmanuel Gallina, Jean-Marie Massaud e Rodrigo Torres, che ridisegnano le sedie lavorando sulle proporzioni e sul comfort della seduta, reso più complesso dalla verticalità. Dei modelli originari gli sgabelli mantengono il nome, così come le forme avvolgenti e la cura per i materiali e le lavorazioni.

Once reserved for places of conviviality, stools have become an indispensable complement next to the snack tops of contemporary kitchens. The projects of Emmanuel Gallina, Jean-Marie Massaud, and Rodrigo Torres go in this direction, redesigning the chairs working on the proportions and comfort of the seat, made more complex by the verticality. Of the original models the stools keep the name, as well as the enveloping shapes and attention for the materials and details.

## STOOLS

SEATTLE	145
SOPHIE LITE	155
VENTURA	165
ICS	175





# SEATTLE



La collezione di sedute Seattle, disegnata da Jean-Marie Massaud nel 2015, si completa con lo sgabello, dalle proporzioni ancora più eleganti. Come le sedie, anche lo sgabello si riconosce per la qualità della lavorazione del rivestimento in cuoio, con cuciture e punzonature ispirate alla tradizione calzaturiera britannica.

The Seattle chair collection, designed by Jean-Marie Massaud in 2015, is completed by the stool, with even more elegant proportions. Like the chairs, the stool too is distinguished by the quality of the hide covering manufacturing, with stitching and punching inspired by the British shoemaking tradition.





Nella pagina precedente e in chiusura: sgabelli Seattle con seduta e gambe rivestite in cuoio non sfoderabile 29 tortora e poggipiedi in cromo satinato. Cucina Alea Pro, isola centrale con estrattori, ante, fianchi di finitura e top in Inalco MDI® stone brown, profilo maniglia, sagoma e distanziali in anodizzato moka, piano snack Sydney in massello di noce canaletto. Colonne con ante ed estrattori in acciaio PVD bronzo con distanziali in anodizzato moka. Colonne con ante vetrina PR24 in anodizzato moka e vetro riflettente fumé, con struttura interna in noce canaletto naturale, illuminazione a led integrata. In questa pagina: sgabelli Seattle, nelle due versioni alta e bassa, entrambi con seduta e gambe rivestite in cuoio non sfoderabile 19 caffè.

Previous and closing page: Seattle stools with seat and legs covered in non-removable hide 29 tortora and footrest in brushed chrome. Alea Pro kitchen, central island with pull-out baskets, doors, finishing sides and worktop in Inalco MDI® stone brown, handle profile, profile and spacers anodized moka, Sydney snack worktop in solid walnut canaletto. Tall units with doors and pull-out baskets in PVD steel bronzo with anodized moka spacers. Tall units with glass doors PR24 anodized moka and fumé reflecting glass, with inner structure in natural walnut canaletto, integrated led light. This page: Seattle stools in the two versions, high and low, both with seat and legs covered in non-removable hide 19 caffè.

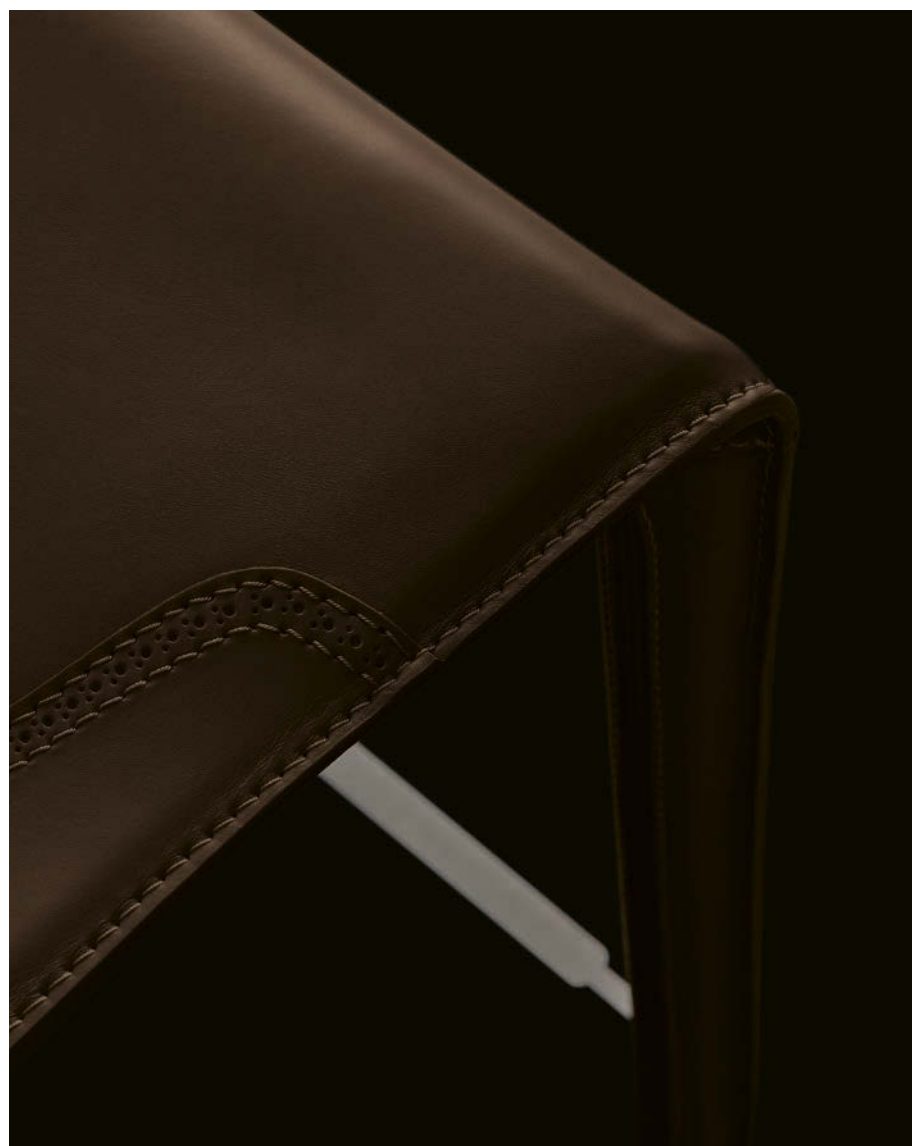



In questa pagina: sgabello Seattle, nella versione alta, seduta e gambe rivestite in cuoio non sfoderabile 26 invecchiato e poggipiedi in acciaio cromo satinato. Sotto: dettaglio dello sgabello Seattle che evidenzia la lavorazione con broguering.

This page: Seattle stool, in the high version, with seat and legs covered in non-removable hide 26 invecchiato and footrest in brushed chrome. Below: close up of the stool Seattle which highlights the broguering manufacturing.

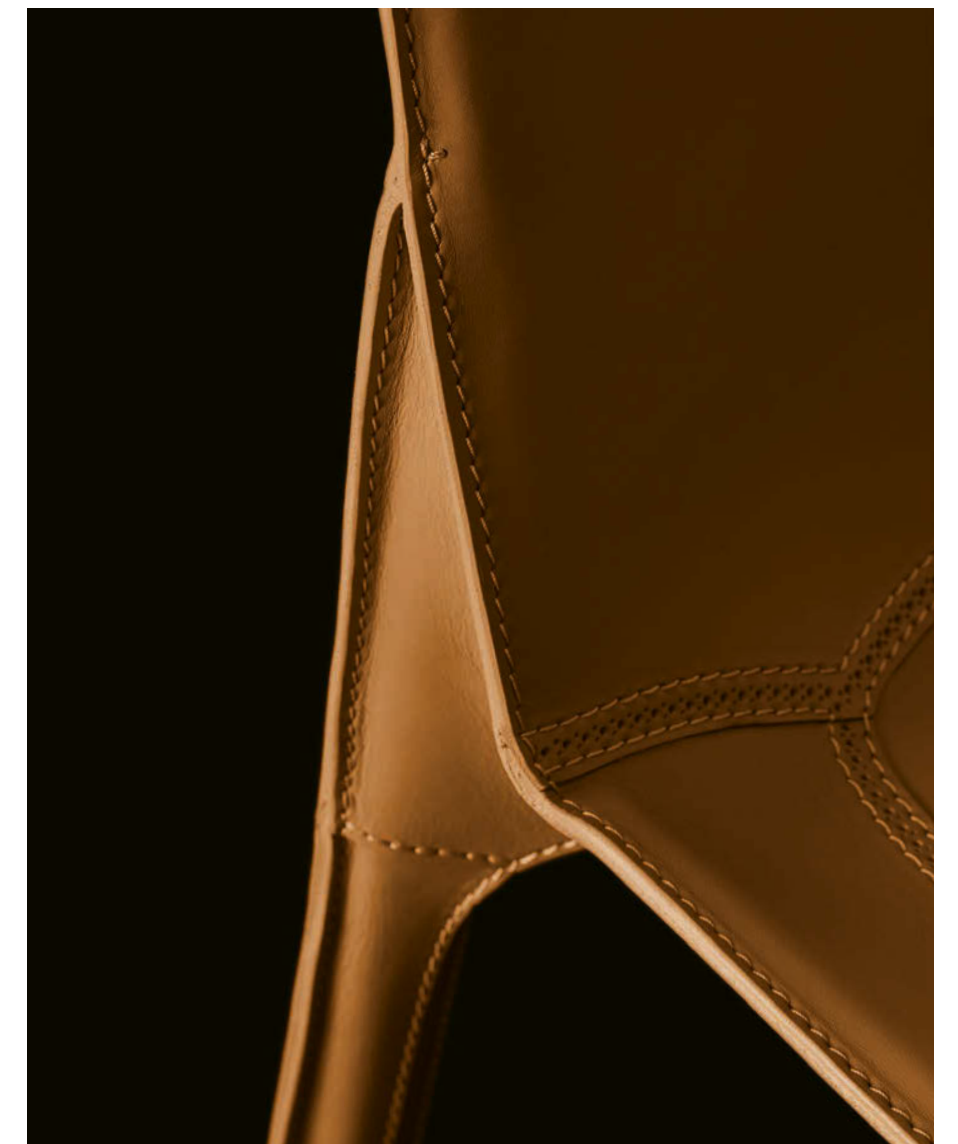





## SEATTLE

Design Jean-Marie Massaud, 2020

Seduta in poliuretano integrale con inserto in metallo, gambe in massello. Seduta, schienale e gambe completamente rivestite in cuoio non sfoderabile nei colori 19 caffè, 02 nero, 26 invecchiato o 29 tortora con punzonatura estetica (broguering) perimetrale. Poggiapiedi in cromo satinato.

Seat in integral polyurethane with metal insert, legs in solid wood. Seat and backrest fully covered in non-removable hide in the colours 19 caffè, 02 nero, 26 invecchiato or 29 tortora with perimeter decorative punching (broguering). Footrest in brushed chrome.

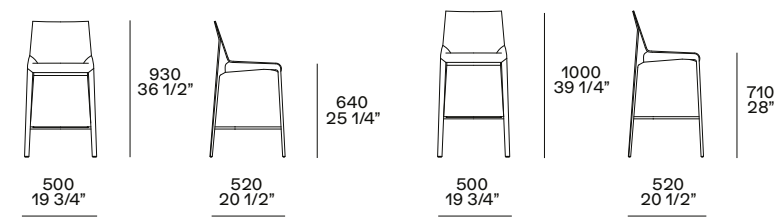

# SOPHIE LITE





Lo sgabello Sophie Lite reinterpreta la classica eleganza della sedia omonima in un elemento più alto e slanciato. Restano il disegno delicato del bracciolo e la seduta generosa, mentre la struttura in massello si arricchisce del poggiapiedi, dettaglio funzionale e di stile. La seduta, imbottita, si può rivestire in tessuto o pelle.

The Sophie Lite stool reinterprets the classic elegance of the chair that shares the same name in a taller, sleeker version. The delicate design of the armrest and the generous seat are retained, while the solid wood structure is further enhanced by the functional and stylish detail of the footrest. The padded seat can be upholstered in fabric or leather.





Nella pagina precedente: sgabelli Sophie Lite in olmo nero con poggiatesta in brown nickel opaco e seduta rivestita in tessuto sfoderabile Arcadia 05 bronzo. Snack Lama con piano in olmo nero, gamba e supporto in laccato goffrato moka. In questa pagina: sgabello Sophie Lite, rivestimento sfoderabile in tessuto Antea 03 visone, struttura in rovere spessart e poggiatesta in brown nickel opaco.

Previous page: Sophie Lite stools in black elm with footrest in mat brown nickel and seat covered in removable fabric Arcadia 05 bronze. Snack Lama with top in black elm, leg and support in moka embossed lacquer. This page: Sophie Lite stool, removable cover in fabric Antea 03 visone, structure in spessart oak and footrest in mat brown nickel.







In questa pagina: sgabello Sophie Lite con rivestimento sfoderabile in pelle Nabuk 03 cervo, struttura in olmo nero e poggiatesta in brown nickel opaco. Nella successiva: sgabelli Sophie Lite in olmo nero con poggiatesta in brown nickel opaco e seduta rivestita in tessuto sfoderabile Arcadia 05 bronzo. Cucina Alea Pro, basi con ante ed estrattori in rovere gold, top in laminato tuttocolore touch acciaio. Snack Lama con piano in olmo nero, gamba e supporto in laccato goffrato moka. Pensili con ante in LCT silver gray. Sotto ai pensili, Deep Shaker in anodizzato moka e schienali in rovere gold.

This page: Sophie Lite stool with removable cover in leather Nabuk 03 cervo, structure in black elm and footrest in mat brown nickel. Next page: Sophie Lite stools in black elm with footrest in mat brown nickel and seat covered in removable fabric Arcadia 05 bronzo. Alea Pro kitchen, base units with doors and pull-out baskets in gold oak, top in laminate tuttocolore touch acciaio. Snack Lama with top in black elm, leg and support in moka embossed lacquer. Wall units with doors in LCT silver gray. Under the wall units, Deep Shaker in anodized moka and backs in gold oak.

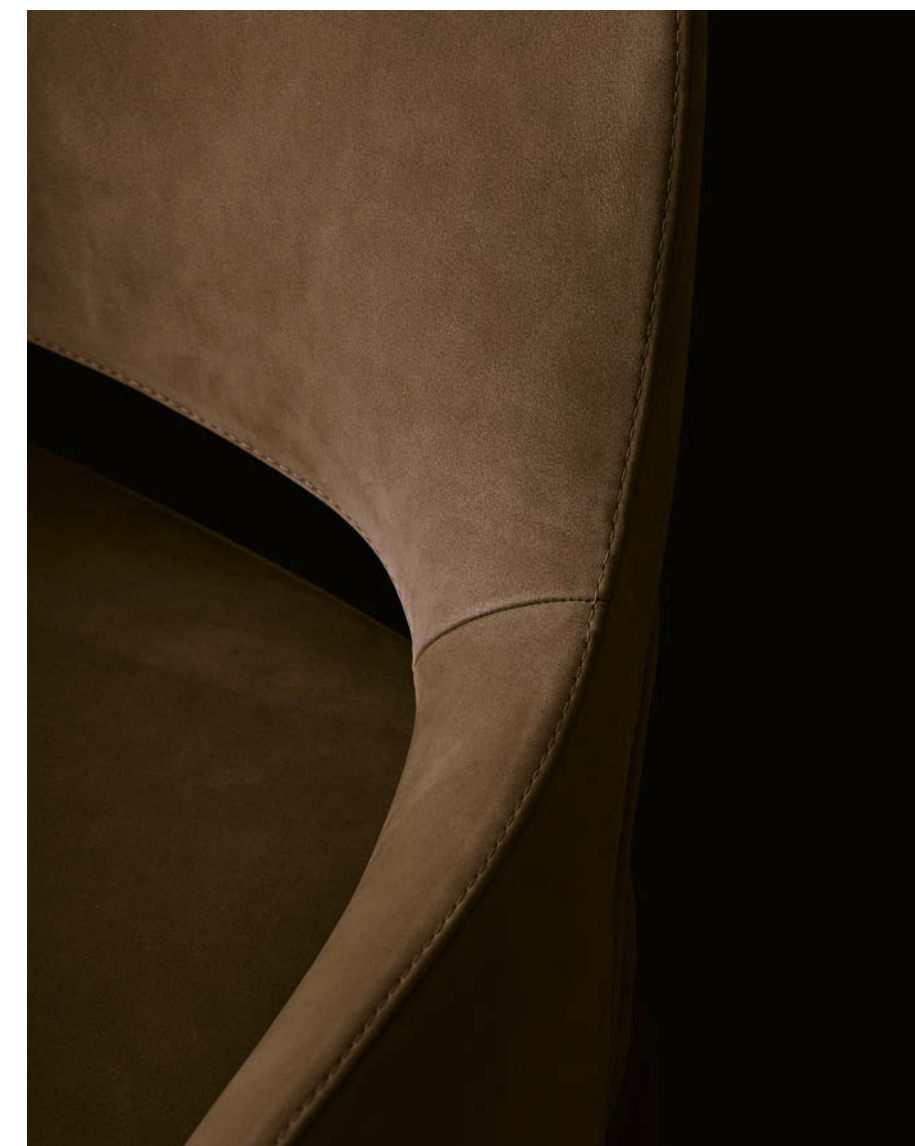



**SOPHIE LITE**  
Design Emmanuel Gallina, 2020

Seduta e schienale con parti in poliuretano flessibile a quote differenziate e parti in poliuretano flessibile stampato, prerivestimento in fibra di poliestere. Rivestimento sfoderabile in tessuto o pelle. Struttura in massello, finitura in rovere spessart, olmo nero o noce gold. Poggiapiedi in metallo verniciato brown nickel opaco.

Seat and backrest with parts in flexible polyurethane in different densities and parts in flexible moulded polyurethane, pre-cover in polyester fibre. Removable cover in fabric or leather. Structure in solid wood, spessart oak, black elm or gold walnut finish. Footrest in mat brown nickel painted metal.

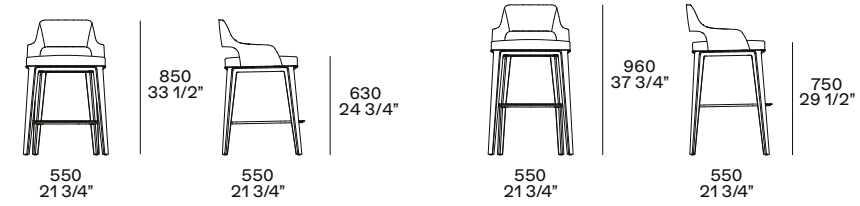





# VENTURA



Dell'omonima collezione di sedute, lo sgabello riprende la caratteristica struttura. Pensato per completare le cucine più attuali, Ventura riesce a coniugare contemporaneità e comfort grazie allo schienale e all'imbottitura, da rivestire a piacere in tessuto o pelle.

From the homonymous collection of seats, the stool borrows the characteristic structure. Designed to complete the most modern kitchens, Ventura manages to combine modernity and comfort thanks to the backrest and the padding, to be upholstered in fabric or leather.





Nella pagina precedente: sgabello Ventura con rivestimento non sfoderabile in pelle Soft 04 cognac, struttura in olmo nero e poggiatesta in acciaio inox. Cucina Phoenix, basi in acciaio con piano snack Blade in olmo nero. In questa pagina: sgabello Ventura con rivestimento non sfoderabile in pelle Soft 09 bulgaro, cucitura normale doppia, struttura in rovere spessart e poggiatesta in acciaio inox.

Previous page: Ventura stool with non-removable cover in leather Soft 04 cognac, black elm structure and footrest in stainless steel. Phoenix kitchen, base units in steel with Blade snack top in black elm. This page: Ventura stool with non-removable cover in leather Soft 09 bulgaro, normal double stitching, structure in spessart oak and footrest in stainless steel.





In questa pagina: sgabello Ventura con rivestimento non sfoderabile in tessuto Zante 10 nero, cucitura a cordoncino in tinta, struttura in olmo nero e poggiatesta in acciaio inox. Nella pagina successiva: sgabello Ventura con rivestimento non sfoderabile in pelle Soft 04 cognac, struttura in olmo nero e poggiatesta in acciaio inox. Cucina Phoenix, basi in acciaio con piano snack Blade in olmo nero. Cappa Factory in acciaio. Colonne con ante in olmo nero.

This page: Ventura stool with non-removable cover in fabric Zante 10 nero, drawstring stitching in matching colour, structure in black elm and footrest in stainless steel. Next page: Ventura stool with non-removable cover in leather Soft 04 cognac, structure in black elm and footrest in stainless steel. Phoenix kitchen, base units in steel with Blade snack top in black elm. Factory hood in steel. Tall units with doors in black elm.

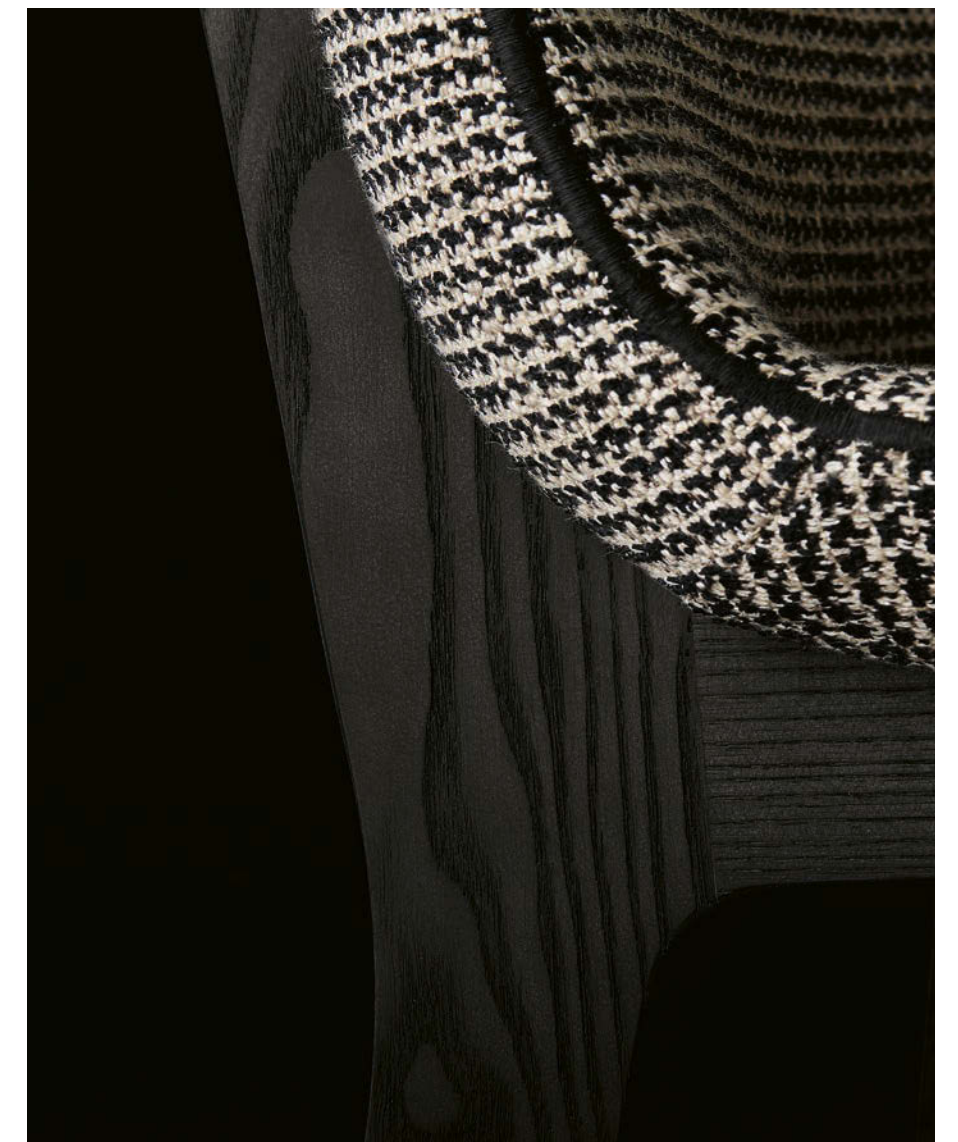





## VENTURA

Design Jean-Marie Massaud, 2016

Scocca in poliuretano flessibile stampato, priverivestimento in fibra di poliestere. Rivestimento non sfoderabile in tessuto o pelle. Cucitura normale doppia o, solo per la versione in tessuto (escluso velluto), cucitura a cordoncino in tinta. Struttura in massello, finitura rovere spessart o olmo nero. Poggiapiedi in legno e acciaio inox.

Body in moulded flexible polyurethane, pre-cover in polyester fibre. Non-removable cover in fabric or leather. Normal double stitching or drawstring stitching in matching colour only for the fabric version (except velvet). Structure in solid wood, spessart oak or black elm finish. Footrest in wood and stainless steel.

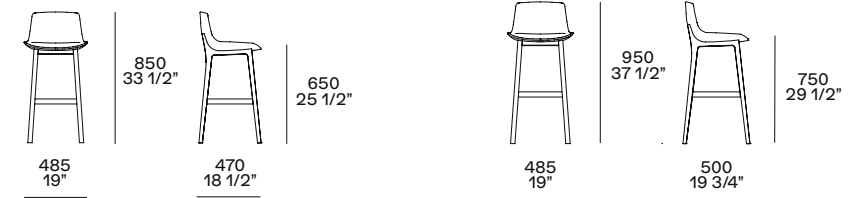

# ICS



Perfetto connubio tra essenzialità e solidità, Ics è uno sgabello in legno con sedile quadrato e quattro gambe inclinate e solide. Le forme del sedile sono rese più gentili dagli angoli smussati, quelle delle gambe dalla particolare lavorazione curva.

Ics is a wooden stool with square seat and four inclined and solid legs which creates a perfect combination of essentiality and solidity. The shapes of the seat are made gentler by the rounded corners, those of the legs by the particular curved workmanship.

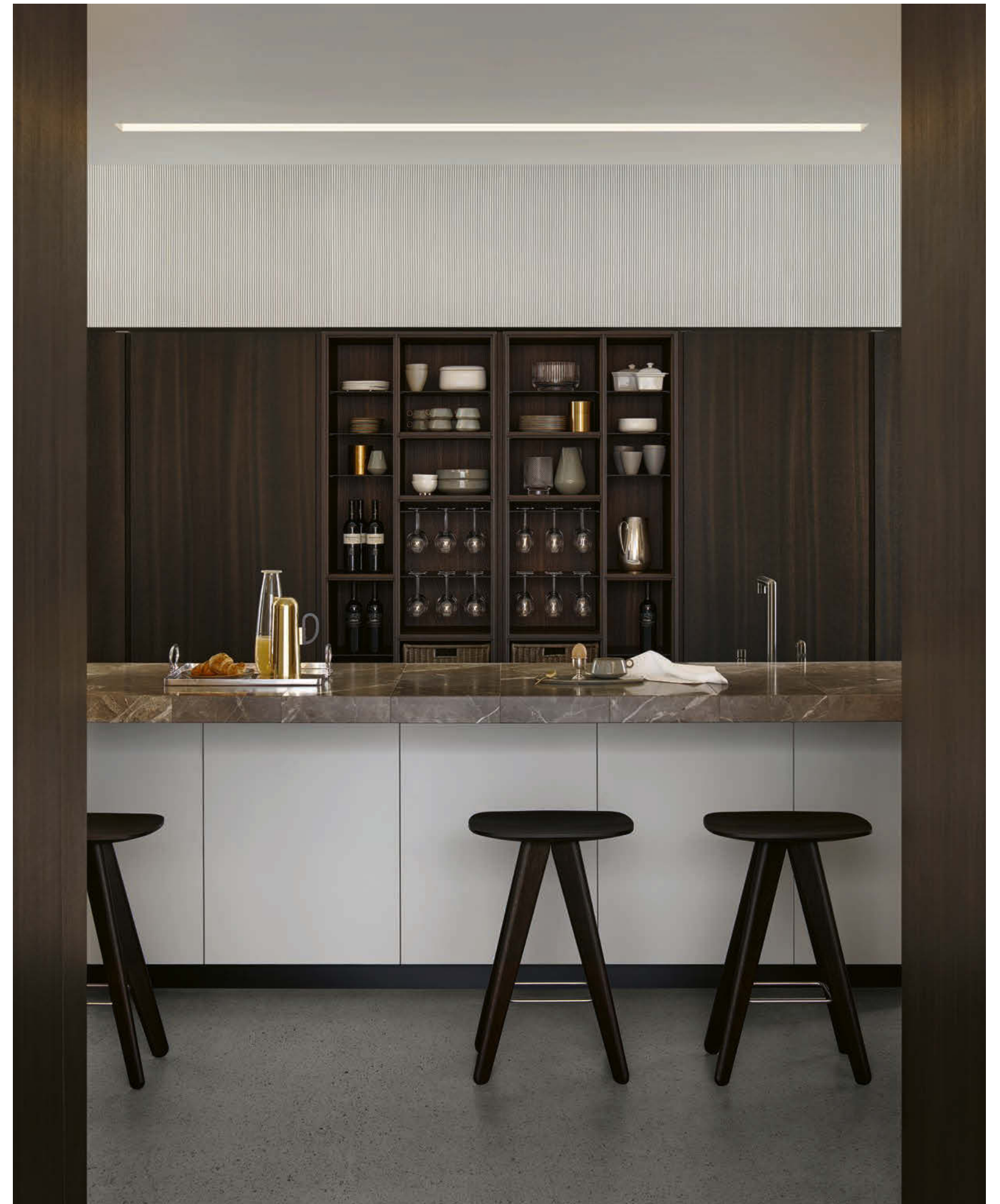

In questa pagina, nella precedente e nella successiva: sgabelli Ics con seduta e struttura in rovere spessart, poggiatesta in acciaio inox. Cucina Alea, isola con piano snack, basi con ante in laccato goffrato ghiaccio e top in DuPont Corian® pearl gray. Basi con ante ed estrattori in rovere spessart, top e schienali in pietra stone brown levigata. Cappa Flat verniciata nera a isola personalizzata Poliform. Colonne con ante e vani a giorno in rovere spessart.

This, previous and next page: Ics stools with seat and structure in spessart oak, footrest in stainless steel. Alea kitchen, island with snack top, base units with doors in embossed lacquered ghiaccio, top in DuPont Corian® pearl gray. Base units with doors and pull-out storage baskets in spessart oak, top and back panels in stone brown mat finishing. Poliform personalized Flat island-hood painted black. Tall units with doors and open compartments in spessart oak.







## ICS

Design Rodrigo Torres, 2010

Seduta in rovere spessart. Struttura in massello, finitura rovere spessart. Poggiapiedi in acciaio inox.

Seat in spessart oak. Structure in solid wood, spessart oak finish. Footrest in stainless steel.

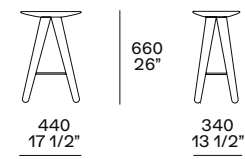

# TABLES



Una collezione nel segno della continua ricerca estetica, che esplora gli stili e le ispirazioni più diverse. Con un'eccezionale varietà di materiali e finiture, dalle dimensioni più importanti o contenute, le proposte di Poliform vanno dalle più classiche – come quelle firmate da Jean-Marie Massaud e Emmanuel Gallina – a quelle più versatili – come i tavoli disegnati da Roberto Barbieri. Elementi cardine dell'area conviviale, i tavoli si rivelano adatti a tutti gli spazi di casa.

A collection in the name of continuous aesthetic research, which explores the most diverse styles and inspirations. With an exceptional variety of materials and finishes, from big to small dimensions, Poliform's offers range from the most classic – such as those signed by Jean-Marie Massaud and Emmanuel Gallina – to the most versatile ones – such as the tables designed by Roberto Barbieri. Cardinal elements of the convivial area, the tables are suitable for all the environments of the house.

## TABLES

MONDRIAN	187
HENRY	203
CONCORDE	219
KENSINGTON	239
HOME HOTEL	257
FLUTE	277
HOWARD	287
BLADE	299
TREVI	311

# MONDRIAN





Jean-Marie Massaud reinterpreta il design leggero ed elegante della collezione Mondrian nel tavolo da pranzo. Tre le varianti del piano, ovale, rettangolare o rotondo, in legno, vetro o marmo. La particolare base in metallo può essere declinata in due tonalità.

Jean-Marie Massaud reinterprets the light and elegant design of the Mondrian collection with the dining table. Three variants of the top, oval, rectangular or round, in wood, glass, or marble. The particular metal base is available in two colours.











Qui, nelle pagine precedenti e in chiusura: tavolo Mondrian con piano in marmo sahara noir levigato finitura poliestere e struttura in brown nickel opaco. Sedie Manta con braccioli, rivestimento non sfoderabile in pelle Silk 10 terracotta. Sistema Code, ante in laccato metallico bronzo e in vetro trasparente riflettente, top retroilluminato in marmo zecevo levigato, vetrine e vani a giorno con schienali in tessuto lino chiaro. Tappeto Tratto ruggine.

This, previous pages and closing page: Mondrian table with top in mat marble sahara noir, polyester finish and mat brown nickel structure. Manta chairs with armrests, cover in non-removable leather Silk 10 terracotta. Code system, doors in metal lacquer bronzo and in transparent reflecting glass, backlit top in mat marble zecevo, display cases units and open compartments with backs in fabric lino chiaro. Carpet Tratto ruggine.



In questa pagina: tavolo Mondrian con piano in noce gold e struttura in champagne opaco.

This page: Mondrian table with top in gold walnut and structure in mat champagne.

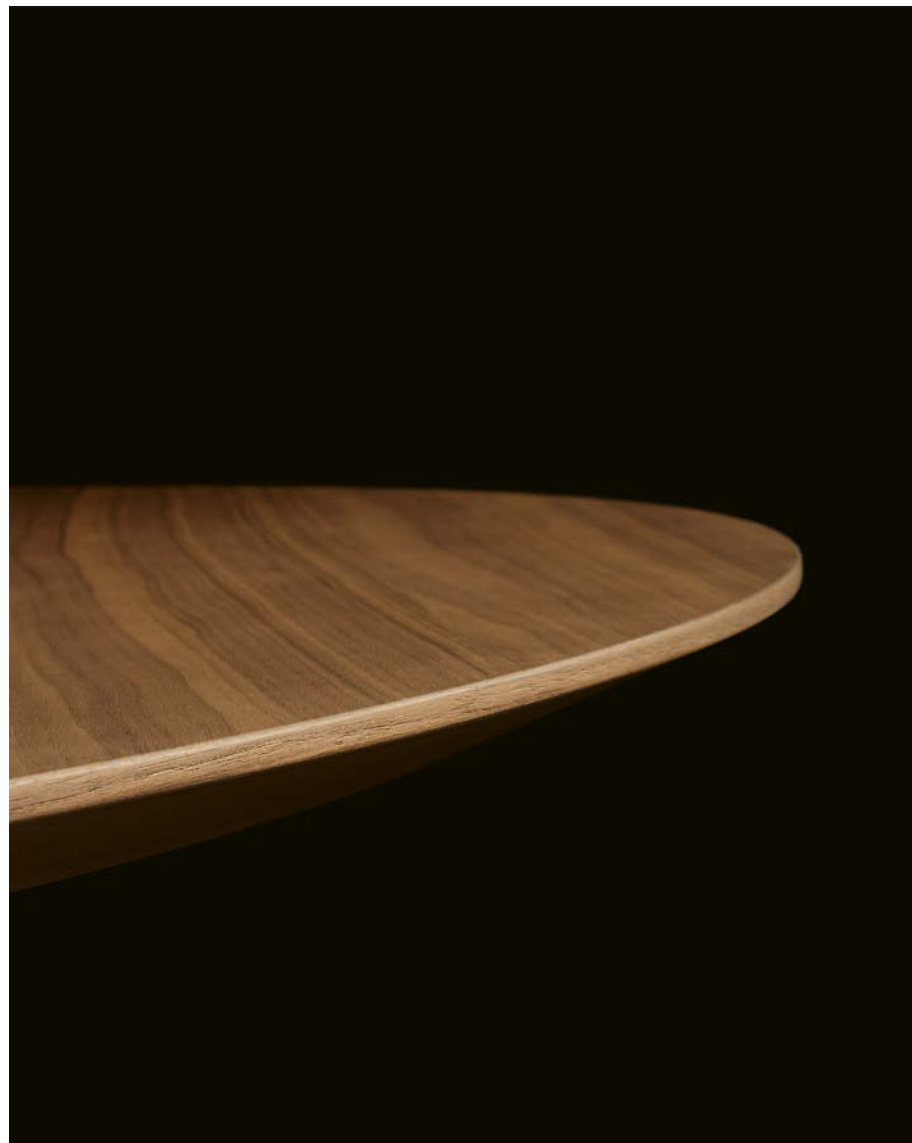







Nella pagina precedente: tavolo Mondrian con piano in marmo calacatta oro levigato e struttura in champagne opaco. In questa pagina: tavolo Mondrian con piano in vetro fumé e struttura in brown nickel opaco.

Previous page: Mondrian table with top in mat marble calacatta oro and structure in mat champagne. This page: Mondrian table with top in fumé glass and mat brown nickel structure.

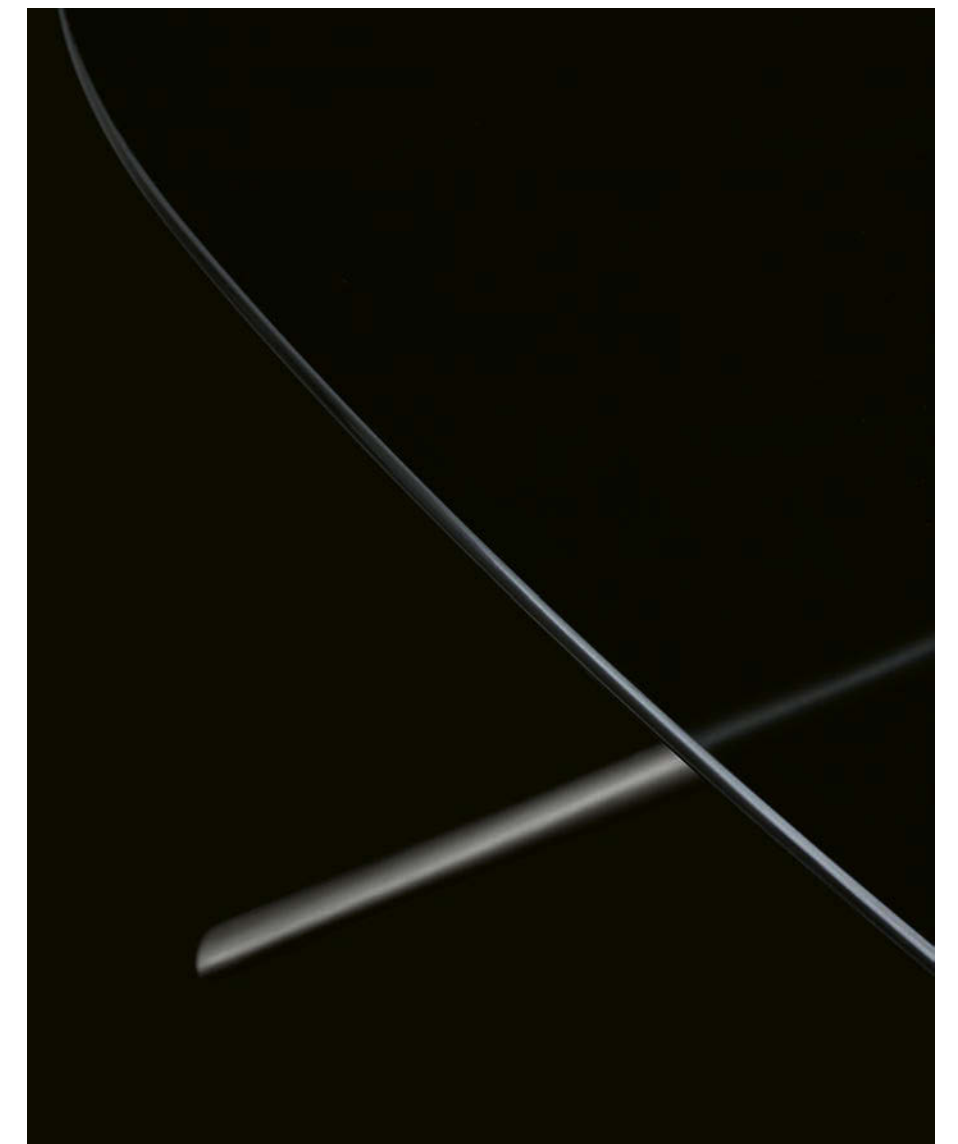





## MONDRIAN

Design Jean-Marie Massaud, 2019

Struttura in fusione di alluminio verniciato brown nickel opaco o champagne opaco. Piano in olmo nero, noce gold, rovere spessart (escluso ovale l 2150, Ø 1400) o marmo levigato e lucido (escluso zecevo). Disponibile anche con piano in vetro fumé escluso ovale l 2150, Ø 1400 e rettangolare l 3200. Per il tavolo Ø 1650 in essenza o marmo è disponibile il vassoio girevole, opzionale in appoggio, in laccato opaco colori, noce gold, rovere spessart, olmo nero o marmo levigato e lucido (escluso zecevo).

Structure in aluminium casting painted mat brown nickel or mat champagne. Top in black elm, gold walnut, spessart oak (except oval w 84 3/4") or mat and glossy marble (except zecevo). Available also with top in fumé glass except oval w 84 3/4", Ø 55" and rectangular w 126". For the table Ø 65" in wood or marble an optional spinning tray placed on top is available, finishes mat lacquered colours, gold walnut, spessart oak, black elm or mat and glossy marble (except zecevo).

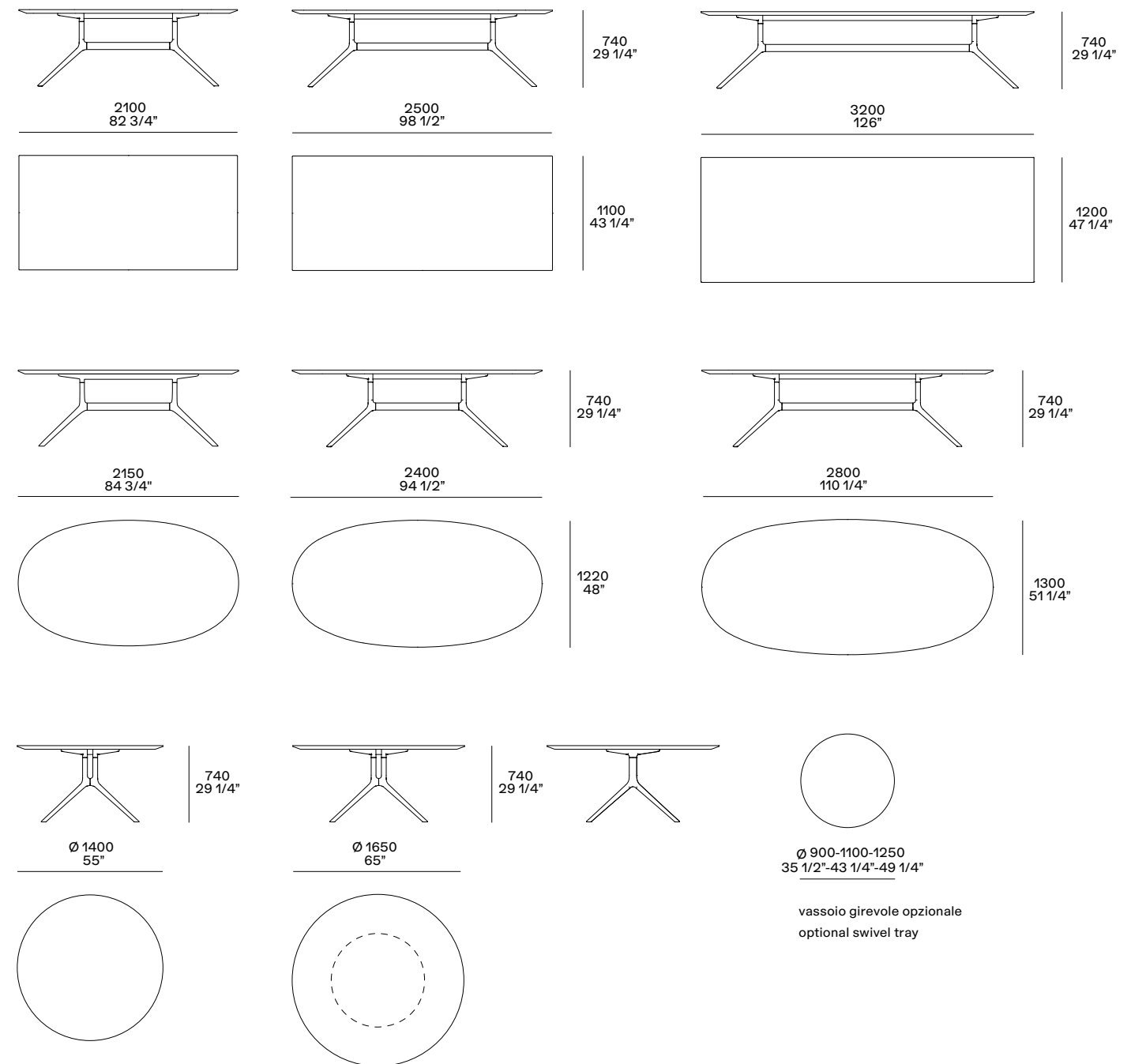



# HENRY



Henry è un tavolo da pranzo allungabile dalle dimensioni importanti, pensato per i momenti di convivialità. Eleganti le finiture: la struttura, in legno massello e caratterizzata da una raffinata lavorazione di ebanisteria, si abbina al piano rettangolare in legno, marmo o vetro.

Henry is an extendable dining table with important dimensions, designed for moments of conviviality. The elegant finish of the structure, in solid wood and distinguished by a refined cabinet-making workmanship, is combined with the rectangular top in wood, marble or glass.









Nelle pagine precedenti e in chiusura: tavolo Henry in olmo nero con piano in marmo sahara noir levigato finitura poliesteri. Sedie Sophie Lite con braccioli, rivestimento sfoderabile in tessuto Antea 03 visone e struttura in olmo nero. Madia Symphony in rovere gold con top in marmo levigato sahara noir finitura poliesteri, maniglia e basamento con piedini in brown nickel opaco. Tappeto Cannelé. In questa pagina: tavolo Henry in olmo nero con piano in vetro lucido bordeaux. Nella pagina successiva: tavolo Henry in noce gold con piano in marmo calacatta oro levigato.

Previous pages and closing page: Henry table in black elm with top in mat marble sahara noir with polyester finish. Sophie Lite chairs with armrests, removable cover in fabric Antea 03 visone and structure in black elm. Symphony sideboards in gold oak with top in mat marble sahara noir polyester finish, handle and base with feet in mat brown nickel. Carpet Cannelé. This page: Henry table in black elm with top in glossy glass bordeaux. Next page: Henry table in gold walnut with top in mat marble calacatta oro.







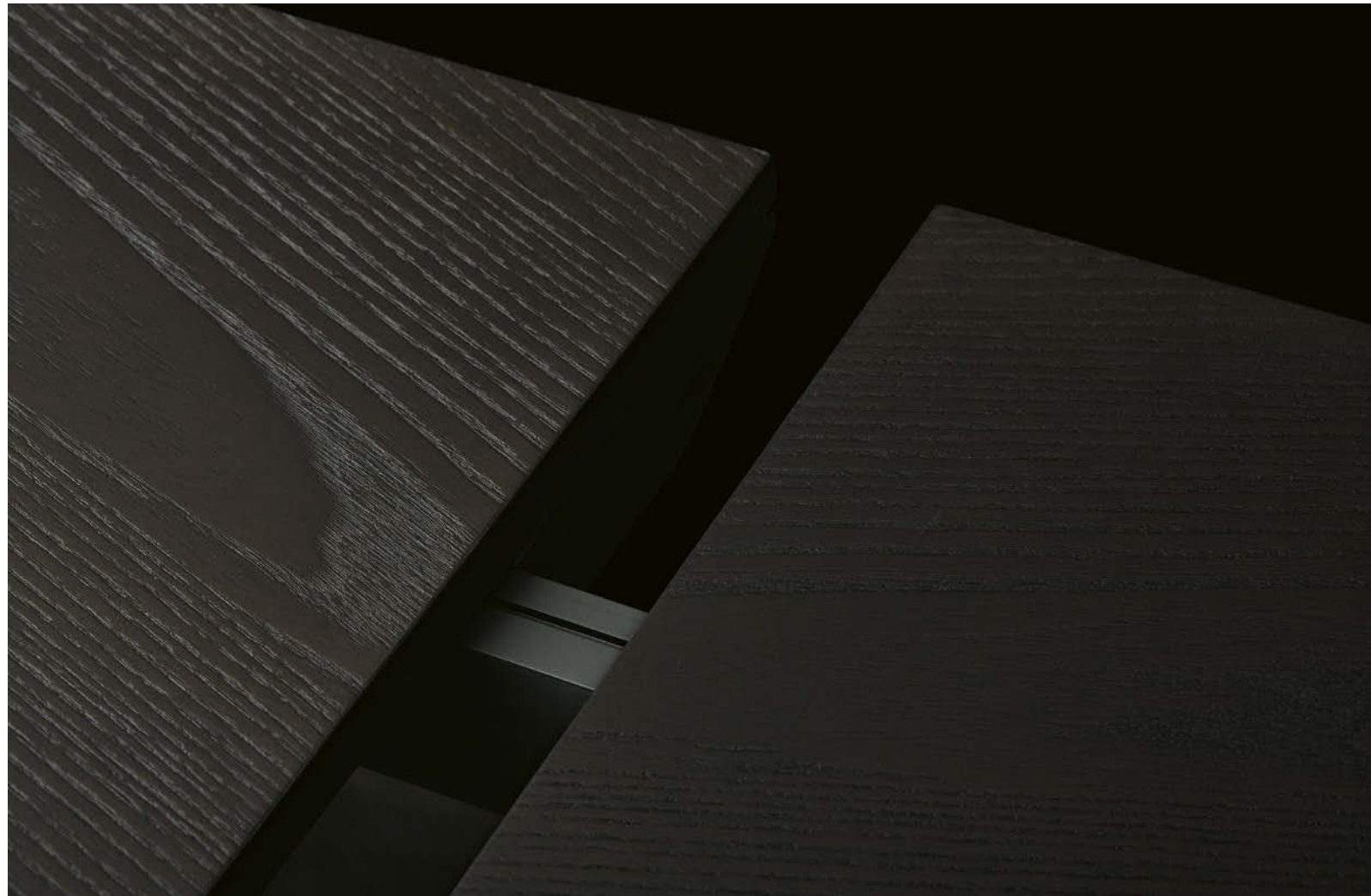

Qui e nella pagina successiva: tavolo Henry allungabile in olmo nero. Il piano in legno è caratterizzato dall'accostamento di lastre con venatura a spina di pesce.

This and next page: Henry extendable table in black elm. The veneer with herringbone grain distinguishes the top in wood.









## HENRY

Design Emmanuel Gallina, 2019

Tavolo fisso o allungabile. Struttura in massello, finitura olmo nero, rovere spessart o noce gold. Piano in olmo nero, rovere spessart, noce gold, marmo levigato e lucido (escluso zecevo) o vetro lucido nei colori ghiaccio, arena, grafite, bordeaux. Il piano nella versione legno è caratterizzato dall'accostamento di lastre con venatura a spina di pesce (escluso allunghe). La versione allungabile prevede solo il piano in olmo nero, rovere spessart o noce gold.

Fixed or extendable table. Solid wood structure, black elm, spessart oak or gold walnut finish. Top in black elm, spessart oak, gold walnut, mat and glossy marble (except zecevo) or glossy glass in the colours ghiaccio, arena, grafite, bordeaux. The top in the wooden version is characterized by the combination of veneers with herringbone grain (except extensions). The extendable version is available only with top in black elm, spessart oak or gold walnut.

### Piano in legno Wooden top

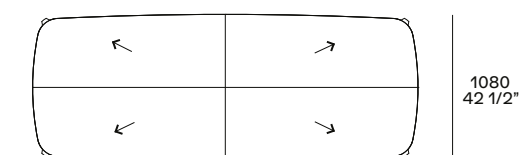
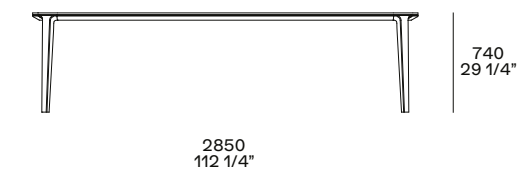
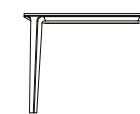
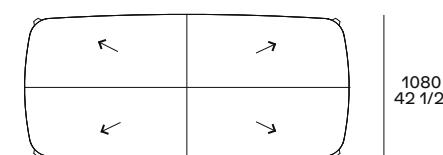
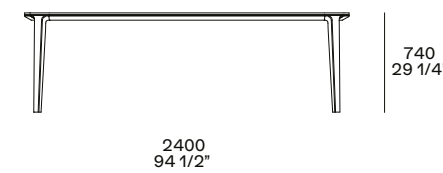
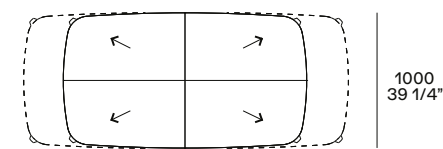
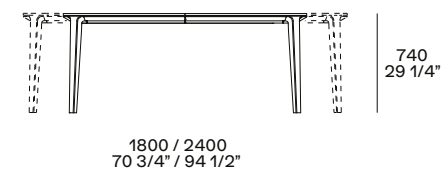

Le frecce indicano l'orientamento delle venature del legno.  
The arrows show the direction of the wooden grain.

### Piano in marmo e vetro Marble and glass top

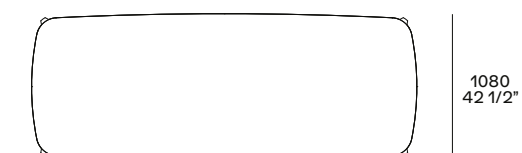
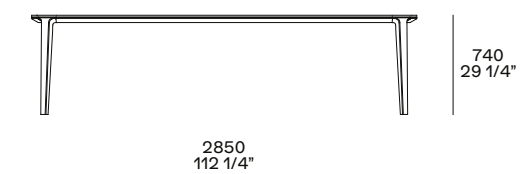
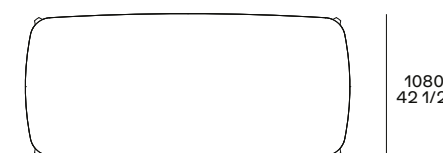
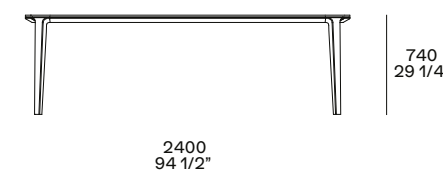



# CONCORDE



Essenziale eppure altero e importante, Concorde è un tavolo rettangolare, tondo o tondo con vassoio centrale girevole. La struttura è in legno, mentre il piano è disponibile in essenza, marmo o, nella versione rettangolare, anche in vetro con cornice in essenza.

Essential yet haughty and important, Concorde is a rectangular or round table, in the round version also available with a central rotating tray. The structure is in wood, while the top is available in wood, marble or, for the rectangular version, also in glass with wooden frame.









Nelle pagine precedenti: tavolo Concorde con struttura e cornice piano in olmo nero, piano in vetro lucido bordeaux. Sedie Sophie con e senza bracciolo, rivestimento non sfoderabile in pelle Soft 14 oliva, struttura in olmo nero. Panca Jane rivestimento sfoderabile in tessuto Orleans 12 carbone, struttura brown nickel lucido. In questa pagina: tavolo Concorde in olmo nero con piano in marmo grigio stardust lucido, inserti in brown nickel opaco e vassoio centrale girevole in olmo nero.

Previous pages: Concorde table with structure and top wooden frame in black elm, tabletop in glossy glass bordeaux. Sophie chairs with and without armrest, cover in non-removable leather Soft 14 oliva, and structure in black elm. Jane bench covered in removable fabric Orleans 12 carbone, structure in glossy brown nickel. This page: Concorde table in black elm with top in glossy marble grigio stardust, inlays in mat brown nickel and swivel tray in black elm.







Nella pagina precedente: tavolo Concorde con struttura in olmo nero e piano in marmo verde lepanto. In questa pagina: tavolo Concorde con struttura e piano in olmo nero con inserti in brown nickel opaco.

Previous page: Concorde table with structure in black elm and top in mat marble verde lepanto. This page: Concorde table with structure and top in black elm with inlays in mat brown nickel.



In questa pagina: tavolo Concorde in rovere spessart con piano in marmo calacatta oro levigato, inserti in brown nickel opaco e vassoio centrale girevole in rovere spessart. Sedie Grace con braccioli, rivestimento non sfoderabile in pelle Nabuk 05 grafite, struttura in rovere spessart.

This page: Concorde table in spessart oak with top in mat marble calacatta oro, inlays in mat brown nickel and swivel tray in spessart oak. Grace chairs with armrests cover in non-removable leather Nabuk 05 grafite, structure in spessart oak.









Qui e nella pagina precedente: tavolo Concorde con struttura in noce gold e piano in marmo calacatta oro levigato.

This and previous page: Concorde table in gold walnut with top in mat marble calacatta oro.





## CONCORDE

Design Emmanuel Gallina, 2009

Struttura in massello, finitura in noce gold, rovere spessart o olmo nero. Piano in noce gold, rovere spessart, olmo nero o marmo levigato e lucido (escluso zecevo). Piano Ø 1800 e 2000 con inserti in brown nickel opaco. Per le versioni rettangolari è disponibile anche il piano in vetro lucido nei colori ghiaccio, arena, grafite, bordeaux o in vetro riflettente blu con cornice in essenza. Per i tavoli Ø 1800 e 2000 è disponibile il vassoio girevole, opzionale in appoggio, in laccato opaco colori, noce gold, rovere spessart, olmo nero o marmo levigato e lucido (escluso zecevo).

Structure in solid wood finish in gold walnut, spessart oak or black elm. Top in gold walnut, spessart oak, black elm or mat and glossy marble (except zecevo). Top Ø 70 3/4" and 78 3/4" with inlays in mat brown nickel. For the rectangular versions, the tabletop is available also in glossy glass in the colours ghiaccio, arena, grafite, bordeaux or in blue reflecting glass with wooden frame. For the tables Ø 70 3/4" and 78 3/4" an optional spinning tray placed on the top is available, finishes mat lacquered colours, gold walnut, spessart oak, black elm or mat and glossy marble (except zecevo).

### Piano in essenza o marmo Wooden or marble top

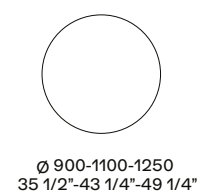
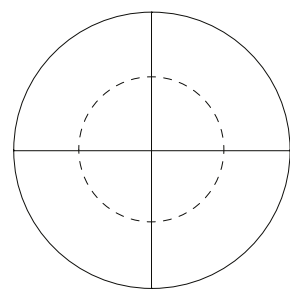
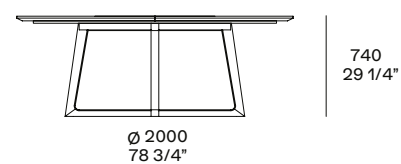
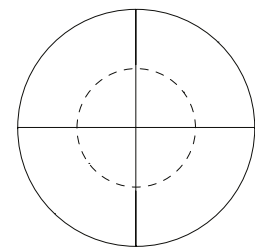
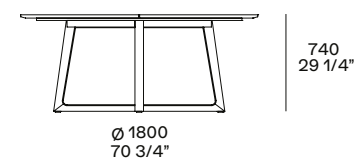
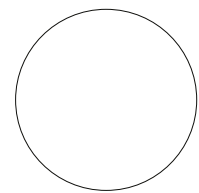
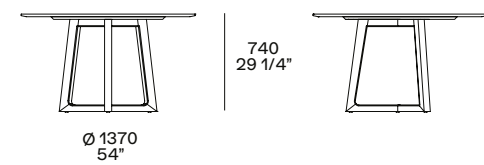

vassoio girevole opzionale  
optional swivel tray

### Piano in essenza o marmo Wooden or marble top

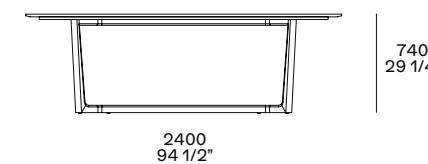
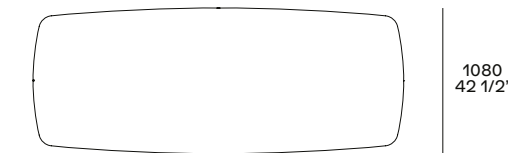
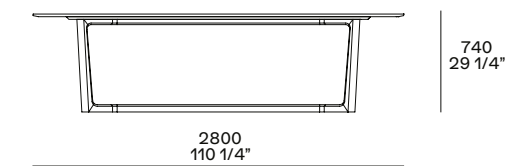
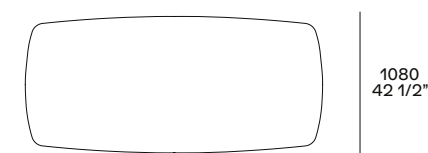
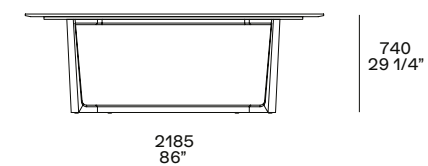

### Piano in vetro Glass top

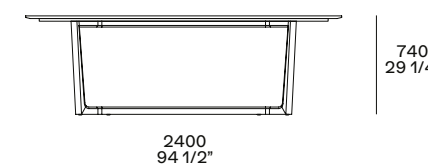
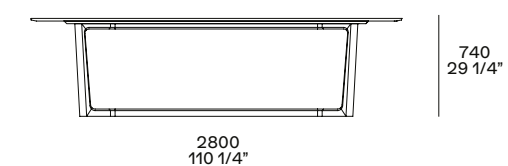
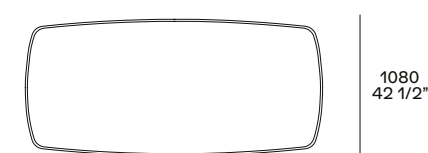
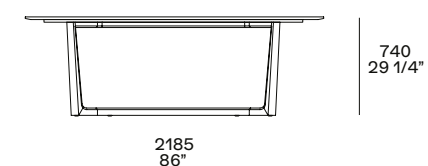



# KENSINGTON



Kensington è un tavolo-scultura disegnato da Jean-Marie Massaud. La struttura è caratterizzata dai moduli circolari, che sostengono un piano composto da elementi di forme e misure diverse. Rotondo o rettangolare, Kensington è un tavolo maestoso e suggestivo, un'opera d'arte per il living o l'ingresso.

Kensington is a sculpture-table designed by Jean-Marie Massaud. The structure is characterized by circular modules, which support a top composed of elements of different shapes and sizes. Round or rectangular, Kensington is a majestic and suggestive table, a work of art for the living or the hall.









Nelle pagine precedenti: tavolo Kensington con struttura in spatolato bronzo e piano in olmo nero. Sedie Stanford Bridge con rivestimento sfoderabile in tessuto Kitami 04 sabbia, basamento girevole in brown nickel lucido. Madia Home Hotel in olmo nero, ante e cassetti con frontali sagomati laccato opaco caramello e bordo in olmo nero. Pouf New York rivestimento sfoderabile in tessuto Agadir 01 sabbia e piedini brown nickel opaco. In questa pagina: tavolo Kensington con struttura spatolato ferro con piano in vetro fumé.

Previous pages: Kensington table with structure in bronzo with spatula finish and black elm top. Stanford Bridge chairs with removable cover in fabric Kitami 04 sabbia, glossy brown nickel swivel base. Home Hotel sideboard in black elm, doors and drawers with caramello mat lacquered shaped fronts and edge in black elm. New York pouf with removable cover in fabric Agadir 01 sabbia and mat brown nickel feet. This page: Kensington table with structure in ferro with spatula finish and top in fumé glass.









Nella pagina precedente: tavolo Kensington in metallo spatolato bronzo con piano in marmo calacatta oro lucido. In questa pagina: tavolo Kensington con struttura spatolato ferro con piano in olmo nero e vasoio centrale girevole in marmo noir saint laurent lucido.

Previous page: Kensington table in metal bronze with spatula finish and top in glossy marble calacatta oro. This page: Kensington table with structure in ferro with spatula finish with black elm top and swivel tray in glossy marble noir saint laurent.

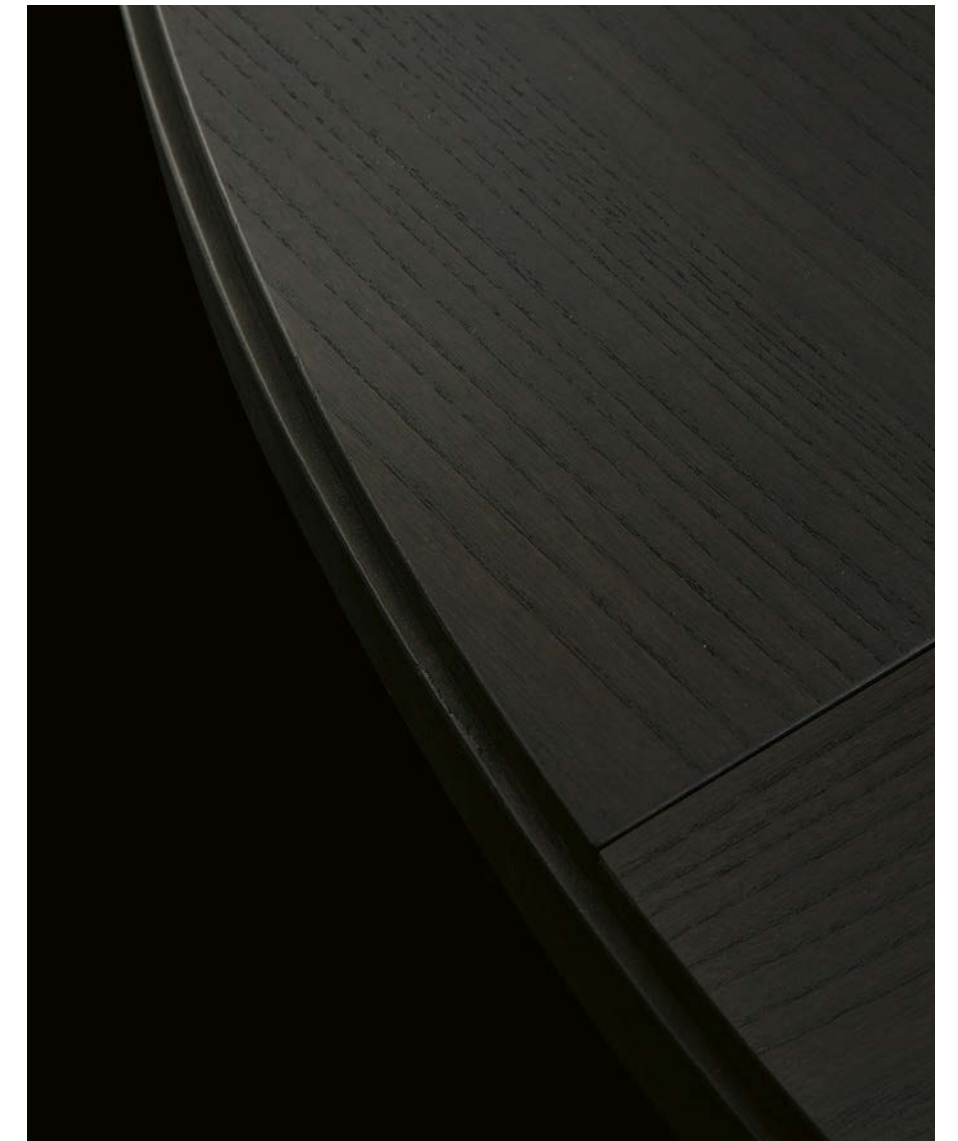

In questa pagina: tavolo Kensington con struttura spatolato ferro con piano in marmo lucido sahara noir finitura poliestere. Sedie Seattle con seduta e gambe rivestite in cuoio non sfoderabile 02 nero. Pouf Onda in tessuto non sfoderabile Sendai 03 fango. Madia Free in laccato lucido granata. Tappeto Plain tortora.

This page: Kensington table with structure in ferro with spatula finish and top in glossy marble sahara noir with polyester finish. Seattle chairs with seat and legs covered in non-removable hide 02 nero. Onda pouf in non-removable fabric Sendai 03 fango. Granata glossy lacquered Free sideboard. Carpet Plain tortora.







In questa pagina: tavolo Kensington con struttura spatolato bronzo con piano in olmo nero. Pouf Onda con rivestimento non sfoderabile in pelle Nabuk 09 ruggine. Armadio Senzafine Ocean con ante battenti in vetro acidato bronzo con profilo e maniglie Sydney a incasso in verniciato opaco ardesia. Tappeto Plain cipria.

This page: Kensington table with structure in metal bronzo with spatula finish and top in black elm. Onda pouf with non-removable cover in leather Nabuk 09 ruggine. Wardrobe Senzafine Ocean with leaf doors in etched glass bronzo with profile and built-in handles Sydney mat painted ardesia. Carpet Plain cipria.

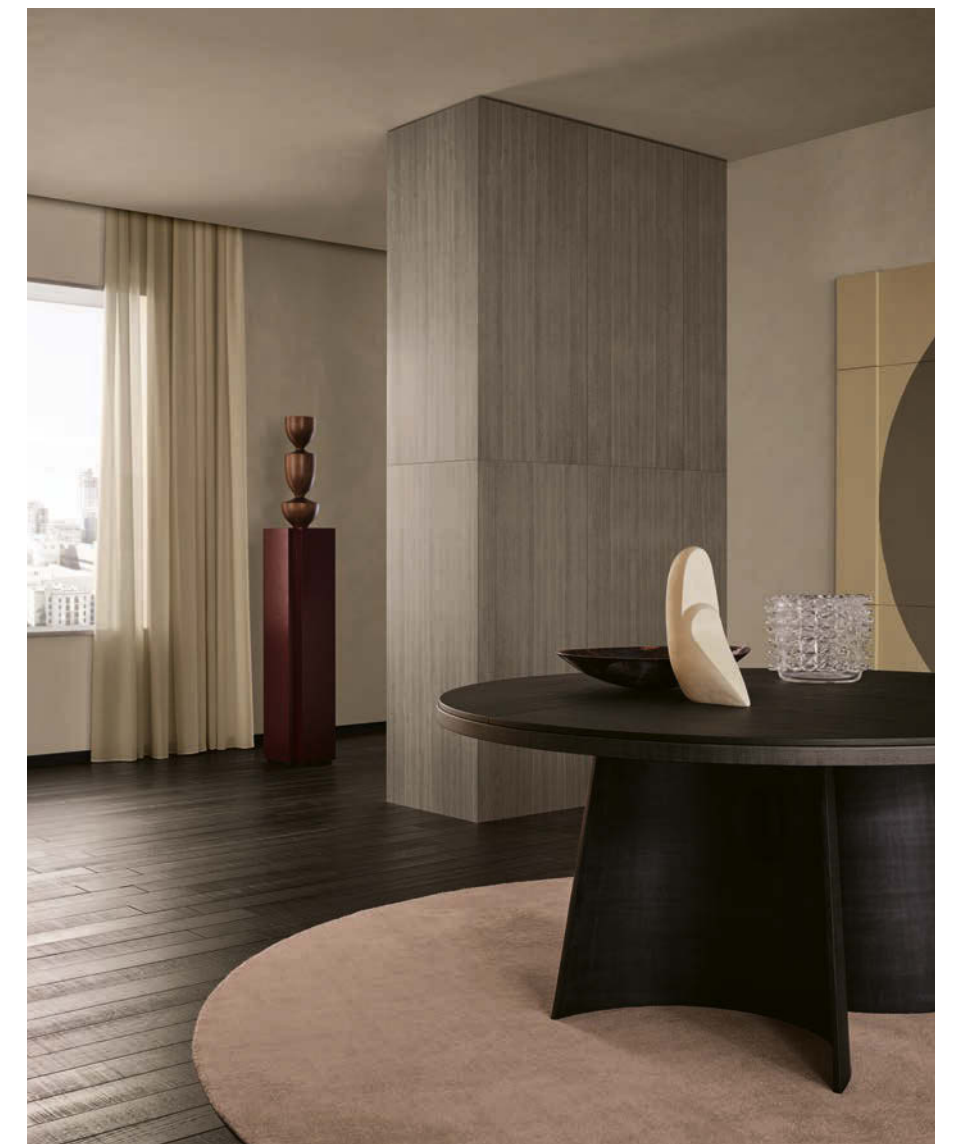

**KENSINGTON**  
Design Jean-Marie Massaud, 2018

Struttura in alluminio spatolato ferro e bronzo o laccato opaco champagne. Piano in olmo nero, vetro fumé o marmo levigato e lucido (escluso emperador dark e zecevo). Il piano in essenza e marmo è caratterizzato dall'accostamento di moduli di forme e misure diverse.  
Per i tavoli Ø 1600 e 2000 in essenza o marmo è disponibile il vassoio girevole, opzionale in appoggio, in laccato opaco colori, noce gold, rovere spessart, olmo nero o marmo levigato e lucido (escluso zecevo).

Structure in aluminium with spatula finish ferro and bronzo or champagne mat lacquered. Top in black elm, fumé glass or mat and glossy marble (except emperador dark and zecevo). The table top in wood and in marble is distinguished by the combination of modules of different shapes and sizes.  
For the tables Ø 63" and 78 3/4" in wood or marble an optional spinning tray placed on the top is available, finishes mat lacquered colours, gold walnut, spessart oak, black elm or mat and glossy marble (except zecevo).

**Piano in essenza o marmo**  
**Wooden or marble top**

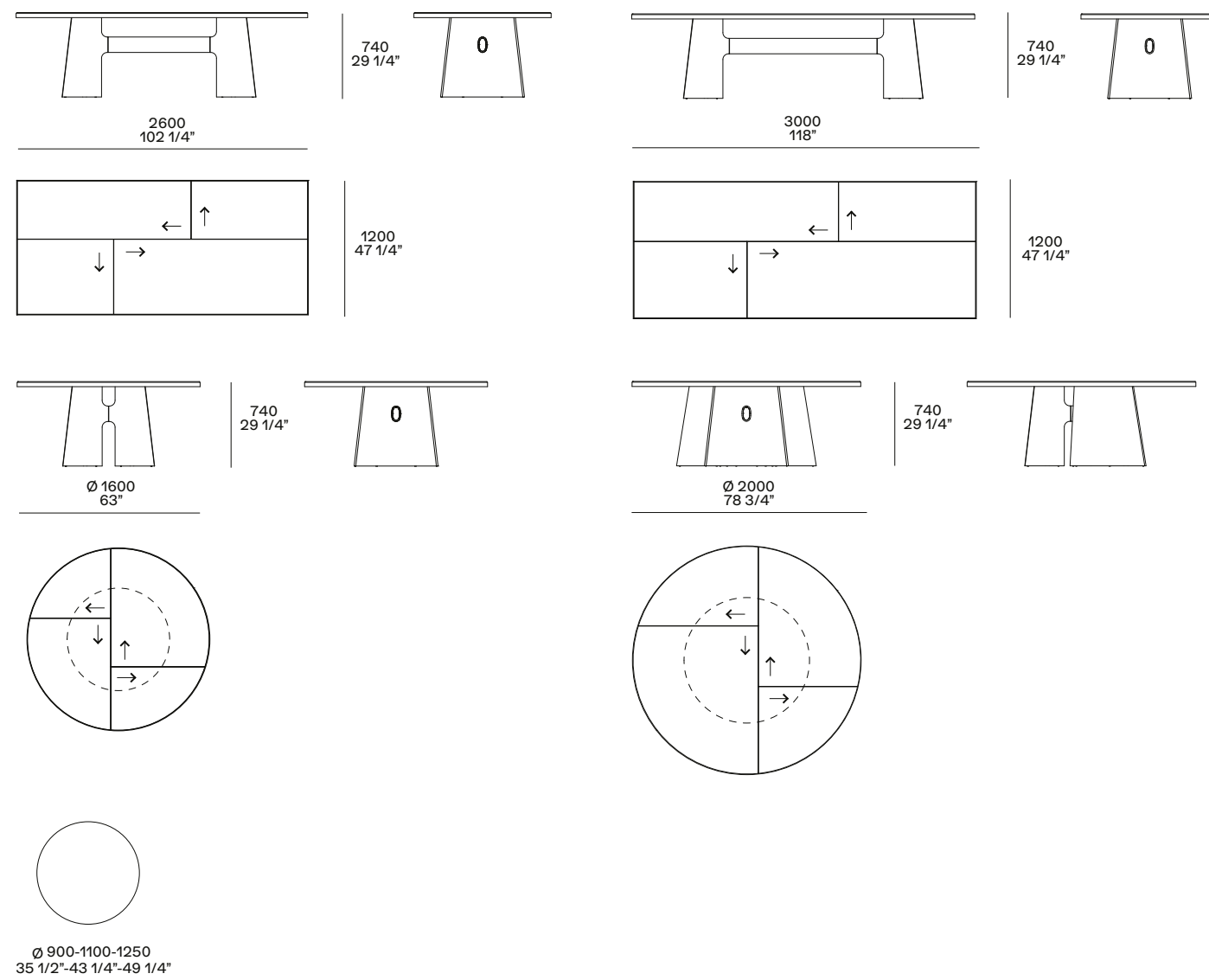

vassoio girevole opzionale  
optional swivel tray

Le frecce indicano l'orientamento delle venature del legno.  
The drawing shows the direction of the wooden grain.

**Piano in vetro**  
**Glass top**

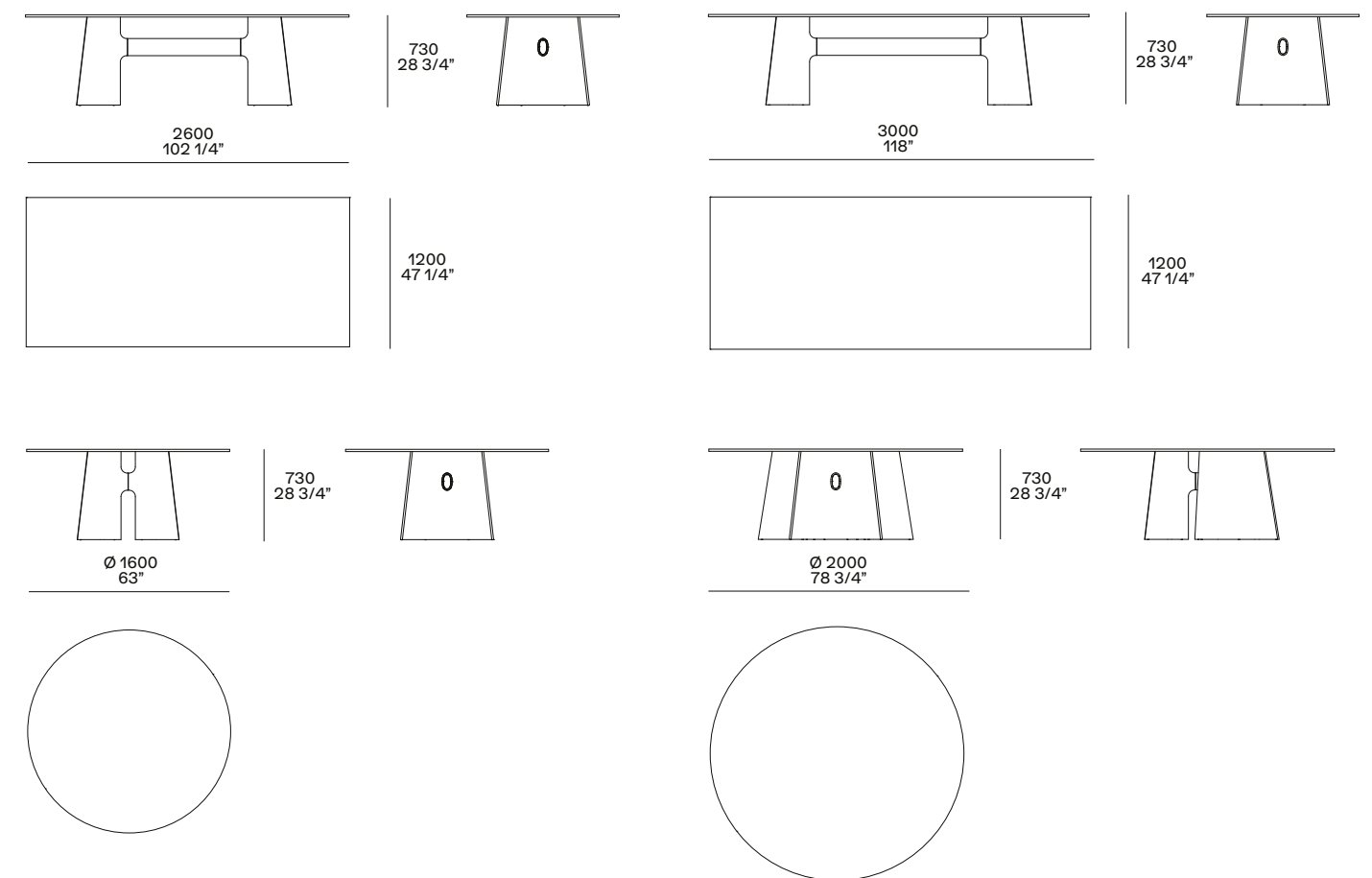





# HOME HOTEL

Protagonista della collezione Home Hotel di Jean-Marie Massaud, il tavolo è caratterizzato dal particolare disegno della base in legno e da una scelta accurata delle finiture. Nella versione rettangolare, il piano in marmo è integrato nello spessore del legno – una lavorazione di grande maestria. Il tavolo tondo è invece disponibile con piano in diverse finiture, anche con piano girevole integrato.

Protagonist of the Home Hotel collection by Jean-Marie Massaud, the dining table is distinguished by the particular design of the wooden base and by a careful choice of finishes. In the rectangular version, the marble top is integrated into the thickness of the wood - a work of great craftsmanship. The round table, on the other hand, is available with a top in different finishes, also with an integrated swivel top.









Nelle pagine precedenti: tavolo Home Hotel in olmo nero. Sedie Seattle con braccioli, seduta e gambe rivestite in cuoio non sfoderabile 29 tortora. Tappeto Frame perla. In questa pagina: tavolo Home Hotel con piano in marmo bianco carrara levigato, struttura e piano centrale girevole integrato in olmo nero. Nella pagina successiva: tavolo Home Hotel con piano in marmo sahara noir levigato e struttura in noce gold.

Previous pages: Home Hotel table in black elm. Seattle chairs with armrests, seat and legs covered in non-removable hide 29 tortora. Carpet Frame perla. This page: Home Hotel table with top in mat marble bianco carrara, structure and integrated swivel top in black elm. Next page: Home Hotel table with top in mat marble and gold walnut structure.





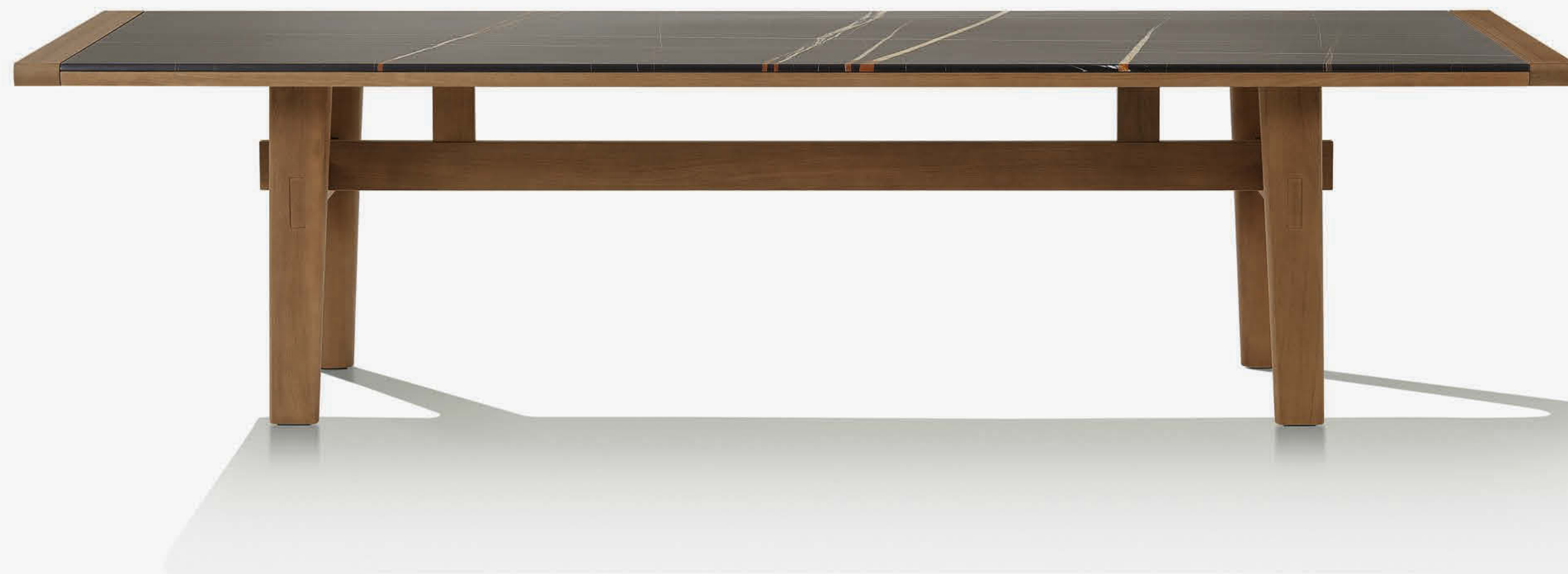



In questa pagina: tavolo Home Hotel in olmo nero con piano centrale girevole integrato in marmo noir saint laurent lucido. Nella pagina successiva: tavolo Home Hotel in olmo nero con piano centrale girevole integrato in marmo noir saint laurent lucido. Sedie Ipanema con braccioli, rivestimento non sfoderabile in pelle Soft 04 cognac, struttura in olmo nero. Tappeto Plain tortora.

This page: Home Hotel table in black elm with integrated swivel top in glossy marble noir saint laurent. Next page: Home Hotel table in black elm with integrated swivel top in glossy marble noir saint laurent. Ipanema chair with armrests, non-removable cover in leather Soft 04 cognac, structure in black elm. Carpet Plain tortora.

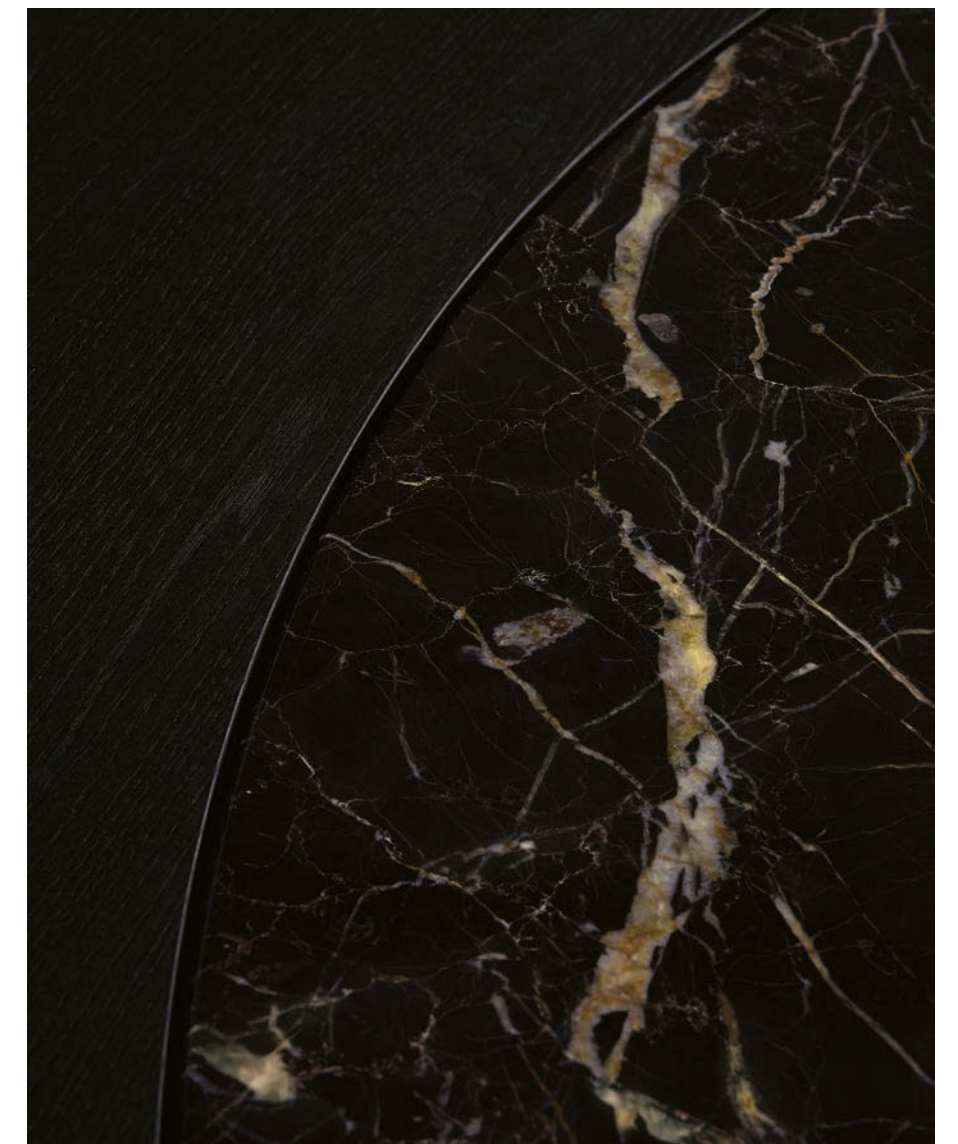











Qui e nella pagina precedente: tavoli Home Hotel con struttura e piano in olmo nero. Nella pagina successiva: tavolo Home Hotel in olmo nero con piano centrale girevole integrato in marmo noir saint laurent lucido.

This and previous page: Home Hotel tables with structure and top in black elm. Next page: Home Hotel table in black elm with integrated swivel top in glossy marble noir saint laurent.





## HOME HOTEL

Design Jean-Marie Massaud, 2016

Struttura in massello finitura olmo nero o massello noce gold. Piano in olmo nero o marmo levigato e lucido (escluso zecevo). Versione in noce gold disponibile solo con piano in marmo.

I tavoli ø 1800 e 2000 hanno un vassoio girevole integrato in olmo nero o marmo levigato e lucido (escluso zecevo). Per i tavoli ø 1800 e 2000 con piani in marmo il vassoio girevole è disponibile solo in olmo nero o noce gold.

Structure in solid wood finish black elm or solid gold walnut. Top in black elm or mat and glossy marble (except zecevo). Version in gold walnut available only with top in marble.

The tables ø 70 3/4" and 78 3/4" have an integrated swivel tray in black elm or mat and glossy marble (except zecevo). For tables ø 70 3/4" and 78 3/4" with marble top the swivel tray is available only in black elm or gold walnut.

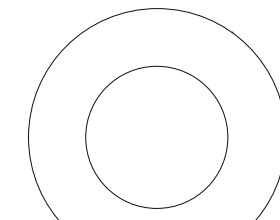
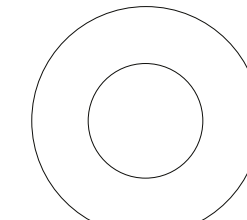
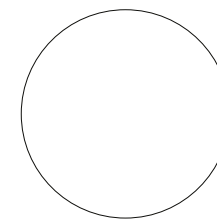
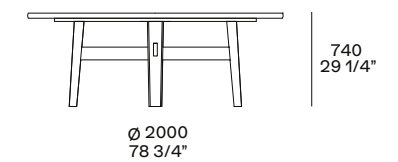
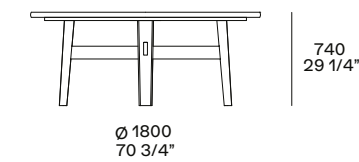
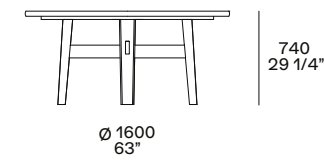
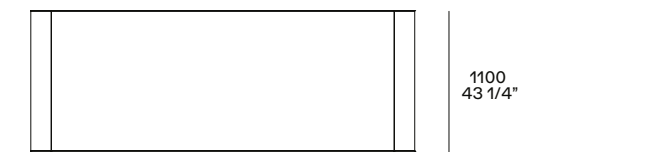
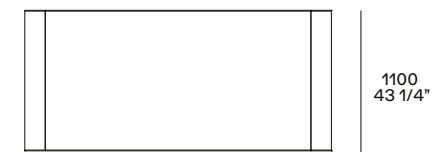
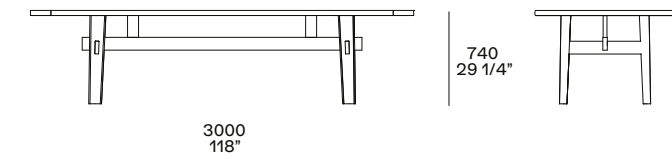
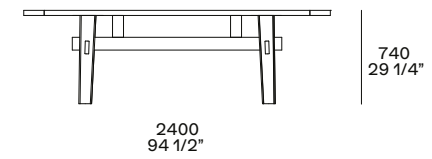





# FLUTE

Un tavolo dalle dimensioni contenute per le occasioni più intime. Roberto Barbieri reinterpreta una forma classica del design con personalità, unendo alla base sottile e pulita come quella di un calice il piano rotondo, da personalizzare con tutte le finiture disponibili, dai laccati opachi e lucidi al marmo.

A small table for the most intimate occasions. Roberto Barbieri reinterprets a classic shape of design with personality, combining the thin and clean base like that of a stem glass, with a round top, to be customized with all available finishes, from mat and glossy lacquers to marble.





Nella pagina precedente: tavolo Flute laccato opaco carbone con piano in marmo lucido sahara noir finitura poliester. Sedia Stanford Bridge senza braccioli, rivestimento non sfoderabile in pelle Soft 03 nocciola, basamento girevole in brown nickel opaco. Pouf Onda in veluto non sfoderabile Persia 1401 oliva. Tappeto Plain tortora. In questa pagina: tavolo Flute con struttura e piano in laccato lucido granata.

Previous page: carbone mat lacquered Flute table with top in glossy marble sahara noir with polyester finish. Stanford Bridge chair without armrests, non-removable cover in leather Soft 03 nocciola, swivel base in mat brown nickel. Onda pouf in non-removable velvet Persia 1401 oliva. Carpet Plain tortora. This page: Flute table with granata glossy lacquered structure and top.

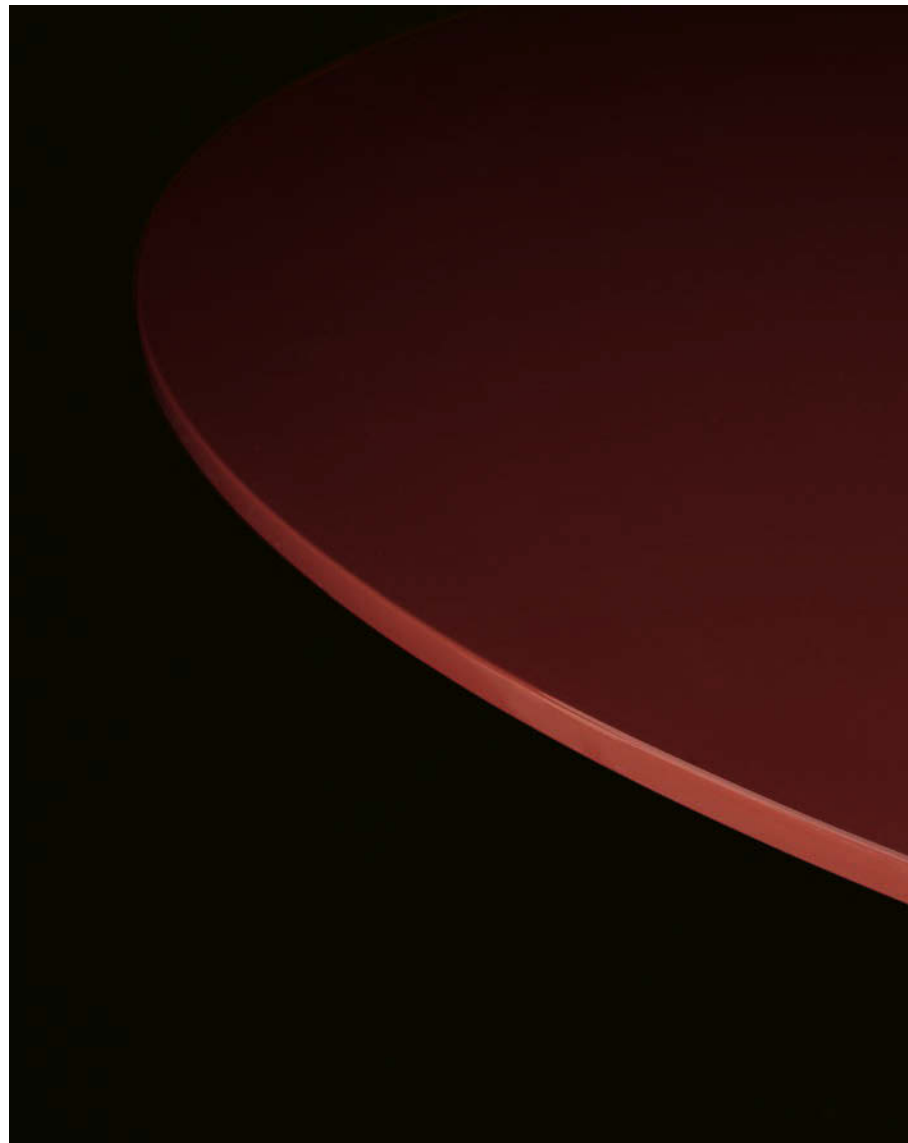



In questa pagina: tavolo Flute laccato opaco canapa con piano in marmo calacatta oro levigato. Nella pagina successiva: tavolo Flute laccato opaco carbone con piano in marmo lucido sahara noir finitura poliester. Sedia Stanford Bridge senza braccioli, rivestimento non sfoderabile in pelle Soft 03 nocciola, basamento girevole in brown nickel opaco. Pouf Onda in velluto non sfoderabile Persia 1401 oliva. Tappeto Plain tortora.

This page: canapa mat lacquered Flute table with top in mat marble calacatta oro. Next page: carbone mat lacquered Flute table with top in glossy marble sahara noir with polyester finish. Stanford Bridge chair without armrests, non-removable cover in leather Soft 03 nocciola, swivel base in mat brown nickel. Onda pouf in non-removable velvet Persia 1401 oliva. Carpet Plain tortora.

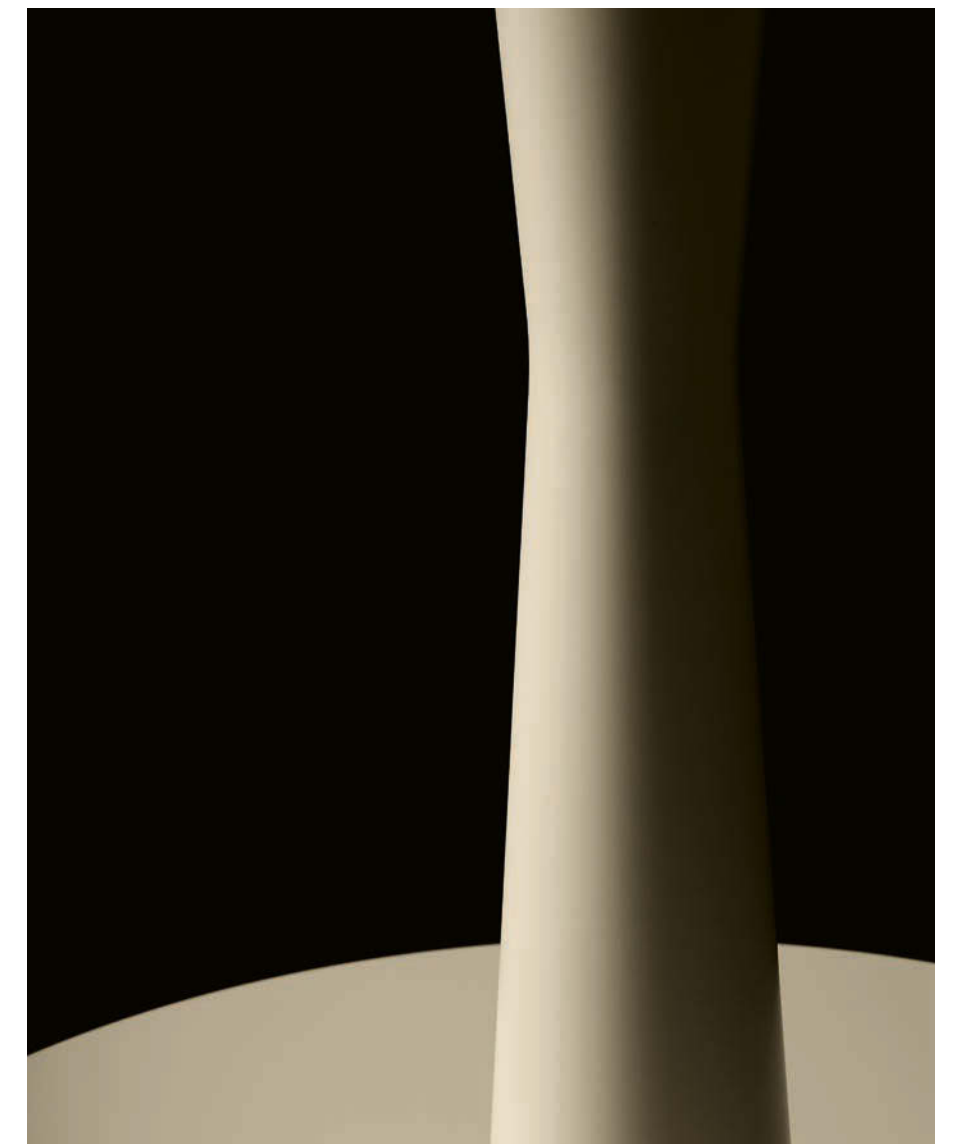





## FLUTE

Design Roberto Barbieri, 2008

Struttura in trafilato alluminio laccato opaco colori, laccato lucido colori, laccato antigraffio nei colori bianco, carbone, grafite, canapa o verniciato brown nickel opaco e lucido. Piano in laccato opaco colori, laccato lucido colori, laccato antigraffio nei colori bianco, carbone, grafite, canapa o marmo levigato e lucido (escluso zecevo).

Structure in extruded aluminium in the finishes mat lacquered colours, glossy lacquered colours, anti-scratch lacquer in the colours bianco, carbone, grafite, canapa or brown nickel mat and glossy. Top in the finishes mat lacquered colours, glossy lacquered colours, anti-scratch lacquer in the colours bianco, carbone, grafite, canapa or mat and glossy marble (except zecevo).

### Piano laccato Lacquered top

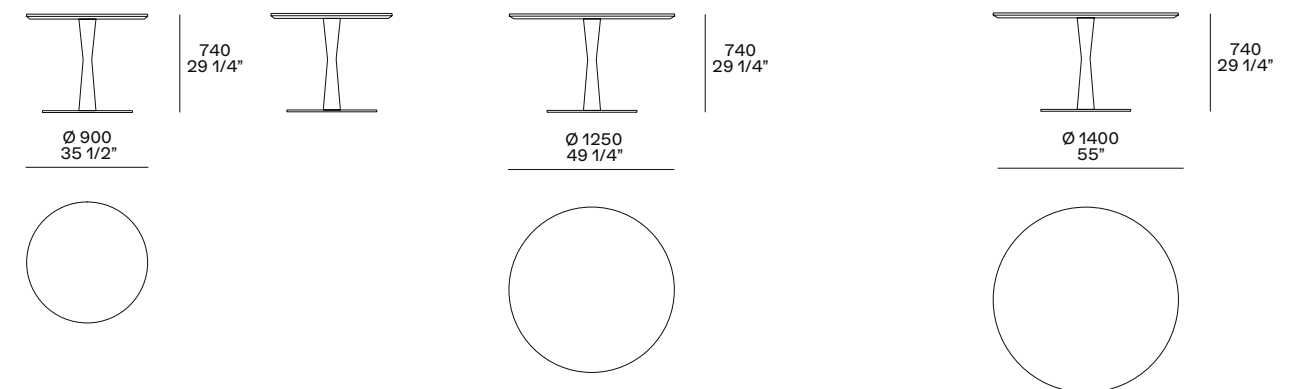

### Piano in marmo Top in marble

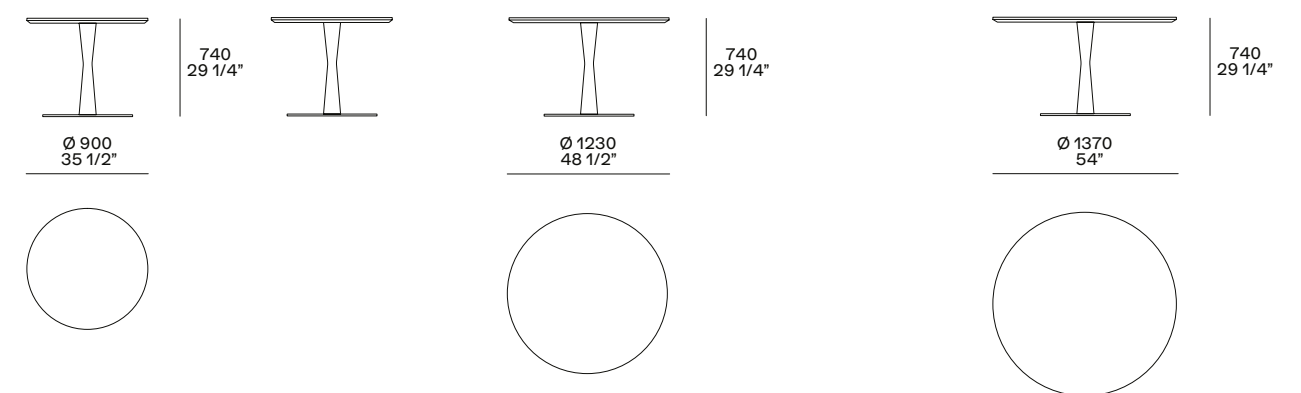



# HOWARD



Disegnato da Jean-Marie Massaud, Howard è un tavolo dallo stile essenziale. La struttura autoportante in metallo tagliato a laser e legno può sostenere un elegante piano in marmo o in essenza, più caldo e naturale.

Designed by Jean-Marie Massaud, Howard is a table with a minimalistic style. The self-supporting structure in laser-cut metal and wood can support an elegant top in marble or wood, warmer and more natural.

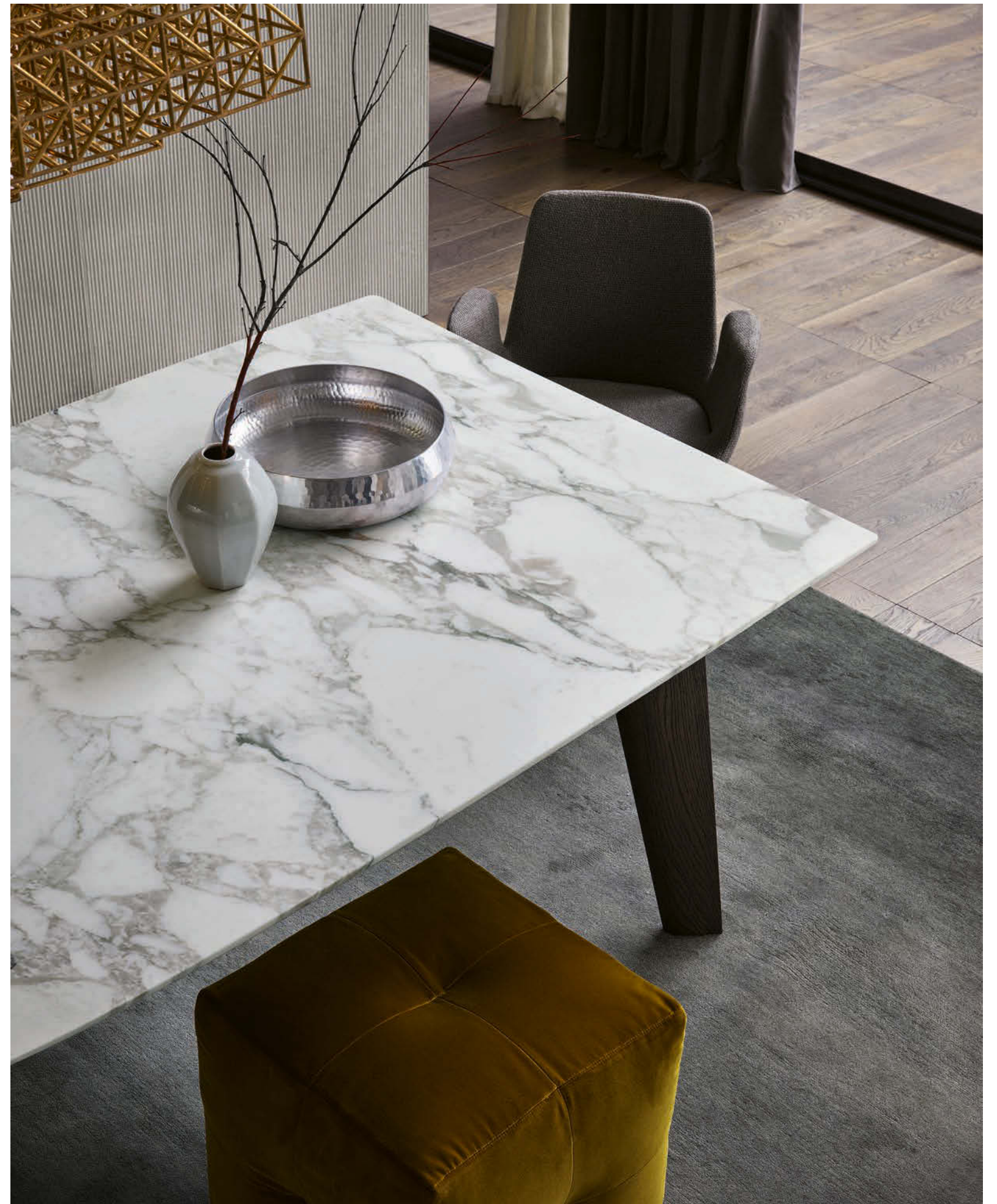







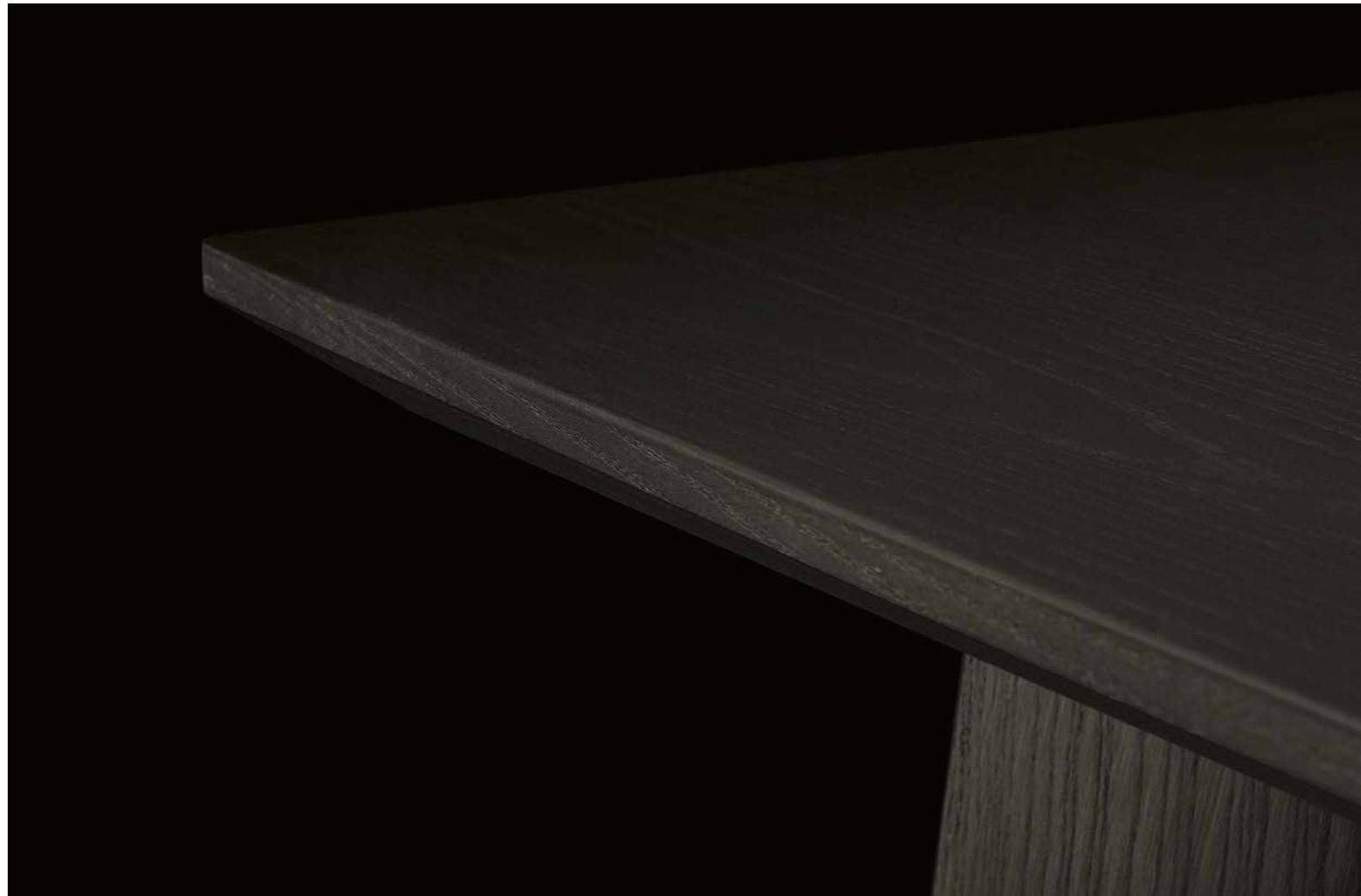

Nella pagina introduttiva: tavolo Howard in rovere spessart con piano in marmo noir saint laurent lucido. Nelle pagine precedenti: tavolo Howard in rovere spessart con piano in marmo calacatta oro levigato. Sedie Ventura con e senza braccioli, rivestimento non sfoderabile in tessuto Caleo 04 tortora, struttura in rovere spessart. Pouf Onda in velluto non sfoderabile Persia 1403 ocra. Tappeto Soft. Qui e nella pagina successiva: tavolo Howard in olmo nero. Nella pagina in chiusura: tavolo Howard in rovere spessart. Sedie Ventura con e senza braccioli, rivestimento non sfoderabile in tessuto Naxos 16 sabbia, struttura in rovere spessart.

Introduction page: Howard table in spessart oak with top in glossy marble noir saint laurent. Previous pages: Howard table in spessart oak with top in mat marble calacatta oro. Ventura chairs with or without armrests, cover in removable fabric Caleo 04 tortora, structure in spessart oak. Onda pouf in non-removable velvet Persia 1403 ocra. Carpet Soft. This and next page: Howard table in black elm. Closing page: Howard table in spessart oak. Ventura chairs with and without armrests, cover in non-removable fabric Naxos 16 sabbia, structure in spessart oak.









## HOWARD

Design Jean-Marie Massaud, 2011

Struttura in massello, finitura in rovere spessart o olmo nero. Telaio in metallo tagliato a laser e piegato, verniciato brown nickel opaco. Piano in rovere spessart, olmo nero o marmo levigato e lucido (escluso zecevo).

Structure in solid wood, finishes spessart oak or black elm. Frame in laser cut and folded metal painted mat brown nickel. Top in spessart oak, black elm or mat and glossy marble (except zecevo).

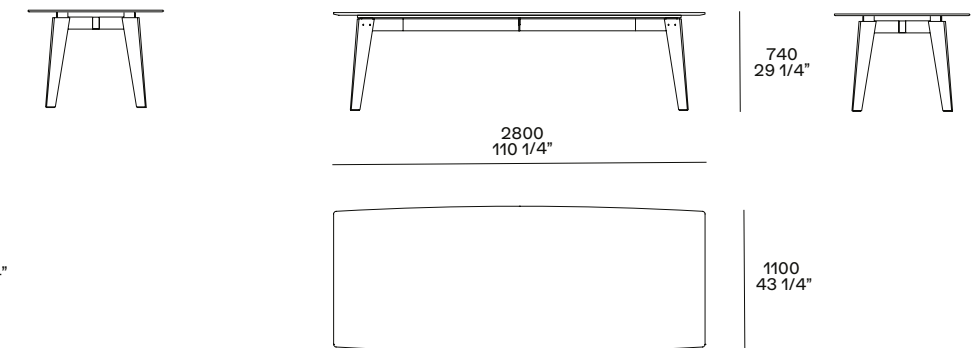
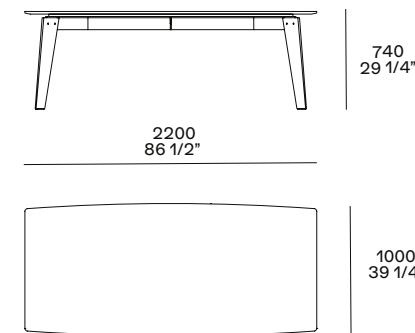



# BLADE



La semplicità della forma incontra il calore del legno nel tavolo da soggiorno per eccellenza, caratterizzato da linee essenziali e geometrie elementari. Quadrato o rettangolare, in quest'ultima versione Blade è personalizzabile al centimetro.

The simplicity of the shape meets the warmth of wood in the living room table par excellence, characterized by minimalistic lines and elementary geometry. Square or rectangular, in this latest version Blade is customizable down to the centimetre.









Nelle pagine precedenti e in chiusura: tavolo Blade con struttura e piano in massello noce canaletto. Sedie Seattle con e senza braccioli, seduta e gambe rivestite in cuoio non sfoderabile 26 invecchiato. Cucina Alea Pro, isola centrale con estrattori, ante, fianchi di finitura e top in Inalco MDi® stone brown, profilo maniglia, sagoma e distanziali in anodizzato moka, piano snack Sydney in massello di noce canaletto. Colonne con ante ed estrattori in acciaio PVD bronzo con distanziali in anodizzato moka. Colonne con ante vetrina PR24 in anodizzato moka e vetro riflettente fumé, con struttura interna in noce canaletto naturale, illuminazione a led integrata. Qui e nella pagina successiva: tavolo Blade con struttura e piano in massello tinto olmo nero.

Previous pages and closing page: Blade table with structure and top in solid walnut canaletto. Seattle chairs with and without armrests, seat and legs covered in non-removable hide 26 invecchiato. Alea Pro kitchen, central island with pull-out baskets, doors, finishing sides and worktop in Inalco MDi® stone brown, handle profile, profile and spacers anodized moka, Sydney snack worktop in solid walnut canaletto. Tall units with doors and pull-out baskets in PVD steel bronzo with anodized moka spacers. Tall units with glass doors PR24 anodized moka and fumé reflecting glass, with inner structure in natural walnut canaletto, integrated led light. This and next page: Blade table with structure and top in solid wood stained black elm.









## BLADE

Design R&D Poliform, 2014

Struttura e piano in massello di noce canaletto o massello tinto olmo nero. Nella versione rettangolare la lunghezza del tavolo si può personalizzare al centimetro.

Structure and top in solid wood walnut Canaletto or in solid wood stained black elm. In the rectangular version, the table length is customizable to the centimeter.

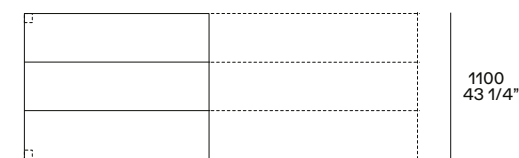
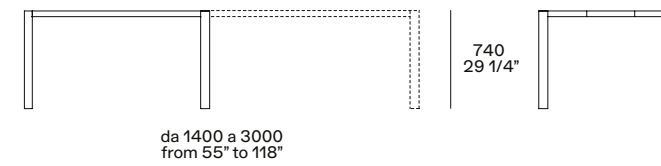
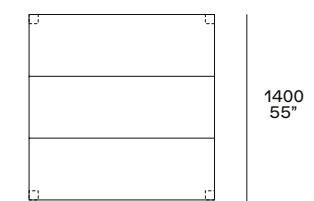
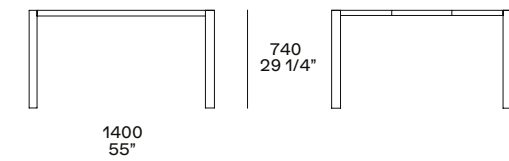
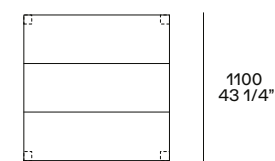
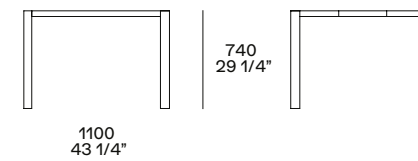

# TREVI



Per il suo design essenziale fatto di geometrie e di spessori effimeri, Trevi è un tavolo che si può adattare a diversi ambienti della casa. Disponibile in versione quadrata o rettangolare, ha il piano e le gambe in finitura laccata opaca, anche in versione antigraffio.

Because of its minimalistic design made of ephemeral geometry and thicknesses, Trevi is a table that can adapt to several environments of the house. Available in square or rectangular version, it has the top and legs in mat lacquered finish, also in an anti-scratch version.









## TREVI

Design Roberto Barbieri, 2005

Struttura in trafilato alluminio laccato opaco colori, laccato antigraffio nei colori bianco, carbone, grafite, canapa o verniciato brown nickel opaco e lucido. Piano in laccato opaco colori o laccato antigraffio nei colori bianco, carbone, grafite e canapa.

Structure in extruded aluminium in the finishes mat lacquered colours, anti-scratch lacquer in the colours bianco, carbone, grafite, canapa or brown nickel mat and glossy. Top in the finishes mat lacquered colours or anti-scratch lacquer in the colours bianco, carbone, grafite, canapa.

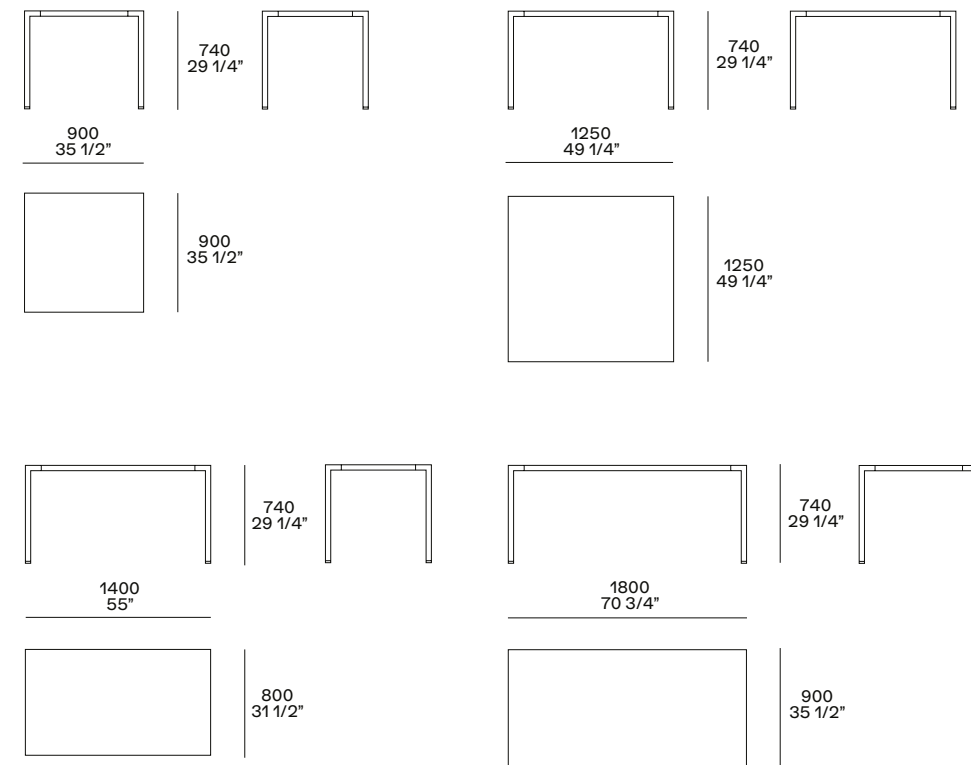

Nella pagina precedente: tavolo Trevi in brown nickel opaco con piano in laccato opaco carbone. In questa pagina: tavolo Trevi con struttura e piano in laccato opaco bianco.

Previous page: Trevi table in mat brown nickel with carbone mat lacquered top. This page: Trevi table with bianco mat lacquered structure and top.

# DESKS



Classico protagonista di ambienti dedicati allo studio e al lavoro, complemento indispensabile di librerie e biblioteche, lo scrittoio è oggi un elemento colto e attuale nella zona giorno, discreto e intimo nella zona notte. Emmanuel Gallina e Jean-Marie Massaud lo reinterpretano con la consueta raffinatezza, tra estetica e funzionalità, con materiali di pregio e dettagli esclusivi come i piani sottomano opzionali in cuoio e i piccoli cassetti. Perfeziona la collezione Mathieu, scrittoio-toeiletta che per le sue linee delicate è l'ideale completamento delle zone notte più contemporanee.

Classic protagonist of environments dedicated to study and work, an indispensable complement of bookstores and libraries, the writing desk is now a cultured and current element in the day area, discreet and intimate in the night area. Emmanuel Gallina and Jean-Marie Massaud reinterpret it with the usual refinement, between look and functionality, with prestigious materials and exclusive details such as the optional desk pads in hide and small drawers. To perfect the collection there is Mathieu, writing desk that with its delicate lines is the ideal closing touch to the most contemporary night areas.

## DESKS

CONCORDE	323
MATHIEU	331
HOME HOTEL	339
HOME HOTEL CONSOLE	344

# CONCORDE



Emmanuel Gallina ridisegna le forme leggere ed essenziali del tavolo Concorde realizzando lo scrittoio ideale per lo studio di casa con un'accurata scelta dei materiali. Concorde è disponibile con o senza cassetto e piano sottomano in cuoio.

Emmanuel Gallina redesigns the light and minimalistic shapes of the Concorde table, creating the ideal writing desk for the house study with an accurate choice of materials. Concorde is available with or without drawer and desk pad in hide.



Nella pagina precedente: scrittoio Concorde in rovere spessart con sottomano in cuoio 02 nero. Sedia Manta con braccioli, rivestimento non sfoderabile in pelle Silk 08 nero. Pouf Onda in velluto non sfoderabile Persia 1401 oliva. Boiserie Dream velluto Persia 1404 carbone con mensole laccato lucido visone. In questa pagina: scrittoio Concorde in olmo nero con sottomano in cuoio 38 oliva e cassetto sottopiano in laccato opaco carbone.

Previous page: Concorde in spessart oak with desk pad in hide 02 nero. Manta chair with armrests, cover in non-removable leather Silk 08 nero. Onda pouf in non-removable velvet Persia 1401 oliva. Dream wall panelling in velvet Persia 1404 carbone with visone glossy lacquered shelves. This page: Concorde writing desk in black elm with desk pad in hide 38 oliva and undermount drawer in mat lacquered carbone.

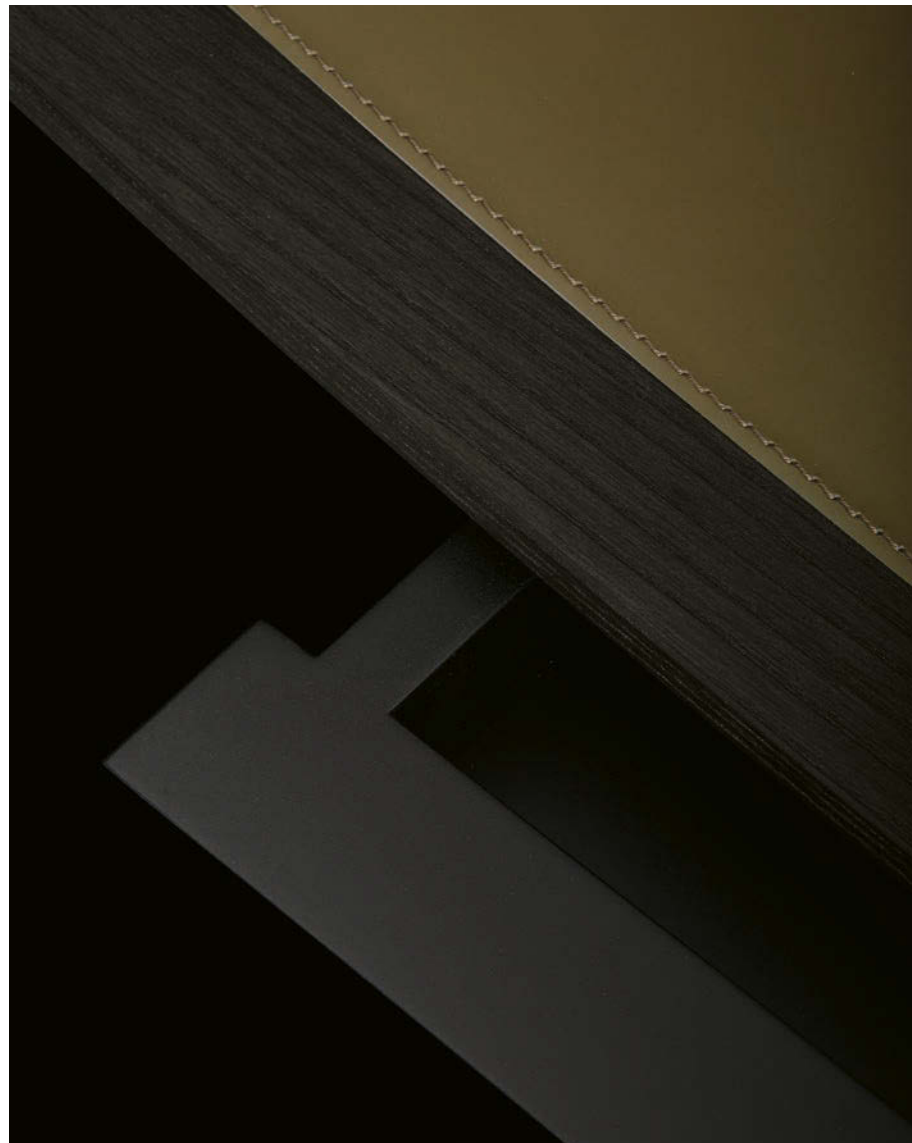





## CONCORDE

Design Emmanuel Gallina, 2009

Struttura in massello finitura noce gold, rovere spessart o olmo nero.  
Piano in noce gold, rovere spessart o olmo nero. Il piano è disponibile anche con sottomano in cuoio colori. È previsto un cassetto sottopiano opzionale in laccato opaco carbone.

Structure in solid wood in the finishes gold walnut, spessart oak or black elm.  
Top in gold walnut, spessart oak or black elm. The top is available also with desk pad in hide in the available colours.  
An optional undermount drawer in mat lacquer carbone is available.

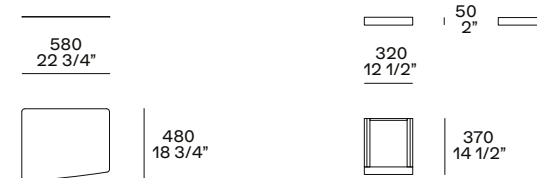
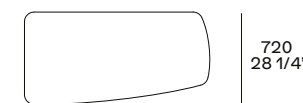
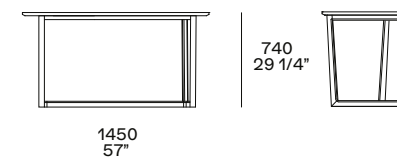

sottomano in cuoio opzionale  
optional desk pad in hide

cassetto sottopiano opzionale  
optional undermount drawer

# MATHIEU



Mathieu è uno scrittoio dalla silhouette slanciata e dai profili delicati. Il piano, con cornice in essenza e inserto in cuoio, disegna curve delicate che addolciscono le linee decise della struttura, in metallo verniciato. Eleganti e discreti gli accessori opzionali: il piccolo cassetto sottopiano e lo specchio.

Mathieu is a writing desk with a slender and delicate profile. The top, with wooden frame and leather insert, draws delicate curves that soften the precise lines of the structure, in painted metal. Elegant and discreet are the optional accessories: the small under mount drawer and the mirror.



Nella pagina precedente e nella successiva: scrittoio Mathieu con struttura brown nickel lucido, piano con cornice rovere spessart e inserto in cuoio 29 tortora. Cassetto sottopiano in laccato opaco carbone e specchio con struttura brown nickel lucido. Sedia Guest con rivestimento non sfoderabile in pelle Soft 10 prugna, cuscino seduta sfoderabile nella stessa finitura. In questa pagina: scrittoio Mathieu con struttura brown nickel lucido, piano con cornice olmo nero e inserto in cuoio 02 nero. Cassetto sottopiano in laccato opaco carbone.

Previous and next page: Mathieu writing desk with glossy brown nickel structure, top with frame in spessart oak and inlay in hide 29 tortora. Carbone mat lacquered undermount drawer and mirror with glossy brown nickel support. Guest chair with non-removable cover in leather Soft 10 prugna, seat cushion with removable cover in the same material. This page: Mathieu writing desk with glossy brown nickel structure, top with black elm frame and inlay in hide 02 nero. Carbone mat lacquered undermount drawer.







## MATHIEU

Design Emmanuel Gallina, 2017

Struttura in metallo verniciato brown nickel opaco o lucido. Piano con cornice in rovere spessart o olmo nero con inserto in cuoio nei colori 19 caffè, 02 nero, 03 grigio scuro e 29 tortora. Il piano è disponibile anche con specchio in metallo verniciato brown nickel opaco o lucido. È previsto un cassetto sottopiano opzionale in laccato opaco carbone.

Structure in painted metal mat or glossy brown nickel. Top with frame in spessart oak or black elm with inlay in hide in the colours 19 caffè, 02 nero, 03 grigio and 29 tortora. The top is available also with mirror in mat or glossy brown nickel painted metal. An optional undermount drawer in mat lacquer carbone is available.

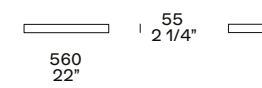
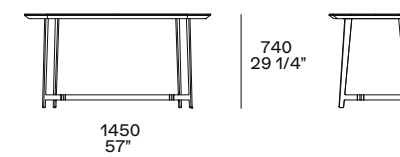

cassetto sottopiano opzionale  
optional undermount drawer

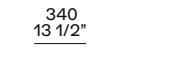

specchio opzionale  
optional mirror

# HOME HOTEL



Eleganza e versatilità sono il fil rouge della collezione con cui Jean-Marie Massaud reinterpreta gli spazi dell'abitare contemporaneo. Nelle sue due declinazioni, Home Hotel è uno scrittoio solido e leggero oppure una consolle. Lo scrittoio, in olmo nero, è disponibile con o senza cassetto e piano sotto-mano in cuoio.

Elegance and versatility are the common thread of the collection with which Jean-Marie Massaud reinterprets the space of contemporary living. In its two versions, Home Hotel is at the same time a solid and light writing desk or a console table. The desk, in black elm, is available with or without drawer and desk pad in hide.



Qui e nella pagina precedente: scrittoio Home Hotel con struttura, piano e cassetto sottopiano in olmo nero, sottomano in cuoio 02 nero. Sedia Sophie con braccioli, rivestimento non sfoderabile in pelle Soft 02 mastice, struttura in olmo nero.

This and previous page: Home Hotel writing desk with structure, top and undermount drawer in black elm, desk pad in hide 02 nero. Sophie chair with armrests, cover in non-removable leather Soft 02 mastice, structure in black elm.







In questa pagina: consolle Home Hotel con struttura e piano in olmo nero, in appoggio sul piano contenitore Vanity in laccato opaco vischio.

This page: Home Hotel console with structure and top in black elm, vischio mat lacquered Vanity storage unit leant on the top.



In questa pagina: contenitore Vanity in laccato opaco vischio, griglia interna in olmo nero, fondo in tecnocover Grain 05 latte e specchio interno. Nella pagina successiva: consolle Home Hotel con struttura e piano in olmo nero. Divano Bristol rivestimento sfoderabile in tessuto Kitami 02 cenere.

This page: vischio mat lacquered Vanity storage unit, inner partition in black elm, bottom in tecnocover Grain 05 latte and inner mirror. Next page: Home Hotel with structure and top in black elm. Bristol sofa with removable cover in fabric Kitami 02 cenere.





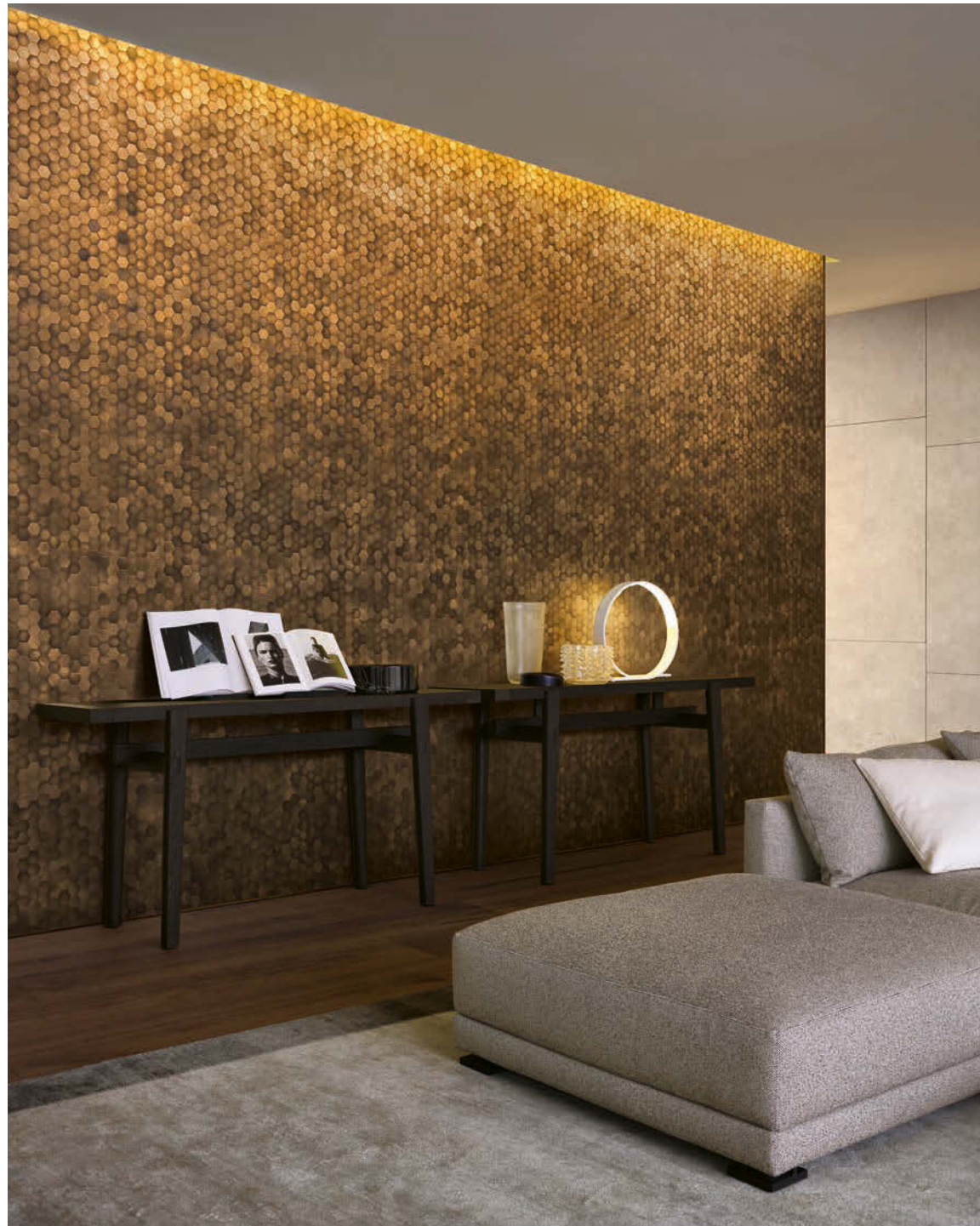

## HOME HOTEL

Design Jean-Marie Massaud, 2016

Scrivania con struttura in massello finitura olmo nero. Piano in olmo nero. Il piano è disponibile anche con sottomano in cuoio opzionale in olmo nero.

Consolle con struttura in massello finitura olmo nero. Piano in olmo nero.

Contenitore Vanity, opzionale in appoggio al piano, in laccato opaco colori con griglia interna in olmo nero, fondo in tecnocover Grain e specchio interno.

Writing desk with structure in solid wood in black elm finish. Top in black elm.

The top is available also with desk pad in hide in the available colours. An optional undermount drawer in black elm is available.

Console with structure in solid wood with black elm finish. Top in black elm.

Optional Vanity storage unit leant on top in mat lacquered colours with inner partition in black elm, bottom in tecnocover Grain and inner mirror.

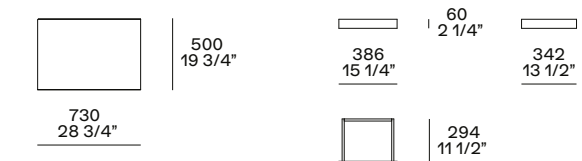
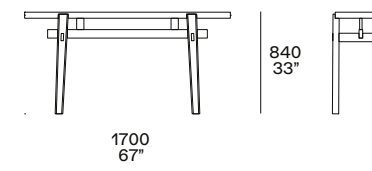
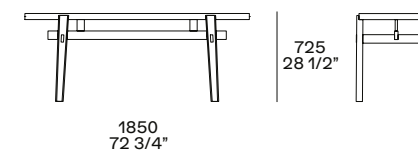

sottomano in cuoio opzionale  
optional desk pad in hide



cassetto sottopiano opzionale  
optional undermount drawer

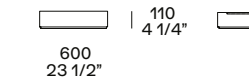

contenitore Vanity opzionale  
optional storage unit Vanity

# SIDEBOARDS



Espositori e contenitori allo stesso tempo, le madie sono complementi immancabili nella zona giorno. Dall'elemento più semplice al sistema complesso, dallo stile classico a quello contemporaneo, sempre con un occhio di riguardo ai materiali, la collezione di madie di Poliform è molto variegata, grazie alle proposte dei designer Jean-Marie Massaud, Emmanuel Gallina e Carlo Colombo.

Display and storage units at the same time, sideboards are essential additions to the day area. From the simplest element to the complex system, from the classic style to the contemporary one, always with a special attention to materials, Poliform's collection of sideboards is very varied, thanks to the offers by the designers Jean-Marie Massaud, Emmanuel Gallina and Carlo Colombo.

## SIDEBOARDS

SYMPHONY	355
CODE	385
FREE	423
PANDORA	437
BRISTOL SYSTEM	451
BRISTOL SYSTEM BOOKCASE	464

# SYMPHONY



Symphony è una collezione di madie dove l'essenzialità delle linee si esprime attraverso materiali pregiati e lavorazioni accurate. Disegnate da Emmanuel Gallina, le madie sono caratterizzate da una forma ellittica, valorizzata dalla finitura legno che ne segue morbidamente le curve. La collezione include elementi di altezze e misure diverse – dalle versioni alta e media con ante alla versione bassa con cassetti o con cassetto e vano a giorno, tutte su basamento con piedini.

Symphony is a collection of sideboards, where the essentiality of the lines is expressed through precious materials and accurate workmanship. Designed by Emmanuel Gallina, the sideboards feature an elliptical shape, enhanced by the wood finish that softly follows the curves. The collection includes elements of different heights and sizes – from the high and medium version with doors, to the low version with drawers or with drawer and open compartment, all on a base with feet.











Qui e nelle pagine precedenti: madie Symphony in rovere gold con top in marmo levigato sahara noir finitura poliestere, basamento con piedini e maniglia in brown nickel opaco. Tavolo Henry con piano in marmo levigato sahara noir finitura poliestere e struttura in olmo nero. Sedie Sophie Lite con braccioli, rivestimento sfoderabile in tessuto Antea 03 visone e struttura in olmo nero. Tappeto Cannelé. Sotto: struttura interna in rovere gold, cassettera con fondo rivestito in tecnocover Grain 06 nocciola, attrezzata con portaposate in massello tinto rovere gold e fondo in tecnocover Grain 06 nocciola, ripiano in vetro fumé, luce a led integrata con sensore.

This and previous pages: Symphony sideboards in gold oak with top in mat marble sahara noir polyester finish, base with feet and handle in mat brown nickel. Henry table with top in mat marble sahara noir polyester finish and structure in black elm. Sophie Lite chairs with armrests with removable cover in fabric Antea 03 visone and structure in black elm. Carpet Cannelé. Below: inner structure in gold oak, chest of drawers with bottom in tecnocover Grain 06 nocciola, accessorized with cutlery tray in solid wood stained gold oak and bottom in tecnocover Grain 06 nocciola, shelf in glass fumé, integrated led light with sensor.

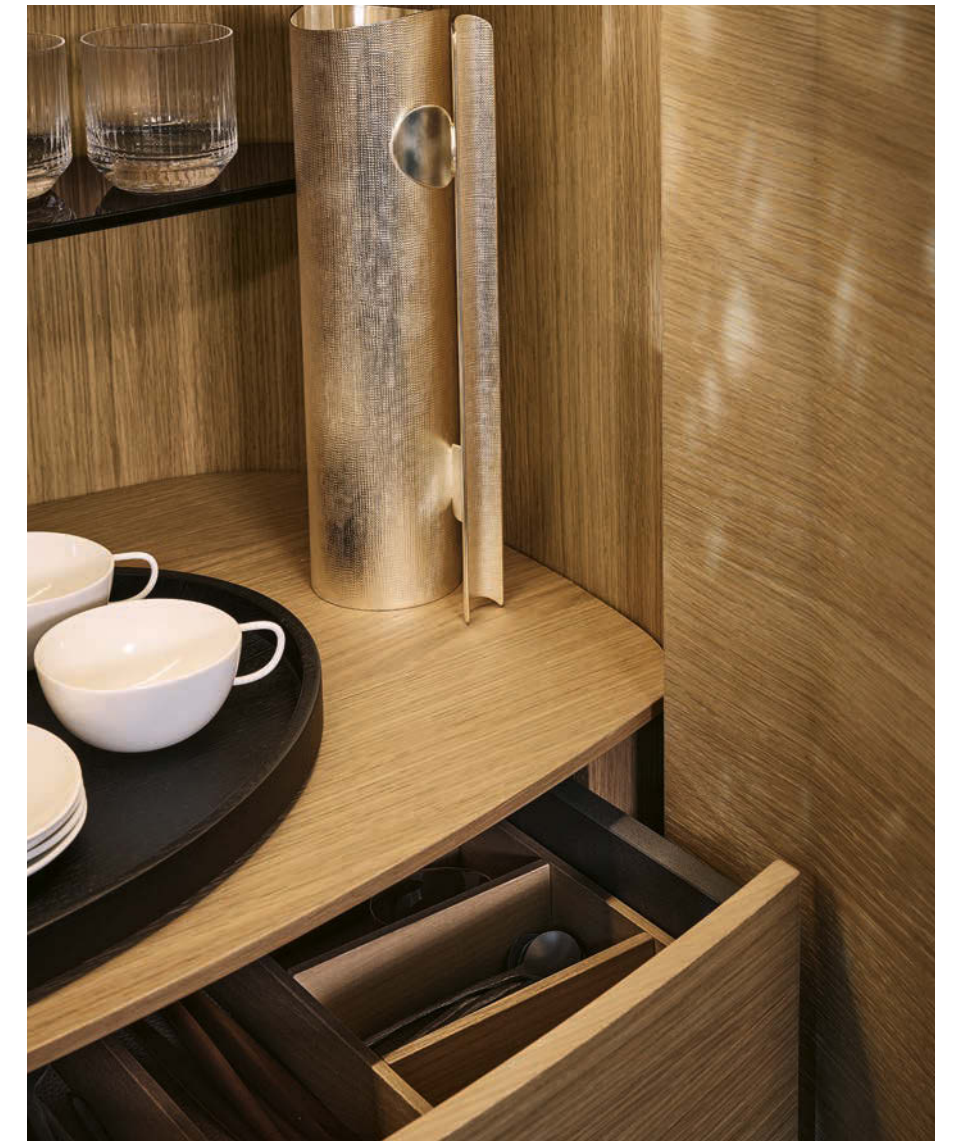

In questa pagina: madia Symphony in olmo nero con top in marmo sahara noir levigato finitura poliesteri, basamento con piedini e maniglia in brown nickel opaco. Interno struttura in olmo nero, cassetteria in olmo nero e ripiano in vetro fumé, luce a led integrata con sensore.

This page: Symphony sideboard in black elm with top in mat Sahara noir marble with polyester finish, base with feet and handle in mat brown nickel. Black elm inner structure, black elm chest of drawers and fumé glass shelf, integrated led light with sensor.







In questa pagina: madia Symphony in olmo nero, basamento con piedini e maniglia in brown nickel opaco. Nella pagina successiva: madia Symphony in rovere gold con top in marmo zecevo levigato, ante battenti con maniglie in brown nickel opaco, vano a giorno e basamento con piedini in brown nickel opaco. Boiserie Code in tessuto lino écru con profili in champagne opaco. Libreria Lexington in rovere gold e champagne opaco. Divano Saint-Germain in tessuto sfoderabile Agadir 03 pepe, cuscini in tessuto Nancy 100 cenere e velluto Persia 1404 carbone, piedini brown nickel opaco. Tavolino Koishi con piano in vetro blu riflettente e struttura in champagne opaco. Tappeto Relief cammello.

This page: Symphony sideboard in black elm, mat brown nickel base with feet and handle. Next page: Symphony sideboard in gold oak with top in mat marble zecevo, leaf doors with handles in mat brown nickel, open compartment and base with feet in mat brown nickel. Code wall panelling in fabric lino écru with mat champagne profiles. Lexington bookcase in gold oak and mat champagne. Saint-Germain sofa in removable fabric Agadir 03 pepe, cushions in fabric Nancy 100 cenere and velvet Persia 1404 carbone, mat brown nickel feet. Koishi coffee table with top in blu reflecting glass and mat champagne structure. Carpet Relief cammello.









In questa pagina: madia Symphony in rovere gold con top in marmo zecevo levigato, vano a giorno e basamento con piedini in brown nickel opaco. Ante battenti con maniglie in brown nickel opaco, ripiani interni in vetro fumé.

This page: Symphony sideboard in gold oak with top in mat marble zecevo, open compartment and base with feet in mat brown nickel. Leaf doors with handles in mat brown nickel, inner shelves in glass fumé.

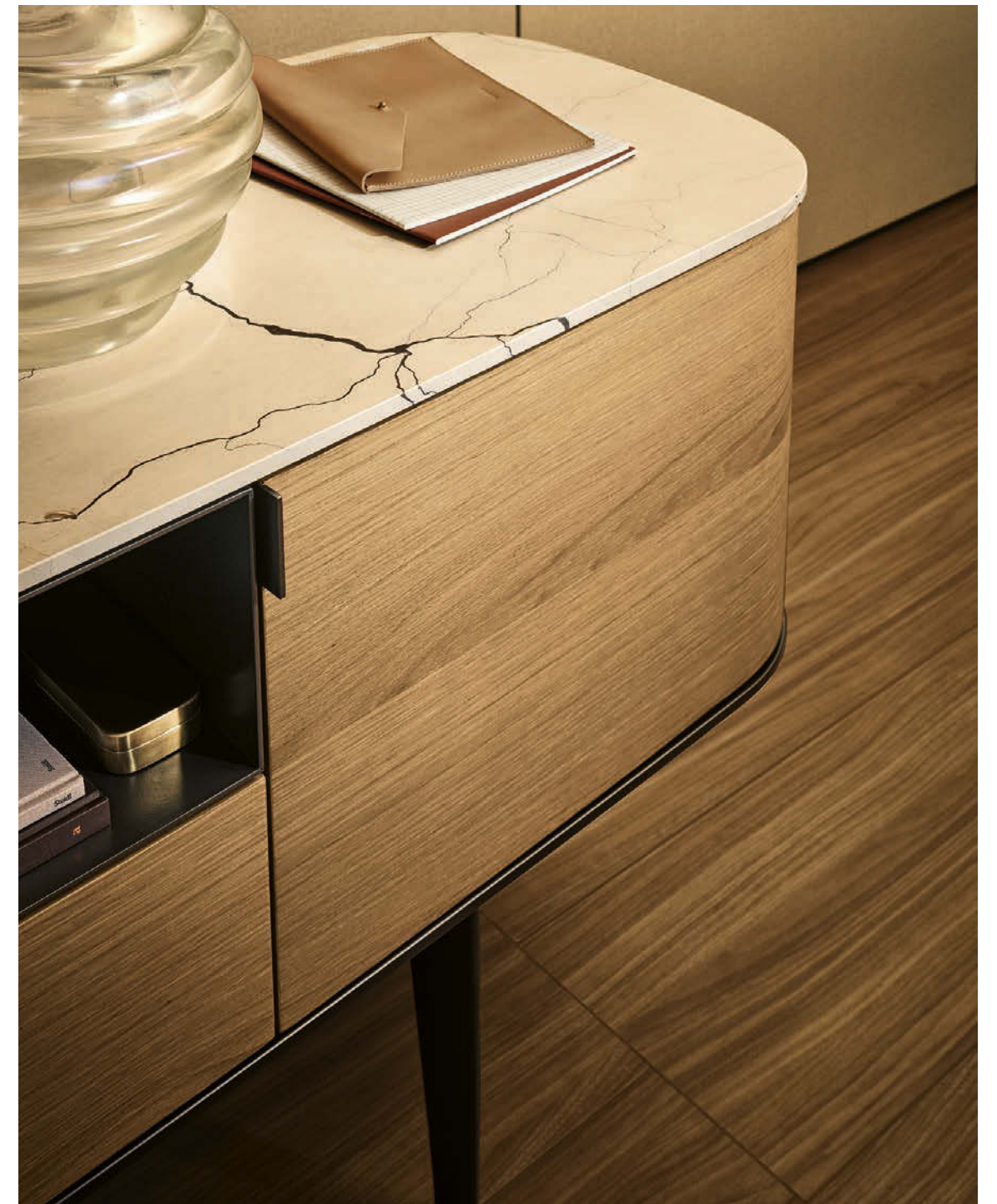







Qui e nella pagina precedente: madia Symphony in rovere gold con top in marmo zecevo levigato, basamento con piedini in champagne opaco. Ante battenti con maniglie in champagne opaco, ripiani interni in vetro fumé.

This and previous page: Symphony sideboard in gold oak with mat zecevo marble top, mat champagne base with feet. Leaf doors with handles in mat champagne, inner shelves in glass fumé.







Qui e nella pagina precedente: madia Symphony in olmo nero, basamento con piedini in brown nickel opaco. Ante battenti con maniglie in brown nickel opaco, ripiani interni in vetro fumé.

This and previous page: Symphony sideboard in black elm, mat brown nickel base with feet. Leaf doors with handles in mat brown nickel, inner shelves in glass fumé.

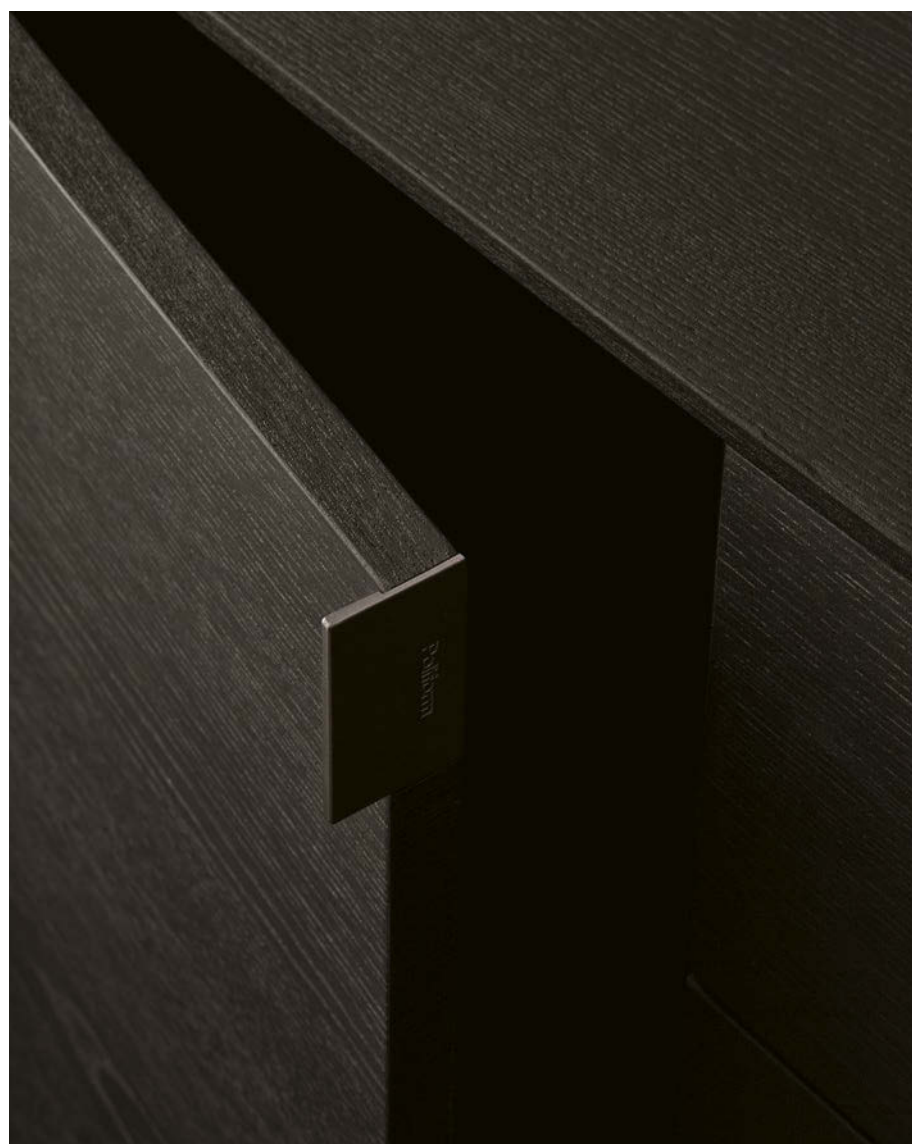
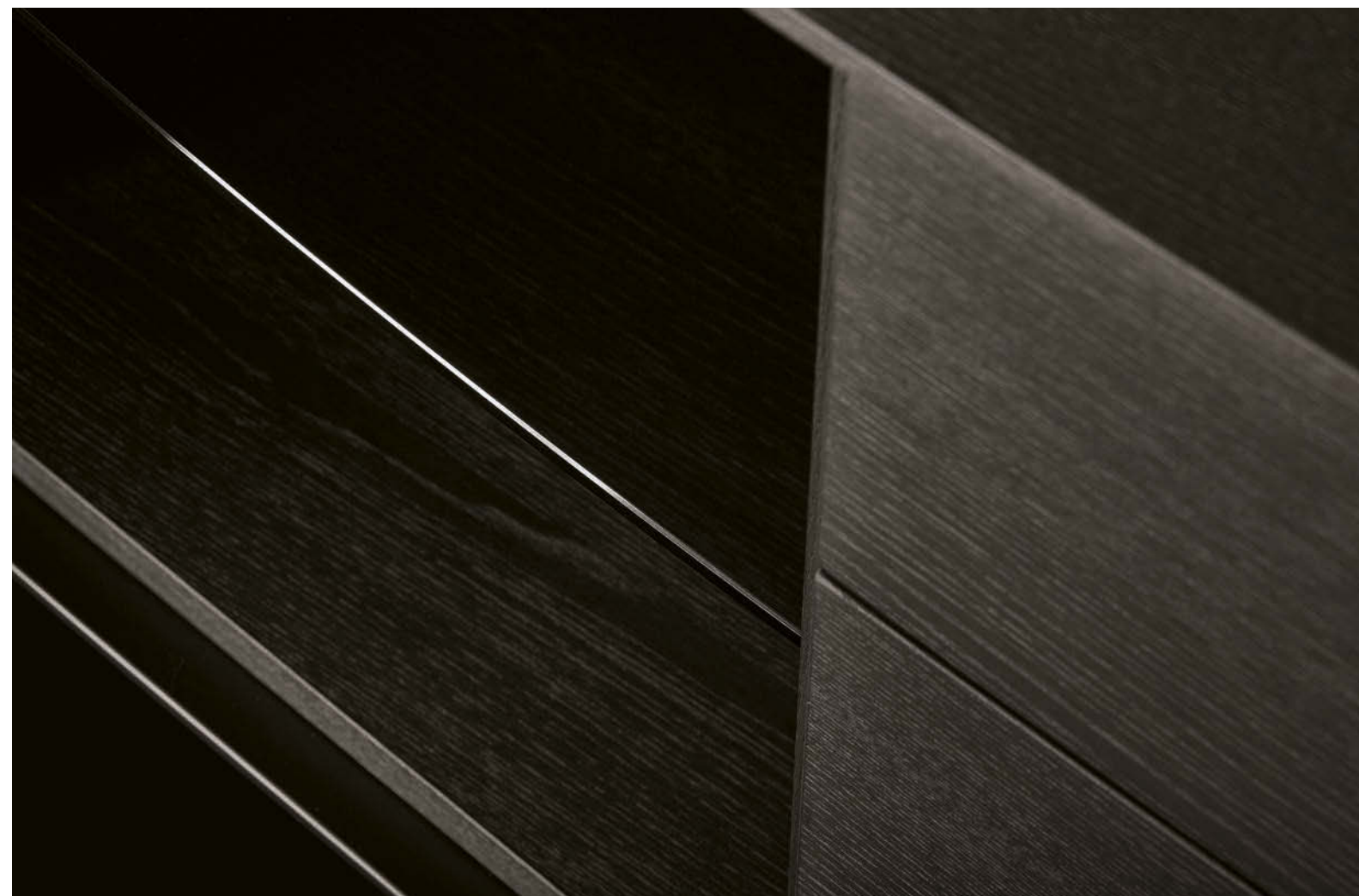







Qui e nella pagina precedente: madia Symphony in rovere gold con vano a giorno e basamento con piedini in brown nickel opaco. Ante battenti con maniglie in brown nickel opaco, ripiani interni in vetro fumé.

This and previous page: Symphony sideboard in gold oak with open compartment and base with feet in mat brown nickel. Leaf doors with handles in mat brown nickel, inner shelves in glass fumé.

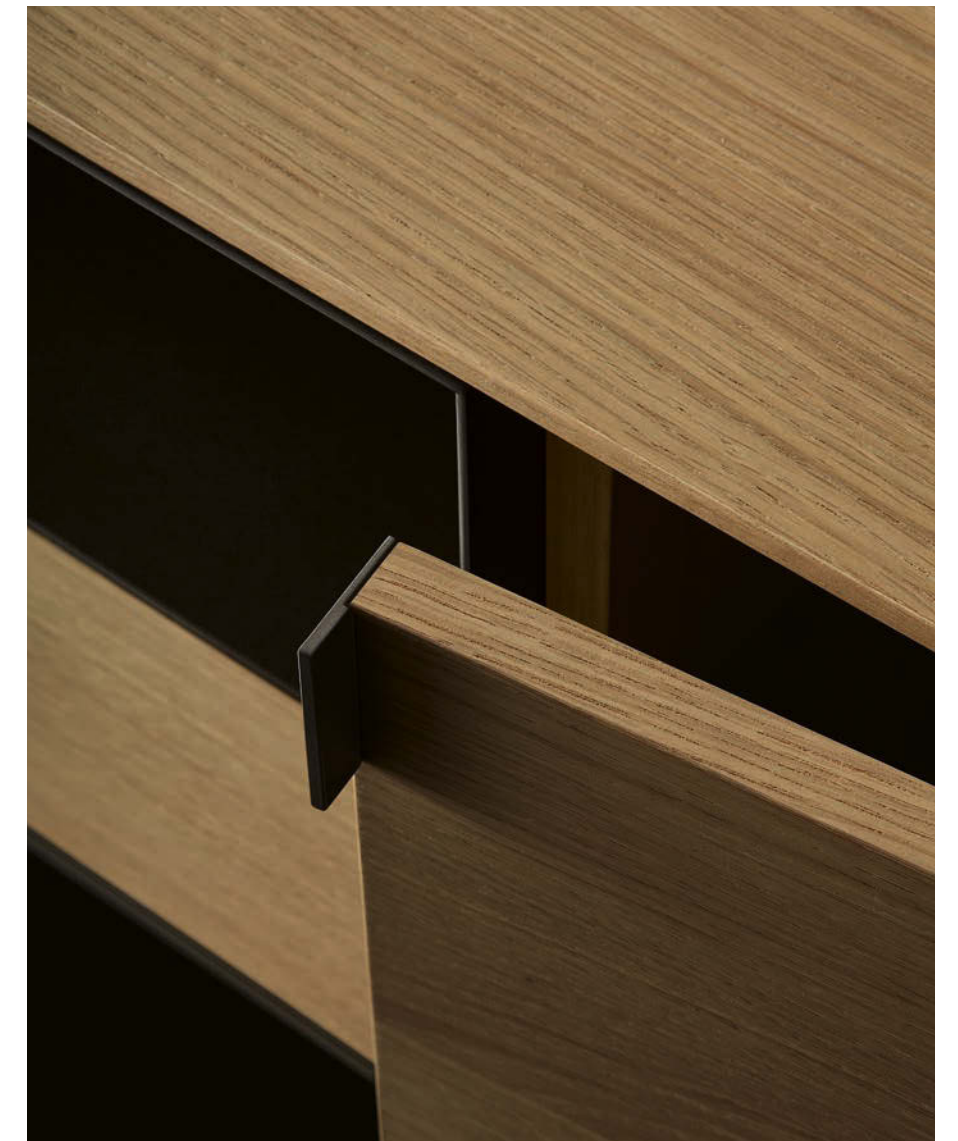

# SYMPHONY

Design Emmanuel Gallina, 2021

Struttura e frontali in rovere gold o olmo nero. Symphony bassa con vano a giorno in metallo verniciato brown nickel opaco o champagne opaco. Top in rovere gold, olmo nero o marmo levigato e lucido (escluso emperador dark).

Maniglie, basamento e piedini in metallo verniciato brown nickel opaco o champagne opaco.

Attrezzature madie Symphony h 580/680: nel vano a destra un ripiano in vetro fumé, nella versione con vano a giorno è prevista la predisposizione passaggio cavi.

Attrezzature madia Symphony h 755/855: due ripiani in vetro fumé.

Attrezzature madia Symphony h 1000/1100: cassetto interno con portaposate e fondo in tecnocover Grain; un ripiano in vetro fumé.

Attrezzature madia Symphony h 1300/1400: un ripiano in vetro fumé, cassetto con portaposate e fondo in tecnocover Grain oppure due ripiani in legno e uno opzionale in vetro fumé; luce a led integrata con sensore.

Structure and fronts in gold oak and black elm. Low sideboard Symphony with open compartment in metal painted mat brown nickel or mat champagne. Top in gold oak, black elm or mat and glossy marble (except emperador dark). Handles, base and metal feet painted mat brown nickel or mat champagne. Equipment for sideboard Symphony h 22 3/4"/26 3/4": one shelf in fume glass in the right compartment, in the version with open compartment a cable passage arrangement is foreseen. Equipment for sideboard Symphony h 29 3/4"/33 3/4": two shelves in fume glass. Equipment for sideboard Symphony h 39 1/4"/43 1/4": inner drawer with cutlery tray and bottom covered in tecnocover Grain; one shelf in fume glass. Equipment for sideboard Symphony h 51 1/4"/55": one shelf in fume glass, chest of drawers with cutlery tray and bottom covered in tecnocover Grain or two shelves in wood and one optional shelf in fume glass; integrated led light with sensor.

## Piedini h 200 Feet h 7 3/4"

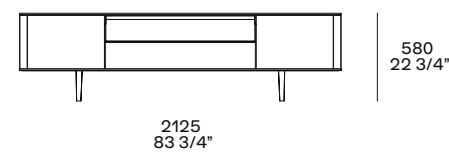

due ante battenti, un cassetto e un vano a giorno  
two leaf doors, one drawer and one open compartment

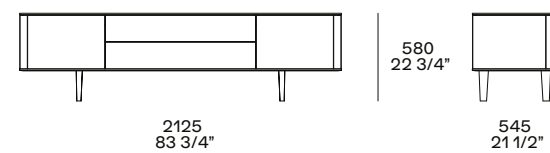

due ante battenti e due cassetti  
two leaf doors and two drawers

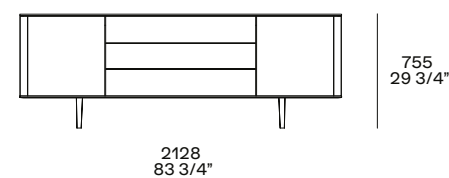

due ante battenti e tre cassetti  
two leaf doors and three drawers

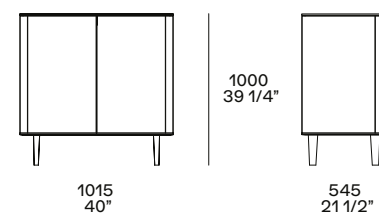

due ante battenti  
two leaf doors

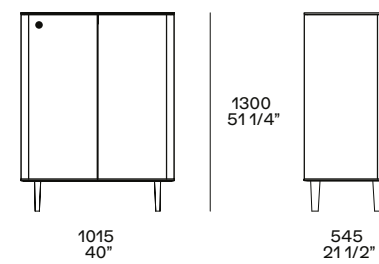

due ante battenti  
two leaf doors

## Piedini h 300 Feet h 11 3/4"

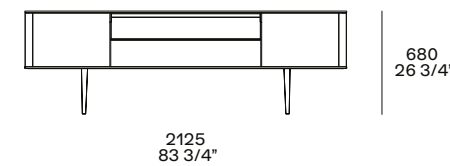

due ante battenti, un cassetto e un vano a giorno  
two leaf doors, one drawer and one open compartment

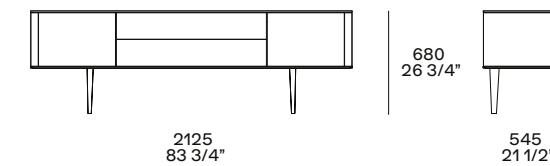

due ante battenti e due cassetti  
two leaf doors and two drawers

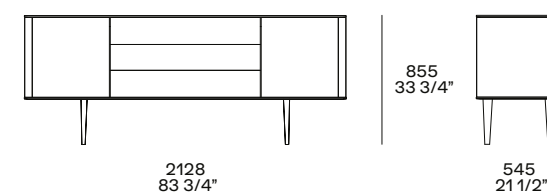

due ante battenti e tre cassetti  
two leaf doors and three drawers

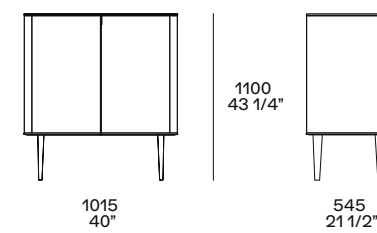

due ante battenti  
two leaf doors

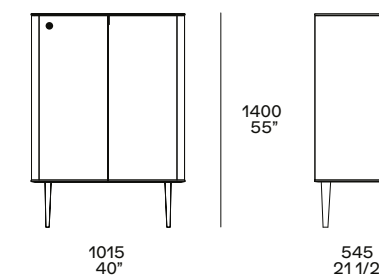

due ante battenti  
two leaf doors

● luce a led integrata con sensore  
integrated led light with sensor





# CODE

La collezione di madie Code completa l'omonimo sistema con una serie di contenitori disponibili in diverse configurazioni – con vani a giorno, cassetti e ante battenti o a ribalta. La versatilità del sistema si ritrova nella varietà di finiture, che danno a ogni madia uno stile diverso – più classico o più contemporaneo.

The Code sideboard collection completes the homonymous system with a series of containers available in different configurations – with open compartments, drawers, and hinged or folding doors. The versatility of the system can also be found in the variety of finishes, which give each sideboard a different style – more classic or more contemporary.





Qui e nella pagina precedente: madia Code in noce gold con top in laccato metallico bronzo, vano a giorno in laccato opaco bronzo, zoccolino in ardesia opaco. Mensolone Code sospeso retroilluminato in laccato opaco granata. Poltrona Kay Lounge in pelle non sfoderabile Hairy bianco/nero, struttura in cromo satinato. Tavolini Nara in legno massello tinto olmo nero. Divano Westside in tessuto sfoderabile Arcadia 02 sabbia, cuscini in velluto Tebe 06 giada, basamento in brown nickel opaco. Tavolini Westside, piano in marmo zecevo levigato e olmo nero, struttura in olmo nero e brown nickel opaco. Tappeto Tratto carbone.

This and previous page: Code sideboard in gold walnut with top in metal lacquer bronze, open compartment in mat lacquer bronze, plinth in mat ardesia. Code backlit suspended thick shelf in mat lacquer granata. Kay Lounge armchair in non-removable leather Hairy white/black, structure in brushed chrome. Nara coffee tables in solid wood stained black elm. Westside sofa in removable fabric Arcadia 02 sabbia, cushions in velvet Tebe 06 giada, mat brown nickel base. Westside coffee tables, top in mat marble zecevo and black elm, structure in black elm and mat brown nickel. Carpet Tratto carbone.









Qui e nella pagina precedente: madia Code in laccato opaco visone con top in marmo sahara noir levigato finitura poliester e basamento con piedini ardesia opaco. Cassetti con fondo opzionale in tecnocover Grain 02 moro.

This and previous page: Code sideboard in mat lacquer visone with top in mat marble sahara noir polyester finish and base with feet mat ardesia. Drawers with optional bottom in tecnocover Grain 02 moro.







Qui e nella pagina precedente: madia Code in rovere gold con top in laccato metallico bronzo e basamento con piedini ardesia opaco. Vano a giorno in laccato opaco ardesia e cassetti con fondo opzionale in tecnocover Grain 05 latte. Sotto: dettaglio dei vassoi opzionali con struttura verniciata ardesia e fondo in tecnocover Grain 05 latte.

This and previous page: Code sideboard in gold oak with top in metal lacquer bronze and base with feet mat ardesia. Open storage unit in mat lacquer ardesia and drawers with optional bottom in tecnocover Grain 05 latte. Below: close up of the optional trays with structure painted ardesia and bottom in tecnocover Grain 05 latte.

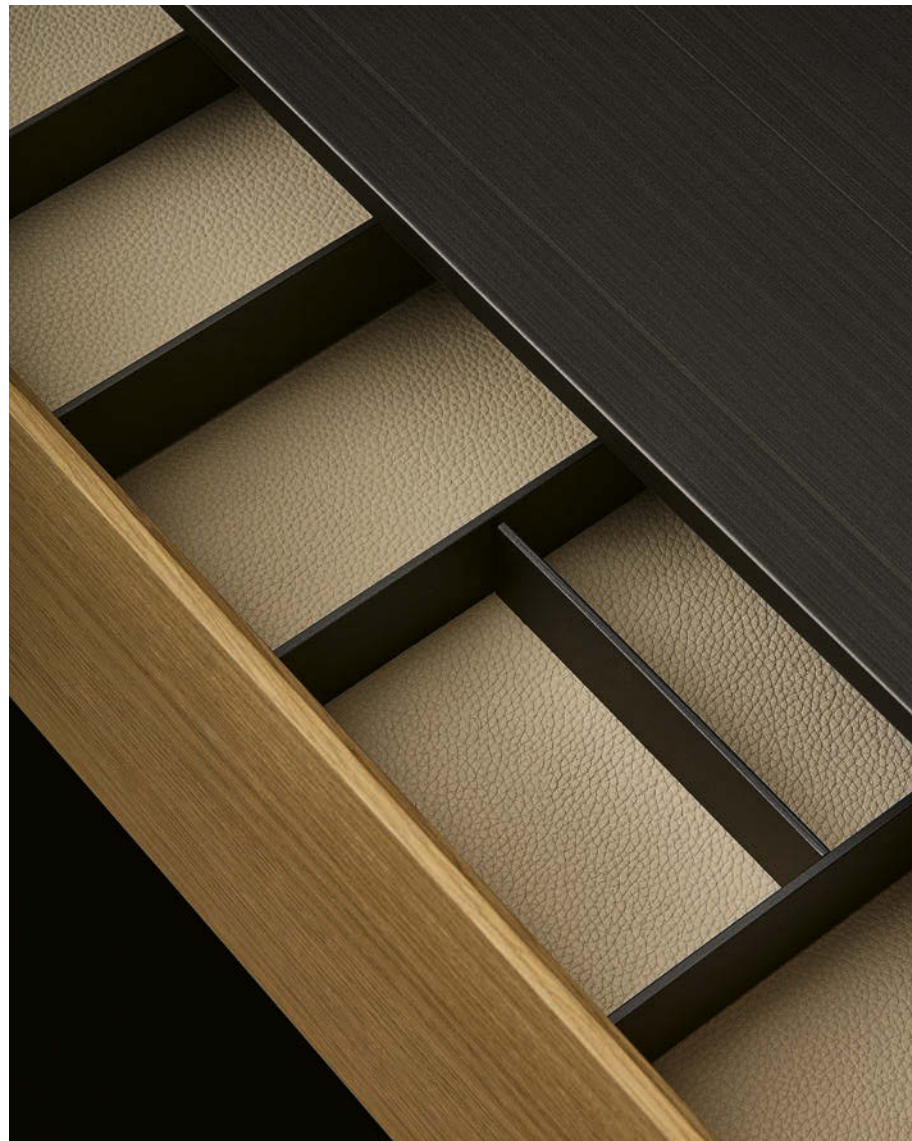







Qui e nella pagina precedente: madia Code in olmo nero con top in marmo zecevo levigato e basamento con piedini ardesia opaco. Contenitori vetrina con luce a led integrata, ante in vetro trasparente riflettente, struttura interna in olmo nero con schienale in tessuto lino chiaro, ripiano in vetro trasparente. Vano a giorno con luce a led integrata, struttura interna in laccato opaco bronzo e schienali in olmo nero. Tavolo Henry in olmo nero con piano in marmo sahara noir levigato finitura poliester. Sedie Sophie in tessuto non sfoderabile Kitami 04 sabbia e struttura in olmo nero. Tappeto Tratto ruggine. Sotto: dettaglio del cassetto in laccato metallico bronzo, fondo in tecnocover Grain 06 nocciola con portaposate in ardesia opaco, piano superiore in laccato metallico bronzo.

This and previous page: Code sideboard in black elm with top in mat marble zecevo and base with feet mat ardesia. Display case storage units with integrated led light, doors in transparent glass, inner structure in black elm with back in fabric lino chiaro, shelf in transparent reflecting glass. Open compartment with integrated led light, inner structure in mat lacquer bronzo and backs in black elm. Henry table in black elm with top in mat marble sahara noir with polyester finish. Sophie chairs in non-removable fabric Kitami 04 sabbia and structure in black elm. Carpet Tratto ruggine. Below: close up of the drawer in metal lacquer bronzo, bottom in tecnocover Grain 06 nocciola with cutlery tray in mat ardesia, upper shelf in metal lacquer bronzo.



In questa pagina: madia Code in laccato metallico ottone con schienali in noce gold e struttura interna in laccato opaco ottone. Contenitori vetrina con luce a led integrata, ante in vetro trasparente riflettente con telaio e maniglia in ardesia opaco, ripiani in vetro trasparente, frontali cassetti in laccato metallico ottone. Vano a giorno con luce a led integrata, ripiani in laccato opaco ottone. Basamento con piedini ardesia opaco.

This page: Code sideboard in metal lacquer ottone with backs in gold walnut and inner structure in mat lacquer ottone. Display case storage units with integrated led light, doors in transparent reflecting glass with frame and handle in mat ardesia, shelves in transparent glass, and drawer fronts in metal lacquer ottone. Open compartment with integrated led light, shelves in mat lacquer ottone. Base with feet in mat ardesia.







Qui e nella pagina precedente: madia Code con fianchi in laccato opaco visone e top in marmo zecevo levigato. Ante in vetro trasparente riflettente con telaio e maniglia in ardesia opaco, ripiani in vetro trasparente. Schienali in tessuto lino chiaro e struttura interna in laccato opaco visone. Basamento con piedini ardesia opaco.

This and previous page: Code sideboard with sides in mat lacquer visone and top in mat marble zecevo. Doors in transparent reflecting glass with frame and handle in mat ardesia, shelves in transparent glass. Backs in fabric lino chiaro and inner structure in mat lacquer visone. Base with feet mat ardesia.

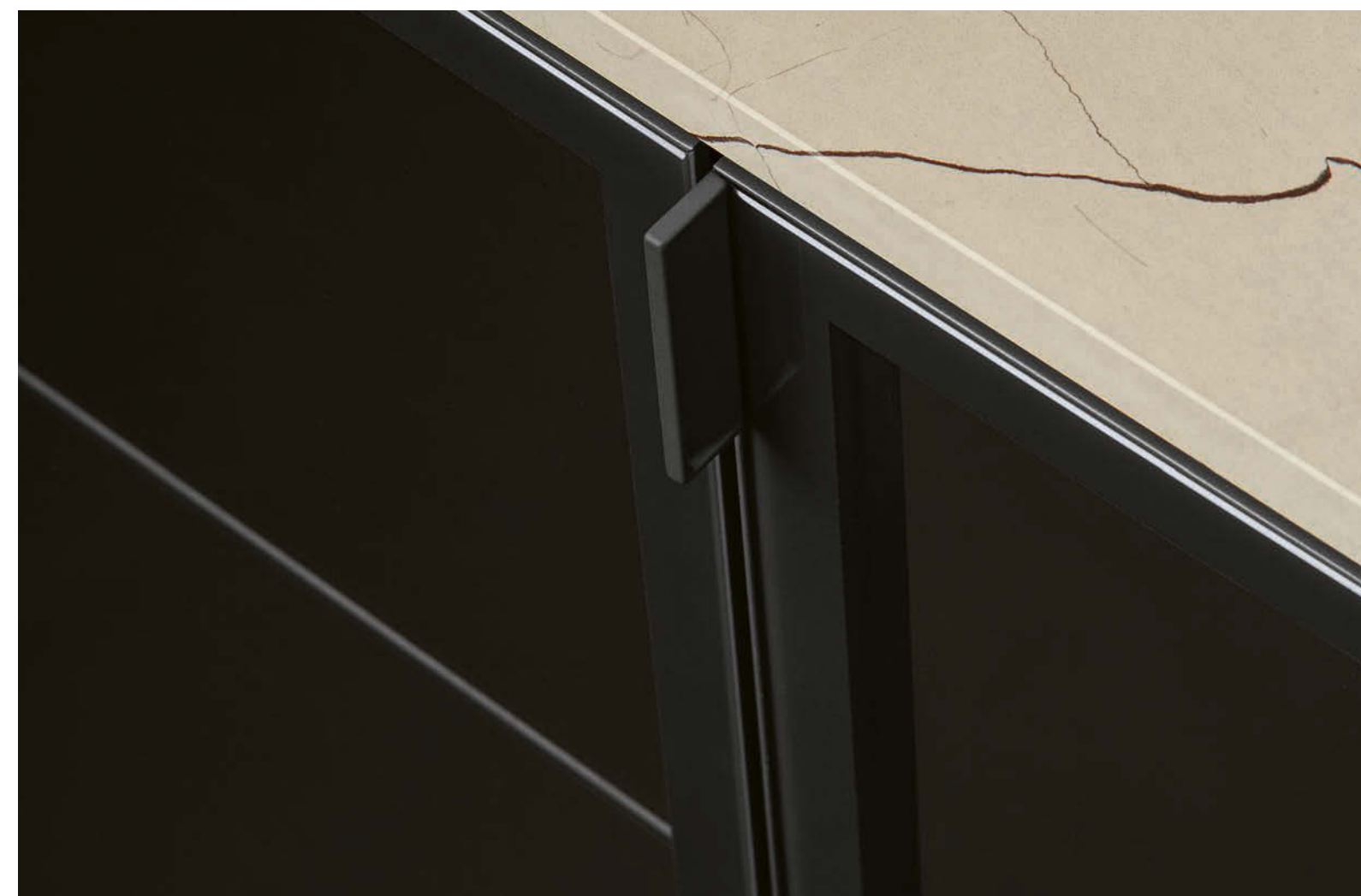





In questa pagina: madia Code in noce gold e basamento con piedi champagne opaco. Vano a giorno in laccato opaco champagne con schienale in specchio bronzo e luce a led integrata, top interno in marmo zecevo levigato. Contenitore con ante battenti, maniglia in champagne opaco, vassoio superiore con fondo in tecnocover Grain 06 nocciola. Poltrona Gentleman Relax in tessuto sfoderabile Siro 02 lino con basamento in brown nickel lucido. Tappeto Plain tortora.

This page: Code sideboard in gold walnut and base with feet champagne. Open compartment in mat lacquer champagne with back in bronzed mirror and integrated led light, inner top shelf in mat marble zecevo. Storage unit with leaf doors, mat champagne handle, upper tray with bottom in tecnocover Grain 06 nocciola. Gentleman Relax armchair in removable fabric Siro 02 lino with base in glossy brown nickel. Carpet Plain tortora.

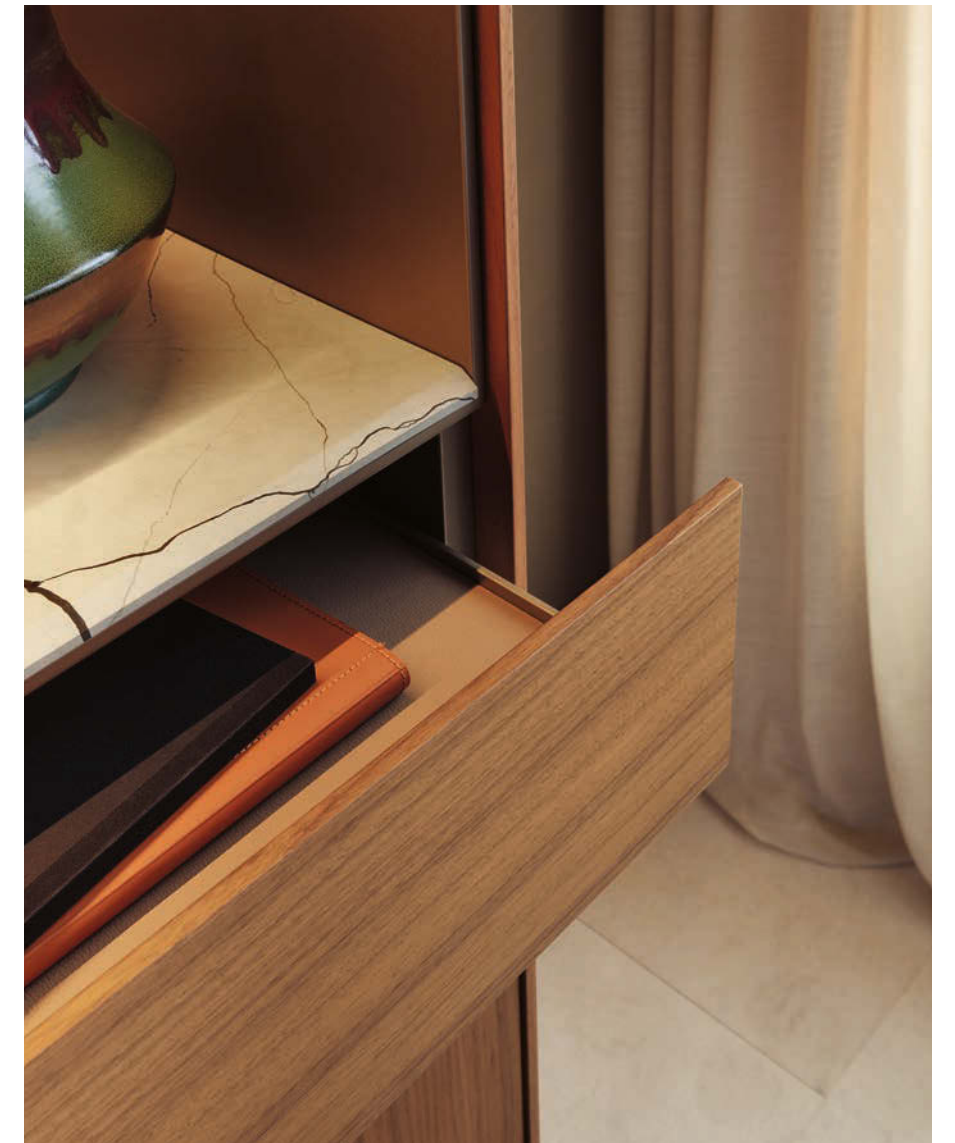

In questa pagina: madia Code in laccato metallico bronzo e basamento con piedini ardesia opaco. Vano a giorno con luce a led integrata, schienale in tessuto lino scuro e top interno in marmo sahara noir levigato finitura poliester. Sotto: dettaglio del vassoio con fondo in tecnocover Grain 06 nocciola.

This page: Code sideboard in metal lacquer bronzo and base with feet in mat ardesia. Open compartment with integrated led light, back in fabric lino scuro and inner top shelf in mat marble sahara noir with polyester finish. Below: close up of the tray with bottom in tecnocover Grain 06 nocciola.

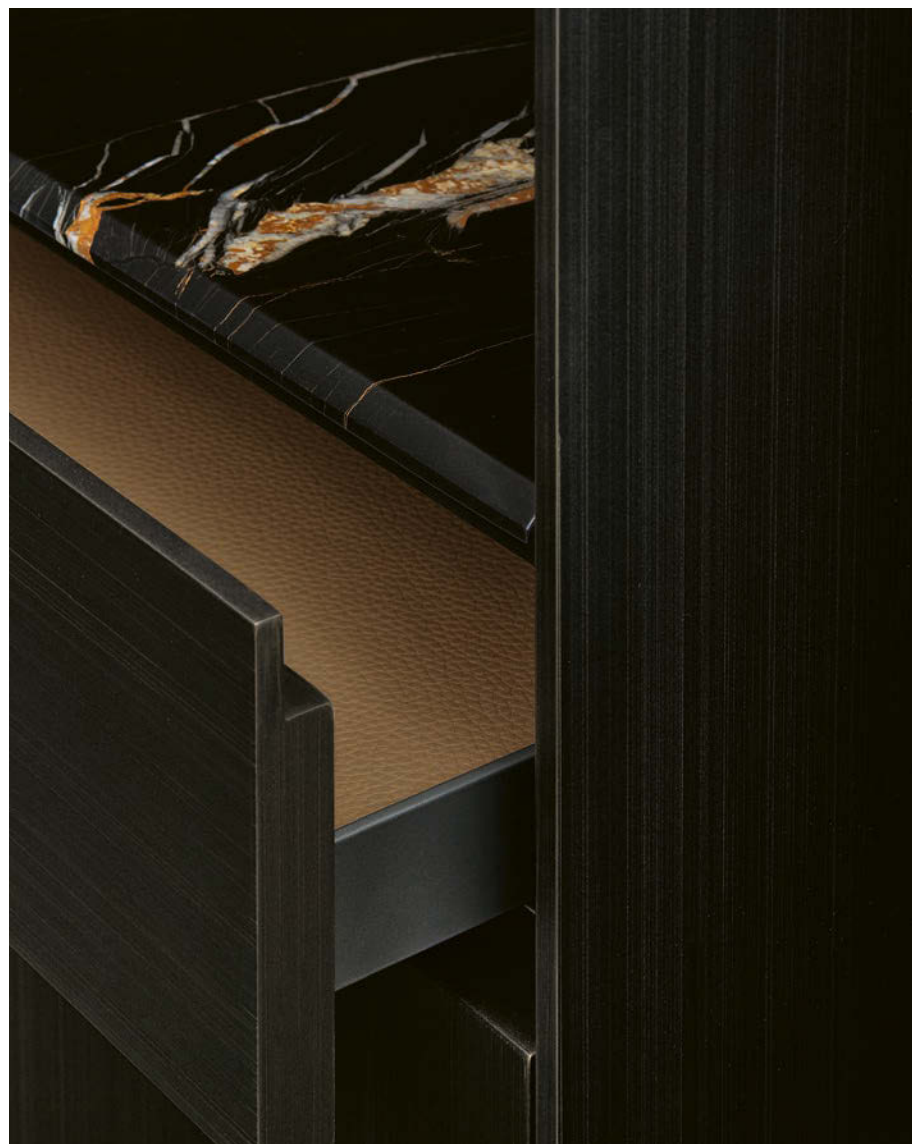





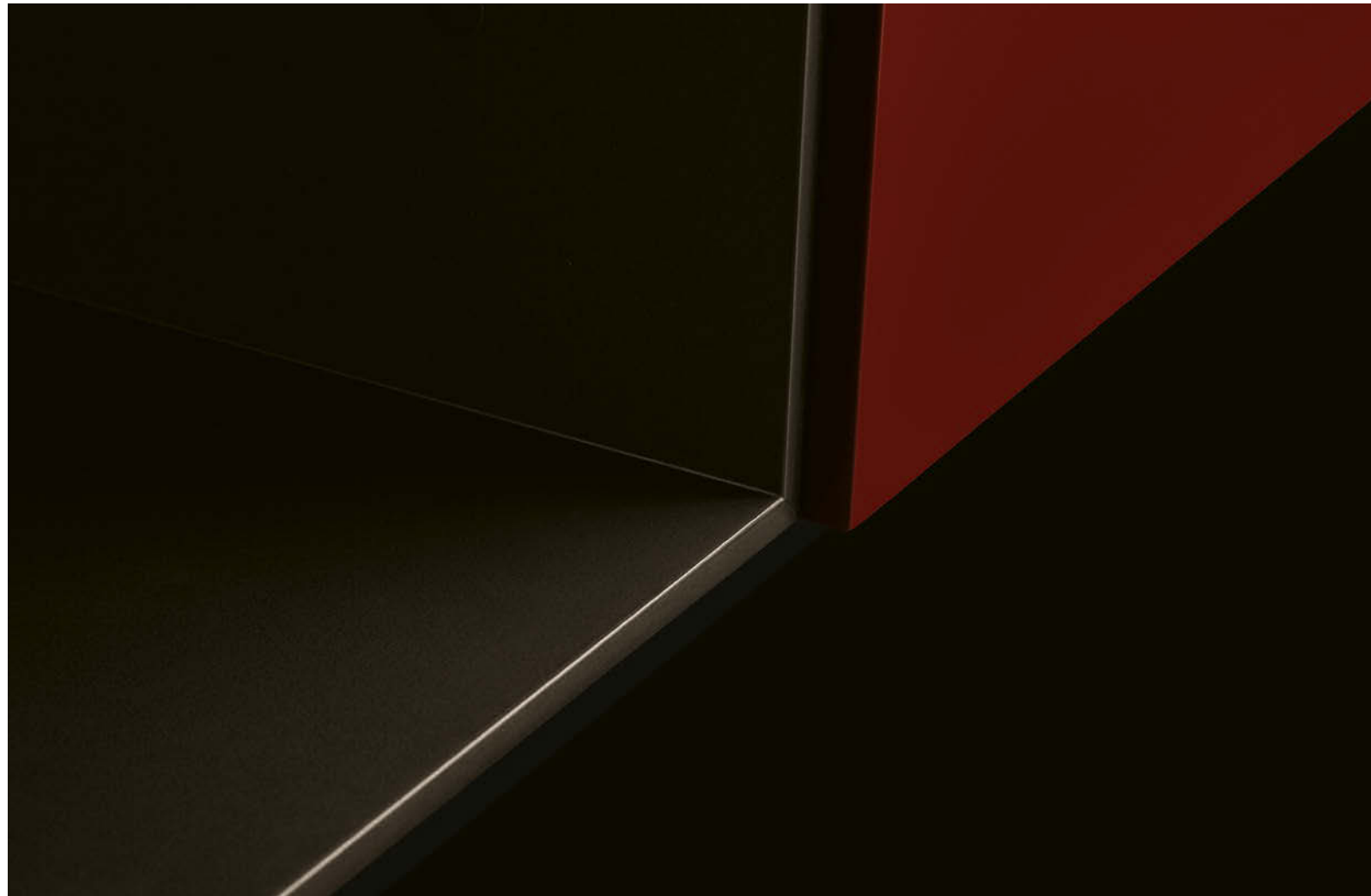

Nella pagina precedente: madia Code in olmo nero e basamento con piedini in champagne opaco. In questa pagina e nella successiva: madia Code in laccato opaco granata con top in laccato metallico ottone. Vano a giorno in laccato opaco ottone. Basamento con zoccolino in ardesia opaco.

Previous page: Code sideboard in black elm and base with feet mat champagne. This and next page: Code sideboard in mat lacquer granata with top in metal lacquer ottone. Open compartment in mat lacquer ottone. Base with plinth in mat ardesia.









In questa pagina: madia Code in noce gold con top in marmo zecevo levigato, vani a giorno e struttura interna in laccato opaco ottone, basamento con piedini in champagne opaco. Boiserie Code in tessuto lino chiaro e profili champagne opaco. Specchio Circle, cornice in cuoio 02 nero e specchio bianco. Pouf New York in tessuto sfoderabile Antea 05 terra di siena. Sotto: dettaglio del top attrezzato con passacavi in champagne opaco.

This page: Code sideboard in gold walnut with top in mat marble zecevo, open compartments and inner structure in mat lacquer ottone, base with feet in mat champagne. Code wall panelling in fabric lino chiaro and mat champagne profiles. Circle mirror, frame in hide 02 nero and white mirror. New York pouf in removable fabric Antea 05 terra di siena. Below: close up of the accessorized top with cable passage channel in mat champagne.

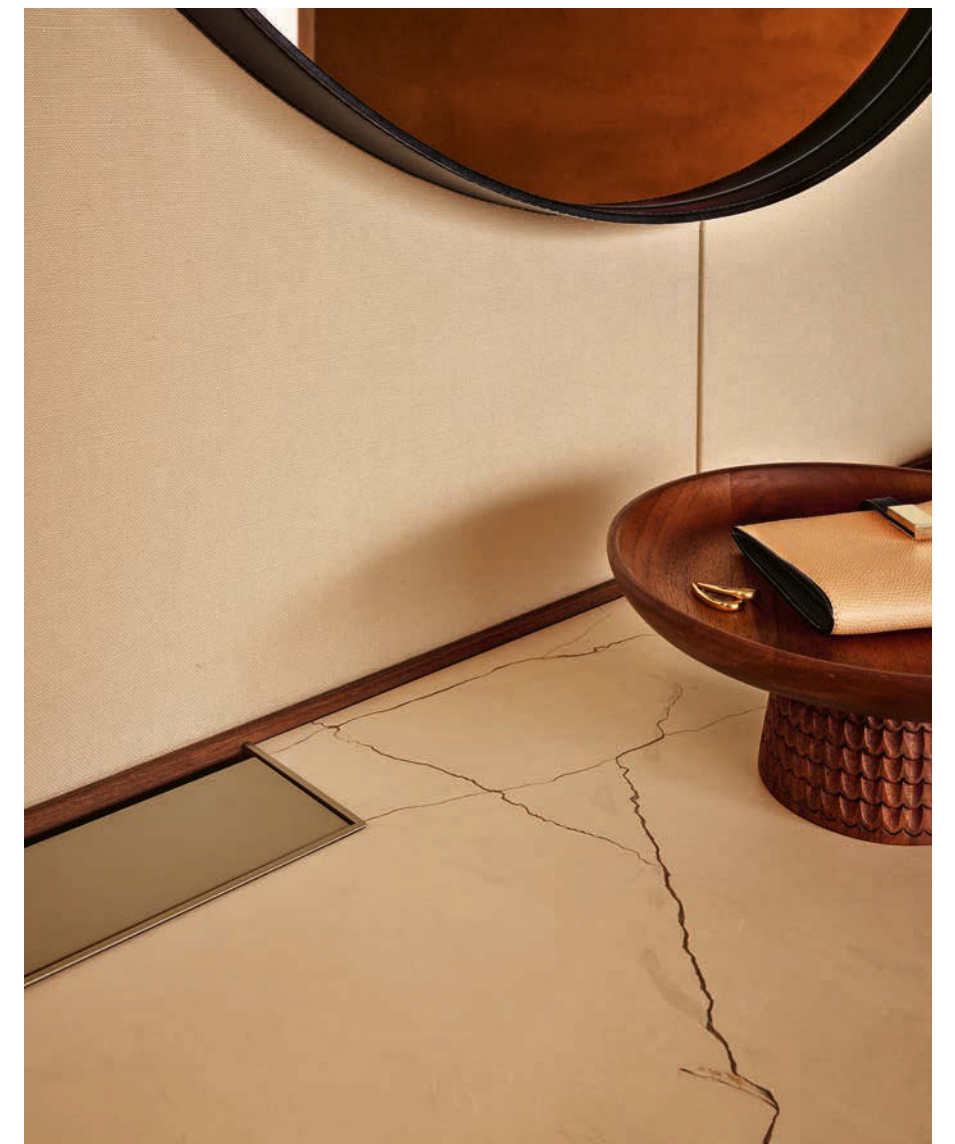



## CODE SIDEBOARDS

Design R&D Poliform, 2019

### Frontali, fianchi laterali, retro schienale

Laccato opaco colori, laccato metallico colori, 4 essenze.

### Frontali vetro

Vetro trasparente e fumé, vetro riflettente trasparente e fumé, telaio ardesia o champagne opaco.

### Vani a giorno

Laccato opaco colori.

Schienale: laccato opaco colori, laccato metallico colori, 4 essenze, tessuto 4 colori.

### Top di finitura

Laccato opaco colori, laccato metallico colori, 4 essenze, marmo levigato e lucido.

### Basamento con piedini, zoccolino

Metallo verniciato ardesia opaco o champagne opaco.

### Struttura

Nobilitato ardesia (incluso schienale), laccato opaco colori, 4 essenze.  
Schienale: laccato opaco colori, laccato metallico colori, 4 essenze, tessuto 4 colori.

### Ripiani interni

Nobilitato ardesia, laccato opaco colori, 4 essenze, vetro trasparente.

### Cassettiera interna

Frontali: laccato opaco colori, laccato metallico colori, 4 essenze.  
Top: laccato opaco colori, laccato metallico colori, 4 essenze, marmo levigato e lucido.

### Fondo opzionale cassette

Tecnocover Grain colori.

### Piano panca

Laccato opaco colori, laccato metallico colori, 4 essenze.



basamento con piedini h 265 mm  
base with feet h 10 1/2"

Le 4 essenze disponibili per le madie  
Code sono: rovere gold, rovere spessart,  
noce gold o olmo nero.

### Fronts, lateral sides, back part of the back panel

Mat lacquered colours, metal lacquered colours, 4 woods.

### Glass fronts

Transparent and fumé glass, transparent and fumé reflecting glass, mat ardesia or champagne frame.

### Open storage units

Mat lacquered colours.  
Back: mat lacquered colours, metal lacquered colours, 4 woods, fabric 4 colours.

### Finishing top

Mat lacquered colours, metal lacquered colours, 4 woods, mat and glossy marble.

### Base with feet, plinth

Mat ardesia or champagne painted metal.

### Structure

Melamine ardesia (including back), mat lacquered colours, 4 woods.  
Back: mat lacquered colours, metal lacquered colours, 4 woods, fabric 4 colours.

### Inner shelves

Melamine ardesia, mat lacquered colours, 4 woods, transparent glass.

### Inner chest of drawers

Fronts: mat lacquered colours, metal lacquered colours, 4 woods.  
Top: mat lacquered colours, metal lacquered colours, 4 woods, mat and glossy marble.

### Optional drawers bottom

Tecnocover Grain colori.

### Bench top

Mat lacquered colours, metal lacquered colours, 4 woods.

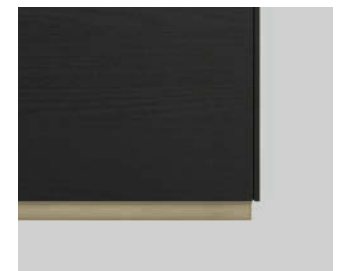

zoccolino h 40 mm  
plinth h 1 1/2"

The 4 available woods for the Code sideboards are: gold oak, spessart oak, gold walnut or black elm.

### h 566 con piedini - h 341 con zoccolino h 22 1/4" with feet - h 13 1/2" with plinth



### h 669 con piedini - h 444 con zoccolino h 26 1/4" with feet - h 17 1/2" with plinth

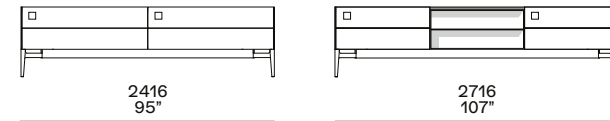

### h 769 con piedini - h 544 con zoccolino h 30 1/4" with feet - h 21 1/2" with plinth

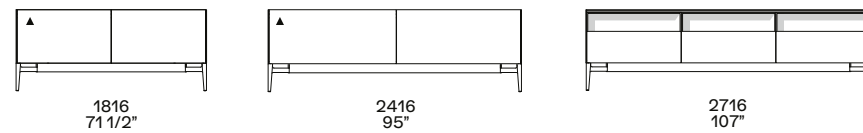

### h 872 con piedini - h 647 con zoccolino h 34 1/4" with feet - h 25 1/2" with plinth

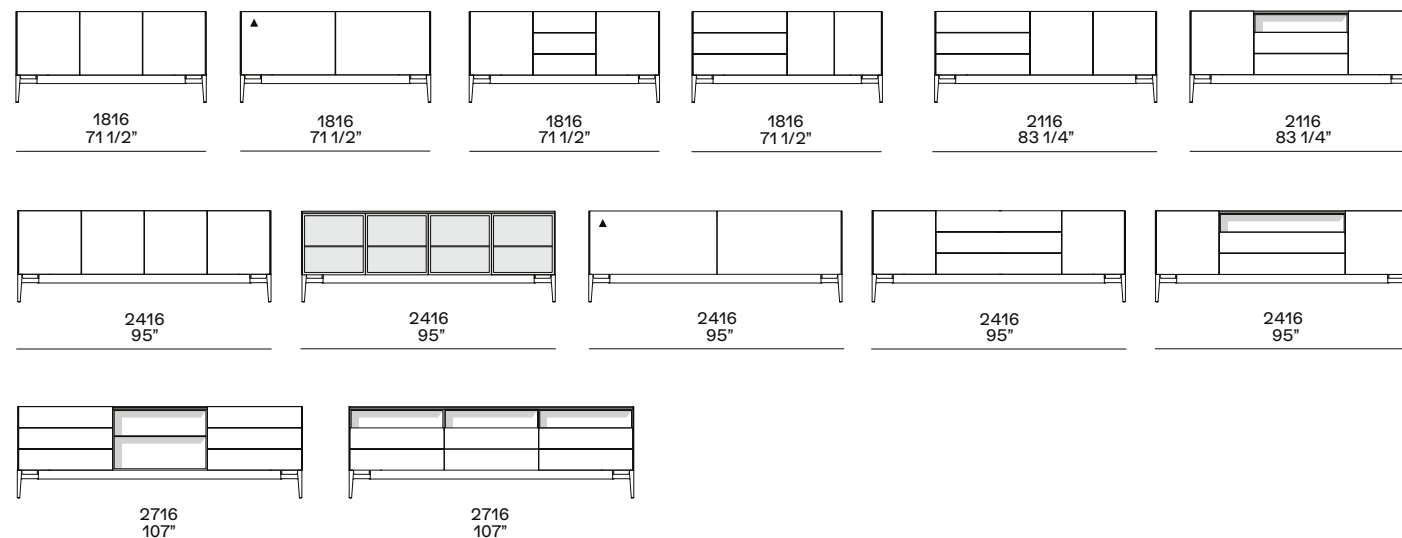

### Madia alta - h 1454 con piedini - h 1229 con zoccolino High sideboard - h 57 1/4" with feet - h 48 1/2" with plinth

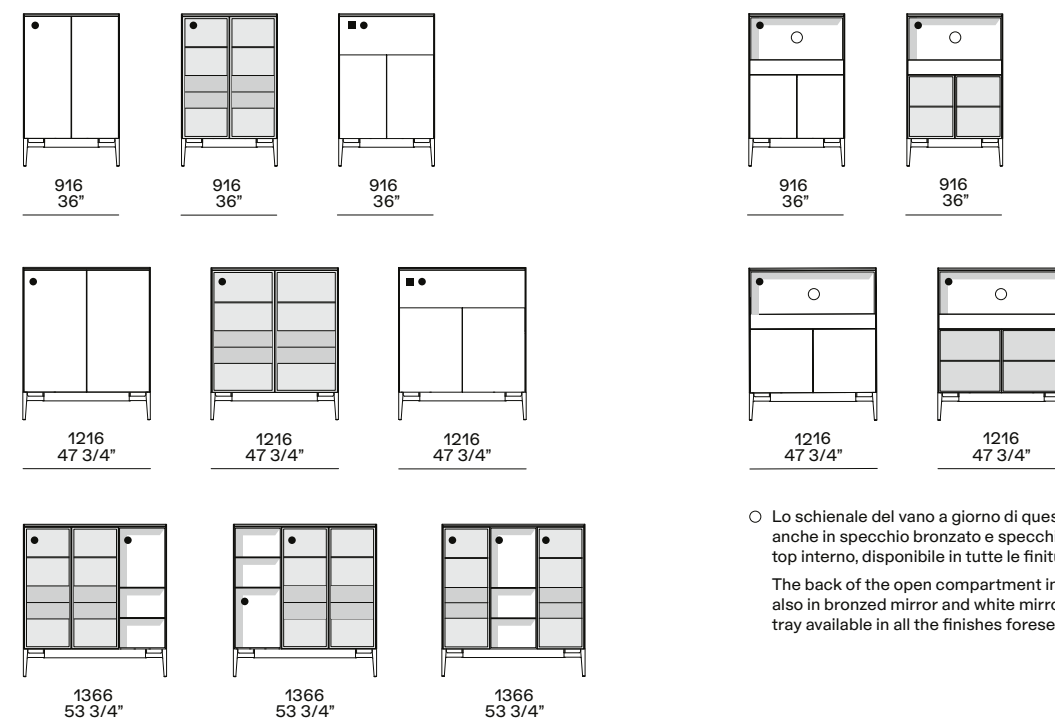

○ Lo schienale del vano a giorno di queste quattro configurazioni è disponibile anche in specchio bronzato e specchio bianco. Sopra al vassoio è previsto un top interno, disponibile in tutte le finiture previste per i top.

The back of the open compartment in these four configurations is available also in bronzed mirror and white mirror. An internal top is provided above the tray available in all the finishes foreseen for tops.

### Panca h 325 con piedini - h 100 con zoccolino Bench h 12 3/4" with feet - h 4" with plinth

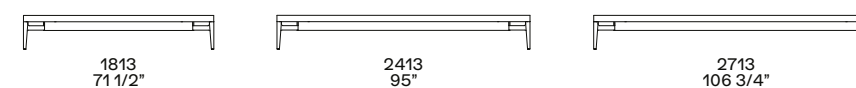

□ disponibile anche con anta ribalta  
also available with flap door

● luce a led interna opzionale  
optional inner led light

■ anta ribalta  
flap door

▲ anta complanare  
coplanar door

# FREE



Un monolite dalle forme stilizzate e geometriche alla Piet Mondrian da interpretare in libertà, scegliendo tra tutte le possibilità offerte dai colori laccati opachi e lucidi. In versione alta o bassa, la madia Free può essere attrezzata con accessori opzionali come il portaposate e il portabottiglie.

A monolith with stylized and geometric shapes in Piet Mondrian style to be freely interpreted, choosing from all the options offered by the mat and glossy lacquered colours. In high or low version, the sideboard Free can be equipped with optional accessories such as the cutlery holder and the bottle holder.



Nella pagina precedente: madia Free laccato opaco muschio. In questa pagina: madia Free laccato lucido visone. Sotto: dettaglio del portaposate estraibile in rovere spessart con piano e frontale rivestiti in cuoio 19 caffè.

Previous page: muschio mat lacquered Free sideboard. This page: visone glossy lacquered Free sideboard. Below: close up of the extractable cutlery tray in spessart oak with shelf and front covered in hide 19 caffè.









Nella pagina precedente: madia Free laccato lucido canapa con profilo maniglia in rovere spessart. In questa pagina: madia Free laccato opaco arena. Sotto: dettaglio del cassetto attrezzato con portabottiglie in rovere spessart.

Previous page: canapa glossy lacquered Free sideboard with handle profile in spessart oak. This page: arena mat lacquered Free sideboard. Below: close up of the drawer with bottle holder in spessart oak.

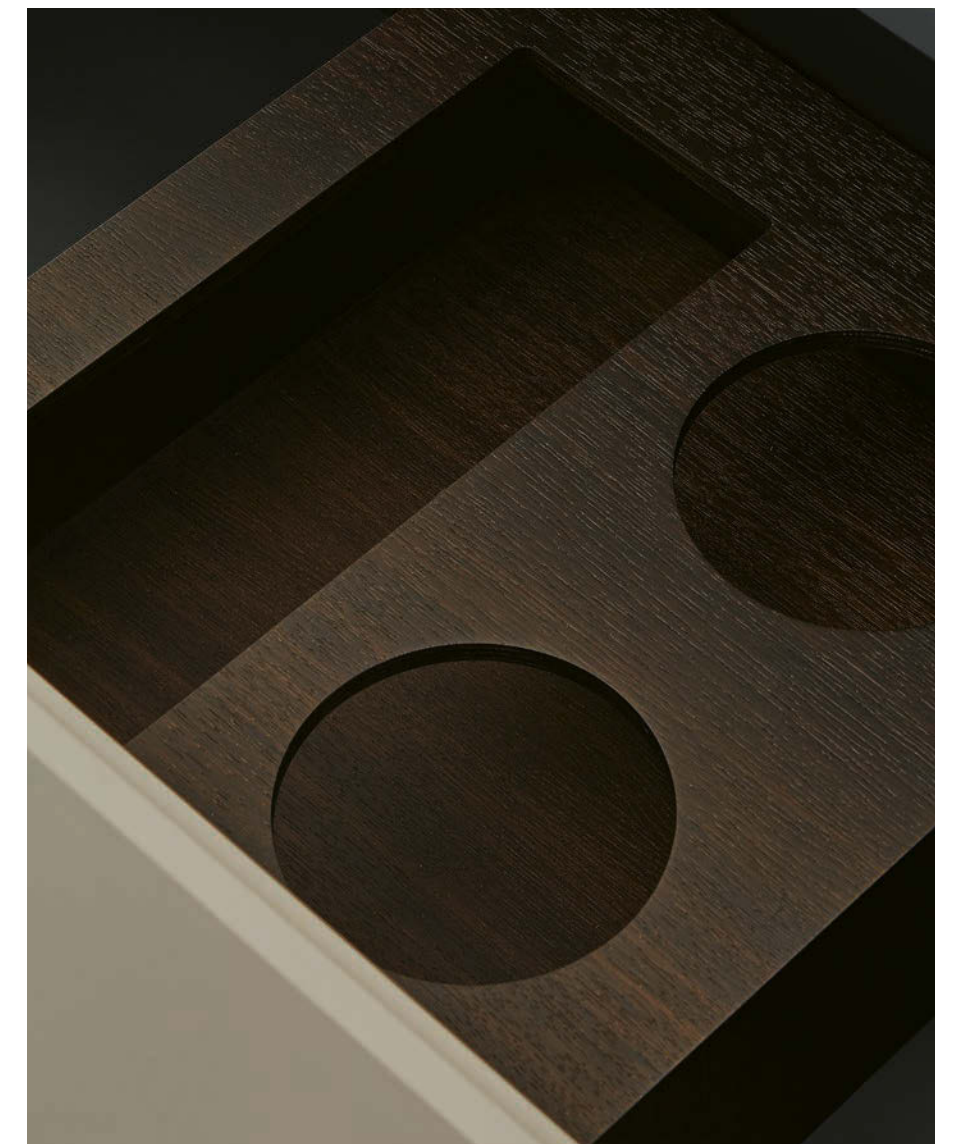



In questa pagina: madia Free laccato lucido ocra. Composizioni Wall System in rovere spessart e griglie interne laccato opaco moka. Pouf Onda in velluto non sfoderabile 1404 carbone. Tappeto Stripes. Nella pagina successiva: madia Free laccato lucido ocra con dettaglio del cassetto con attrezzatura in laccato opaco ardesia.

This page: ocra glossy lacquered Free sideboard. Wall System compositions in spessart oak and moka mat lacquered grids. Onda pouf in non-removable velvet 1404 carbone. Carpet Stripes. Next page: ocra glossy lacquered Free sideboard with close up of the drawer with equipment in ardesia mat lacquered.





## FREE

Design Carlo Colombo, 2008

Struttura e frontali in laccato opaco colori o laccato lucido colori. Interno struttura in laccato opaco colori con profilo maniglia in laccato opaco colori, noce gold o rovere spessart.

Attrezzature: ripiani nei vani con ante.

Attrezzature medie Free basse: un vassoio scorrevole asportabile in rovere spessart o noce gold, in appoggio in uno dei due vani interni dell'estrattore.

Attrezzature opzionali media Free bassa: portabottiglie in rovere spessart o noce gold, attrezzature per cassetto in laccato opaco ardesia con fondo cassetto in tecnocover Grain colori.

Attrezzature opzionali media Free alta: portaposate estraibile in rovere spessart o noce gold con piano e frontale rivestiti in cuoio 19 caffè.

Structure and fronts in mat lacquered colours or glossy lacquered colours. Inner structure in mat lacquered colours with handle profile in mat lacquered colours, gold walnut or spessart oak.

Equipment: shelves behind the doors.

Accessories sideboard Free, low version: one removable extractable tray in spessart oak or gold oak, in one of the two inner compartments of the pullout.

Optional accessories sideboard Free, low version: bottle holder in spessart oak or gold oak, equipment for drawers in ardesia mat lacquered with drawer bottom in tecnocover Grain in the available colours.

Optional accessories sideboard Free, high version: cutlery tray in spessart oak or gold oak with shelf and front covered in hide 19 caffè.

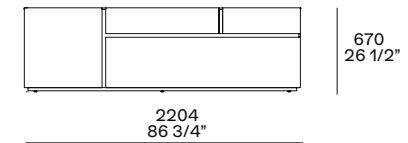

un'anta battente, due cassetti, un estrattore con due vani interni  
one leaf door, two drawers, one pullout with two inner compartments

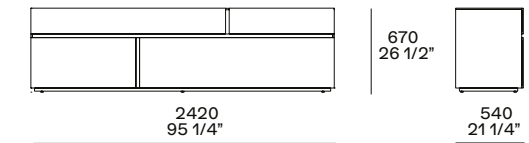

tre cassetti, un estrattore con due vani interni  
three drawers, one pullout with two inner compartments

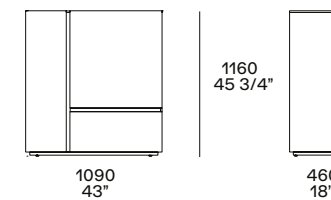

due ante battenti e un cassetto  
two leaf doors and one drawer



# PANDORA

Jean-Marie Massaud disegna una collezione di madie dall'aspetto contemporaneo e versatile. Quattro i modelli di Pandora, tutti caratterizzati dalla combinazione di ante e cassetti e dai particolari piedini in metallo. Pressoché infinite le possibilità estetiche, con struttura e ante da personalizzare scegliendo tra tutti i colori laccati opachi e lucidi e le diverse essenze.

Jean-Marie Massaud designs a collection of sideboards with a contemporary and versatile look. Four are the models of Pandora, all characterized by the combination of doors and drawers and by the particular metal feet. The aesthetic possibilities are nearly infinite, with customizable structure and doors with all the mat and glossy lacquered colours and the different woods.

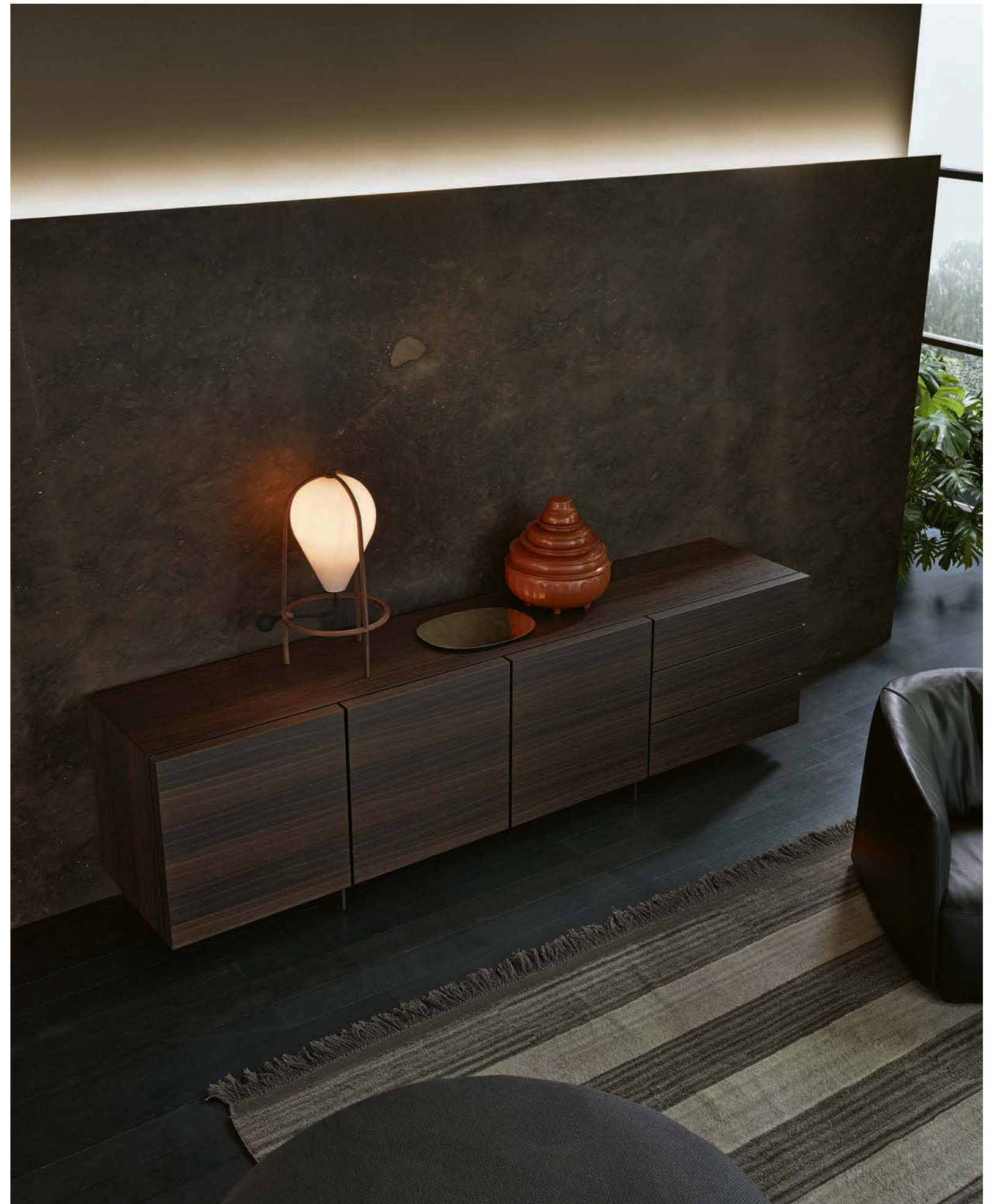





Nella pagina precedente: madia Pandora in rovere spessart con piedini in brown nickel opaco. Poltrona Santa Monica con rivestimento sfoderabile in pelle Special 14 nero. In questa pagina: madia Pandora in rovere spessart con piedini in brown nickel opaco.

Previous page: Pandora sideboard in spessart oak with mat brown nickel feet. Santa Monica armchair with removable cover in leather Special 14 nero. This page: Pandora sideboard in spessart oak with mat brown nickel feet.

In questa pagina: madia Pandora laccato bianco lucido con interno struttura laccato opaco roccia e piedini in brown nickel opaco. Nella pagina successiva: madia Pandora in olmo nero con interno struttura laccato opaco carbone e piedini in brown nickel lucido.

This page: bianco glossy lacquered Pandora sideboard, roccia mat lacquered inner structure and mat brown nickel feet. Next page: Pandora sideboard in black elm with carbone mat lacquered inner structure and glossy brown nickel feet.









In questa pagina: madia Pandora in rovere spessart con ante e cassetti laccato lucido visone e piedini in brown nickel lucido. Interno struttura laccato opaco visone. Sotto: dettaglio del cassetto con attrezzatura opzionale in laccato opaco ardesia e fondo in tecnocover Grain 05 latte. Nella pagina successiva: madia Pandora in rovere spessart con interno struttura laccato opaco muschio.

This page: Pandora sideboard in spessart oak with visone glossy lacquered doors and drawers, feet in glossy brown nickel. Visone mat lacquered inner structure. Below: close up of the drawer with optional equipment in ardesia mat lacquered and drawer bottom in tecnocover Grain 05 latte. Next page: Pandora sideboard in spessart oak with muschio mat lacquered inner structure.





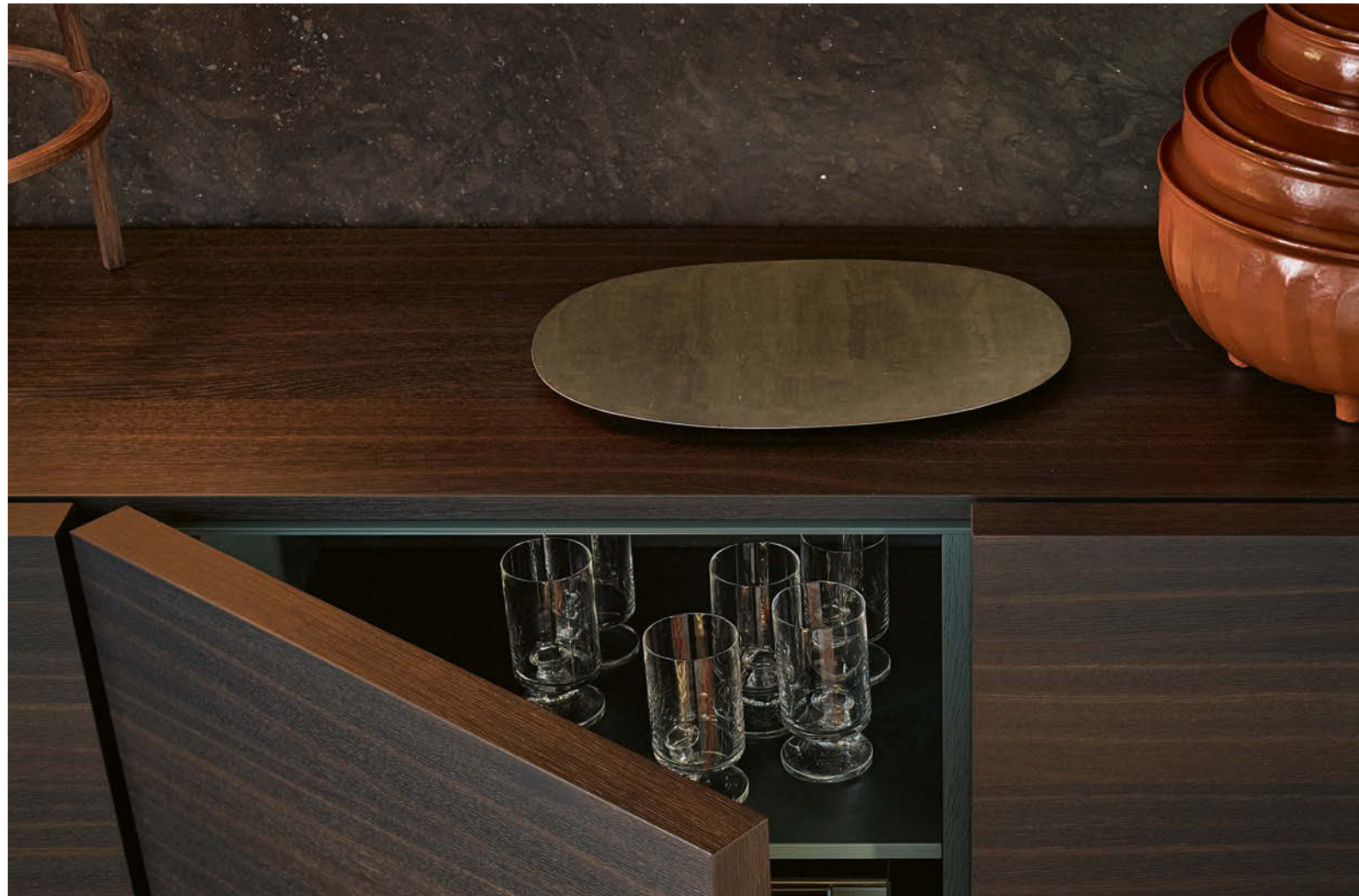

**PANDORA**  
Design Jean-Marie Massaud, 2012

Struttura esterna e frontali laccato opaco colori, laccato lucido colori, rovere spessart o olmo nero. La struttura può avere una finitura diversa dai frontali.  
 Interno struttura in laccato opaco colori.  
 Piedini in metallo verniciato brown nickel opaco o lucido.  
 Attrezzature: ripiani nei vani con ante.  
 Attrezzature opzionali medie Pandora basse: attrezzature per cassetto in laccato opaco ardesia con fondo cassetto in tecnocover Grain colori.

External structure and fronts mat lacquered colours, glossy lacquered colours, spessart oak or black elm.  
 The structure can be in a different finish than the fronts. Inner structure in mat lacquered colours. Feet in mat or glossy brown nickel painted metal.  
 Equipment: shelves behind the doors.  
 Optional equipment for low Pandora sideboard: equipment for drawer in ardesia mat lacquered, drawer bottom in tecnocover Grain in the available colours.

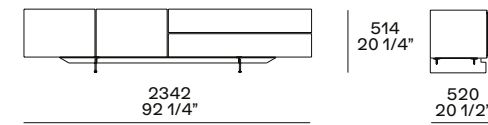

due ante battenti e due cassetti  
two leaf doors and two drawers

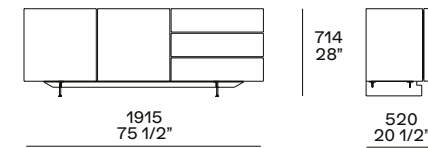

due ante battenti e tre cassetti  
two leaf doors and three drawers

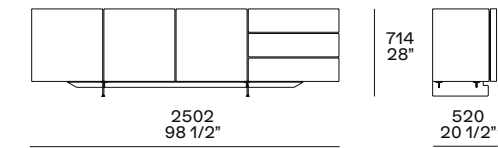

tre ante battenti e tre cassetti  
three leaf doors and three drawers

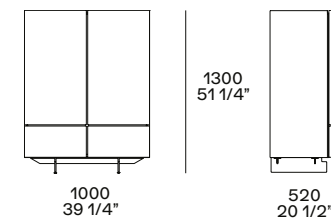

due ante battenti e due cassetti  
two leaf doors and two drawers

# BRISTOL SYSTEM



Bristol System è una collezione di complementi che si sviluppa a partire da un modulo contenitore attrezzabile con cassetti, vani a giorno e vani chiusi da un'anta a ribalta. Un sistema ideale per la zona giorno, da usare sia a parete sia a centro stanza.

Bristol System is a collection of complements that develops from a storage module that can be equipped with drawers, open compartments, and compartments closed by a flap door. An ideal system for the day area, to be used either at the wall or in the middle of the room.









Nella pagina introduttiva: madia Bristol in rovere spessart, inserti e piedini in brown nickel opaco, vani a giorno e contenitori laccato opaco carbone. Nella pagina precedente: madie Bristol laccato opaco visone, inserti e piedini in brown nickel opaco e contenitori in rovere spessart. Qui e nella pagina successiva: madia Bristol in olmo nero, inserti e piedini in brown nickel lucido, contenitore in olmo nero.

Introduction page: Bristol sideboard in spessart oak, inlays and feet in mat brown nickel, carbone mat lacquered open compartments and storage units. Previous page: visone mat lacquered Bristol sideboards, inlays and feet in mat brown nickel and storage units in spessart oak. This and next page: Bristol sideboard in black elm, inlays and feet in glossy brown nickel, storage unit in black elm.

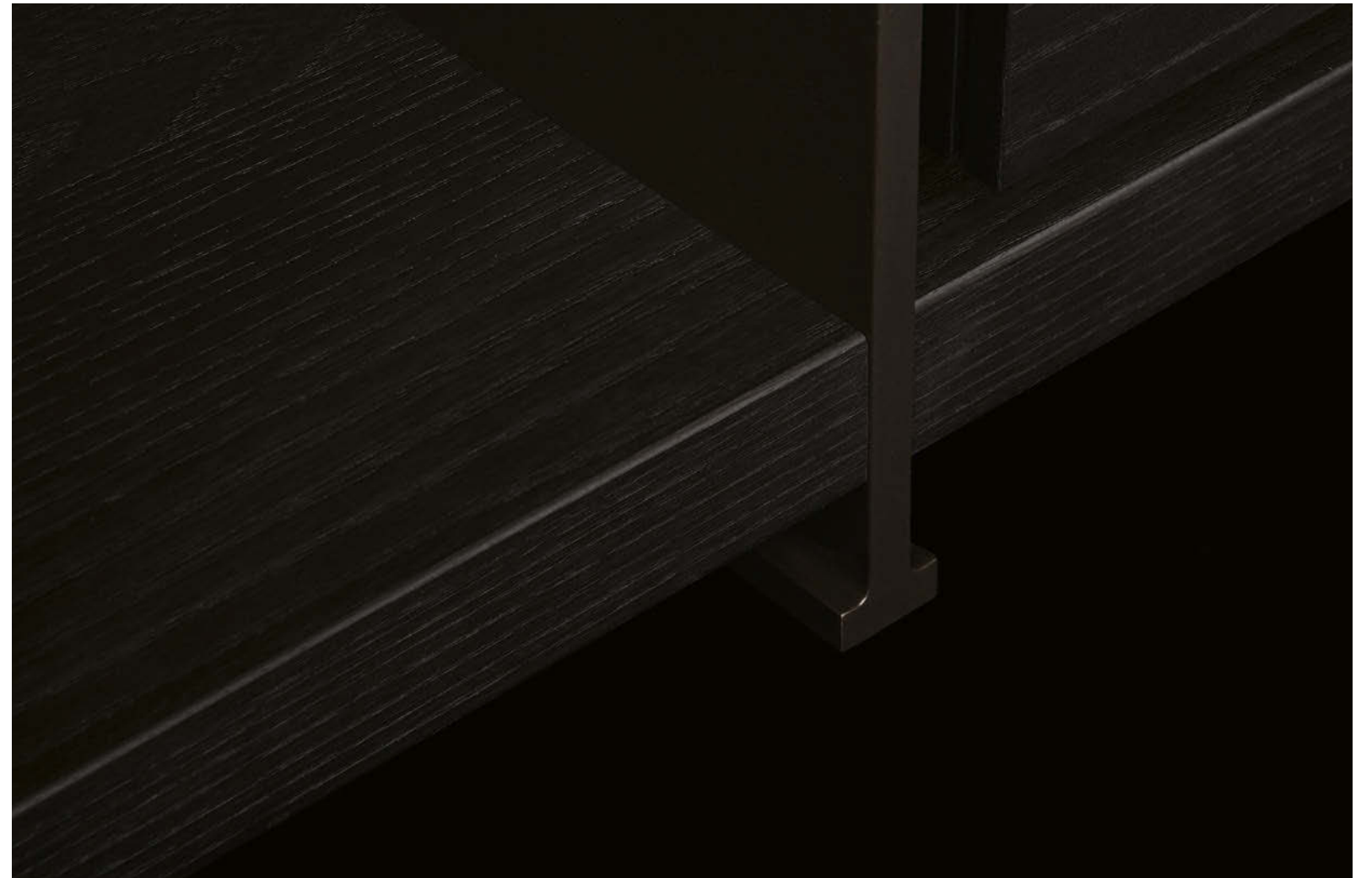







A sinistra: madia Bristol in rovere spessart, inserti e piedini in brown nickel opaco, vani a giorno e contenitori laccato opaco piombo. Divano Bristol in tessuto sfoderabile Rabat 412 cemento e cuscino in velluto Persia 1403 ocra, tavolini retrodivano Bristol in rovere spessart. Sotto: dettaglio del top della madia Bristol attrezzato con canalina passacavi.

Left: Bristol sideboard in spessart oak, inlays and feet in mat brown nickel, piombo mat lacquered open compartments and storage units. Bristol sofa in removable fabric Rabat 412 cemento and cushion in velvet Persia 1403 ocra, Bristol small tables to the back of the sofa in spessart oak. Below: close up of the top of Bristol sideboard arranged with cable passage.

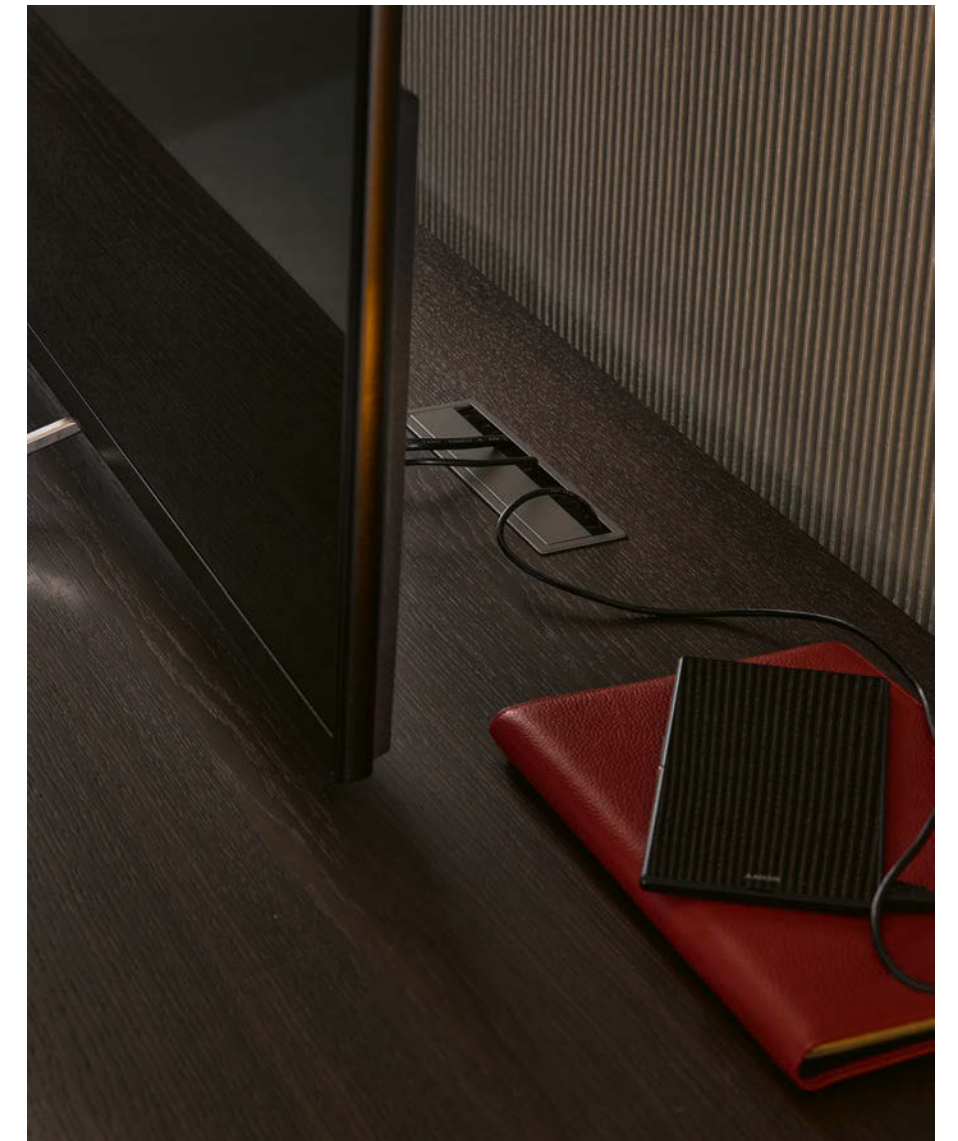

## BRISTOL SYSTEM

Design Jean-Marie Massaud, 2013

Serie di madie disponibili in due altezze e attrezzabili con una serie di contenitori. Struttura in laccato opaco colori, rovere spessart o olmo nero. Inserti e piedini in alluminio verniciato brown nickel opaco o lucido. Contenitori in laccato opaco colori, rovere spessart o olmo nero.

Le madie possono essere predisposte con tappi o canaline passacavi e ripetitore di telecomandi inseribile nei contenitori con anta a ribalta.

Series of sideboards available in two heights accessorized with several storage units. Structure available in mat lacquered colours, spessart oak or black elm. Inlays and feet in mat or glossy brown nickel painted aluminium. Storage units available in mat lacquered colours, spessart oak or black elm.

The sideboards can be arranged with cable passage and relay for remote controls to be mounted in the storage units with flap door.

### Madie con vani a giorno attrezzabili Sideboards with open compartments to be accessorised

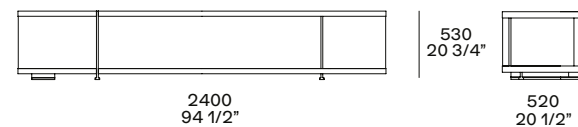
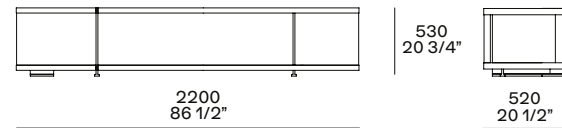
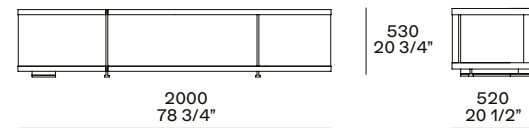

### Contenitori Storage units

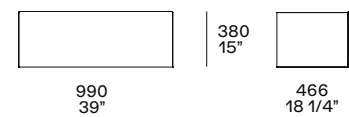

anta a ribalta con ripiano interno o cassetto con vassoio estraibile  
flap door with inner shelf or drawer with extractable tray

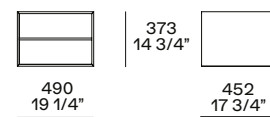

contenitore a giorno  
open storage unit

### Madie con vani a giorno attrezzabili sx Sideboards with open compartments to be accessorised left

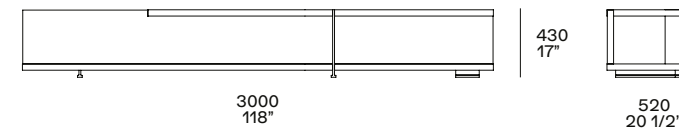

### Madie con vani a giorno attrezzabili dx Sideboards with open compartments to be accessorised right

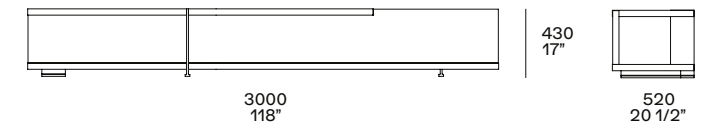

### Madie con vani a giorno attrezzabili Sideboards with open compartments to be accessorised

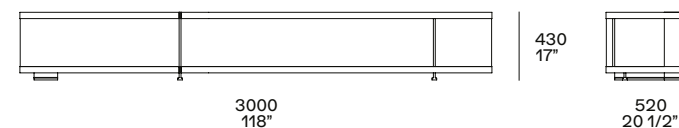

### Contenitori Storage units



anta a ribalta o cassetto  
flap door or drawer



anta a ribalta o cassetto  
flap door or drawer



In questa pagina: libreria Bristol in rovere spessart, montanti verticali, inserti e piedini in metallo verniciato brown nickel opaco.

This page: Bristol bookcase in spessart oak, vertical uprights, inlays and feet in mat brown nickel painted metal.



In questa pagina: libreria Bristol in laccato opaco roccia, montanti verticali, inserti e piedini in metallo verniciato brown nickel lucido.

This page: Bristol bookcase in mat lacquered roccia, vertical uprights, inlays and feet in glossy brown nickel painted metal.





In questa pagina: libreria Bristol in olmo nero, montanti verticali, inserti e piedini in metallo verniciato brown nickel opaco, contenitore con anta a ribalta in olmo nero.

This page: Bristol bookcase in spessart oak, vertical uprights, inlays and feet in mat brown nickel painted metal, storage units in black elm with flap door.



## BRISTOL SYSTEM

Design Jean-Marie Massaud, 2015

Collezione di librerie disponibili in quattro larghezze e tre altezze con la possibilità di inserire in alcuni vani una serie di contenitori. Struttura librerie in laccato opaco colori, rovere spessart o olmo nero. Montanti verticali, inserti e piedini in alluminio verniciato brown nickel opaco o lucido. Contenitori in laccato opaco colori, rovere spessart o olmo nero.

Collection of bookcases available in four widths and three heights with the possibility of inserting storage units in the open compartments. Bookcase structure in mat lacquered colours, spessart oak or black elm. Vertical uprights, inlays and feet in mat or glossy brown nickel painted aluminium. Storage units in mat lacquered colours, spessart oak or black elm.

### Librerie h 775 Bookcases h 30 1/2"

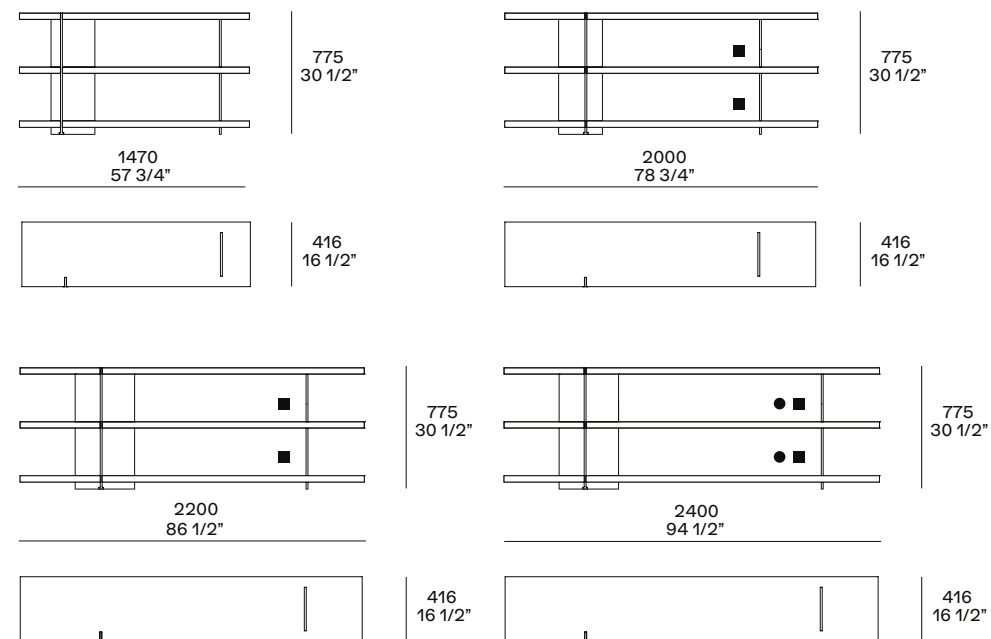

### Contenitori Storage units

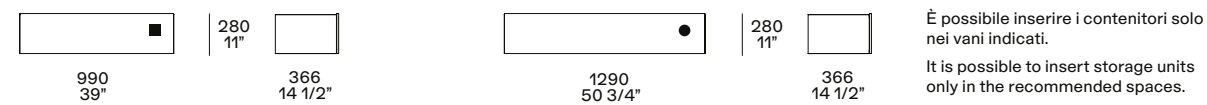

anta a ribalta o cassetto  
flap door or drawer

anta a ribalta o cassetto  
flap door or drawer

È possibile inserire i contenitori solo nei vani indicati.  
It is possible to insert storage units only in the recommended spaces.

### Librerie h 1120 Bookcases h 44"

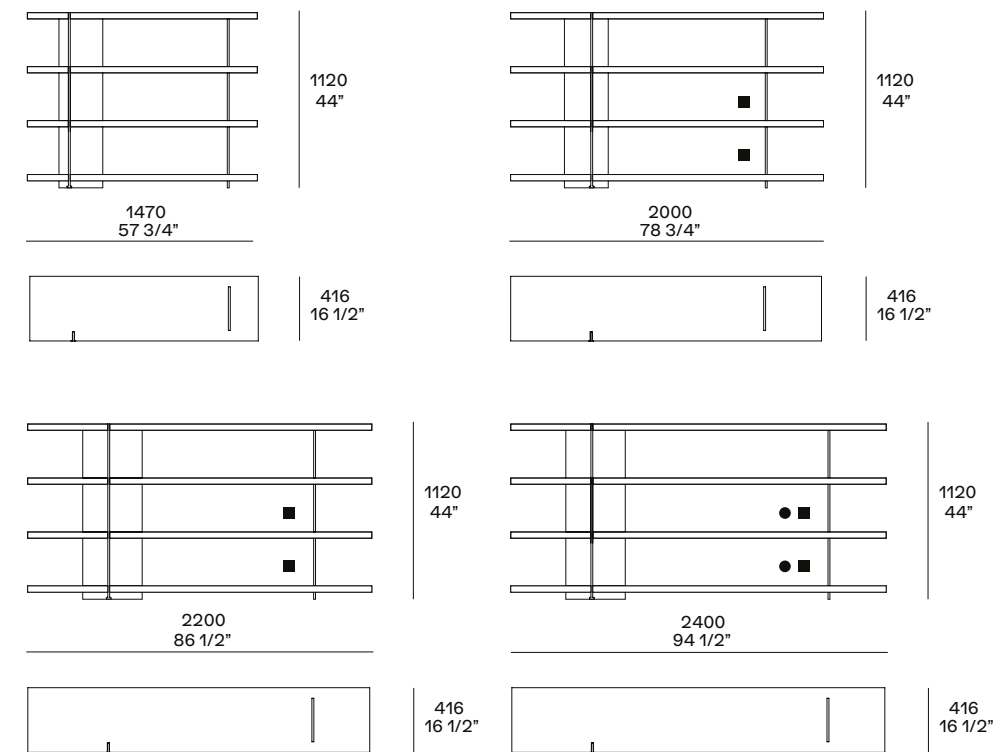

### Librerie h 1465 Bookcases h 57 3/4"

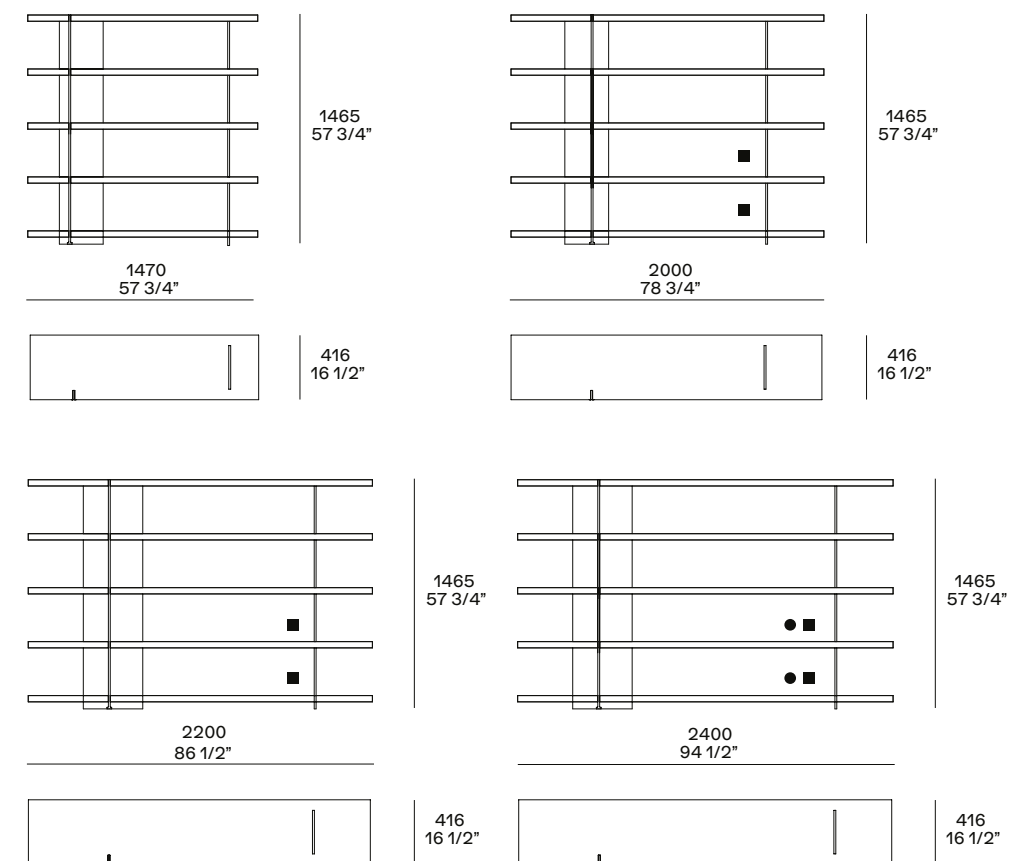



TECHNICAL DATA

TAPPETI  
CARPETS

474

FINITURE  
FINISHINGS

480

INDICE PRODOTTI  
PRODUCT INDEX

488

## TAPPETI CARPETS

### Relief

Prodotto a mano con tecnica handloom.  
Trama in cotone, vello in lana himalayana  
e seta di bambù, bouclé in lana himalayana.  
Dimensioni mm: rettangolare 1700x2400  
2300x3000 - 3000x4000  
quadrato 3000x3000.

Handmade with the handloom technique.  
Cotton weave, fleece in Hymalayan wool  
and bamboo silk, Hymalayan wool bouclé.  
Dimensions in: rectangular 67"x94 1/2"  
90 1/2"x118" - 118"x157 1/2"  
square 118"x118".



Perla



Cammello

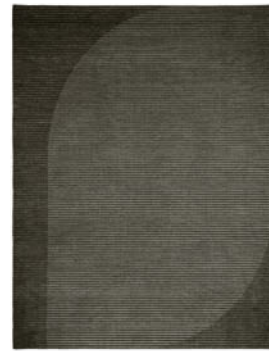

Tortora

### Cannelé

Prodotto a mano con tecnica handloom.  
Trama in cotone, vello in lana himalayana  
e seta di bambù, bouclé in lana himalayana.  
Dimensioni mm: rettangolare 1700x2400  
2300x3000 - 3000x4000  
quadrato 3000x3000.

Handmade with the handloom technique.  
Cotton weave, fleece in Hymalayan wool  
and bamboo silk, Hymalayan wool bouclé.  
Dimensions in: rectangular 67"x94 1/2"  
90 1/2"x118" - 118"x157 1/2"  
square 118"x118".



### Tratto

Prodotto a mano con tecnica handloom.  
Trama in cotone, vello in lana himalayana  
e seta di bambù.  
Dimensioni mm: rettangolare 1700x2400  
2300x3000 - 3000x4000  
quadrato 3000x3000.

Handmade with the handloom technique.  
Cotton weave, fleece in Hymalayan wool  
and bamboo silk.  
Dimensions in: rectangular 67"x94 1/2"  
90 1/2"x118" - 118"x157 1/2"  
square 118"x118".

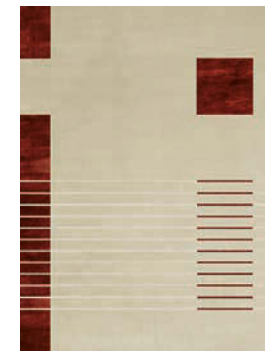

Ruggine



Carbone

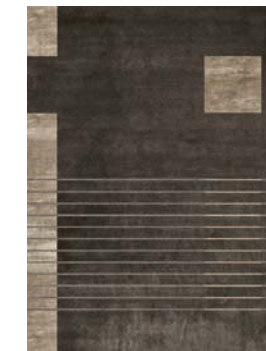

Tortora



TAPPETI  
CARPETS

**Frame**

Prodotto a mano con tecnica handloom.  
Trama in cotone, vello in seta di bambù.  
Bordo perimetrale di 80 mm in lana  
himalayana in tinta solo per la versione  
rettangolare.  
Dimensioni mm: rettangolare 1700x2400  
2300x3000 - 3000x4000  
quadrato 3000x3000 - ovale 2300x4000.

Handmade with the handloom technique.  
Cotton weave, fleece in bamboo silk.  
80 mm - 3 1/4" perimeter edge in Himalayan  
wool in matching color only for the  
rectangular version.  
Dimensions inches: rectangular 67"x94 1/2"  
90 1/2"x118" - 118"x157 1/2"  
square 118"x118" - oval 90 1/2"x157 1/2".



Grey



Gold



Perla



Carbone



**Plain**

Prodotto a mano con tecnica handloom.  
Trama in cotone, vello in aloe e seta di bambù.  
Nella versione rettangolare fascia di  
150 mm in tonalità più scura sul lato superiore  
e inferiore e di 100 mm per la dimensione  
1700x2400. Nella versione tonda la parte più  
scura è di 1/4 del tappeto.  
Dimensioni mm: rettangolare 1700x2400  
2300x3000 - 3000x4000  
quadrato 3000x3000 - rotondo Ø 2500.

Handmade with the handloom technique.  
Cotton weave, fleece in aloe and bamboo silk.  
Rectangular version 6" band in darker colour  
in the upper and lower side and 4" band for  
the size 67"x94 1/2".  
In the round version the darkest part is  
1/4 of the carpet.  
Dimensions inches: rectangular 67"x94 1/2"  
90 1/2"x118" - 118"x157 1/2"  
square 118"x118" - round Ø 94 1/2".



Tortora

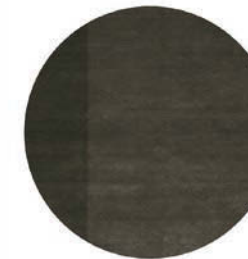

Cipria

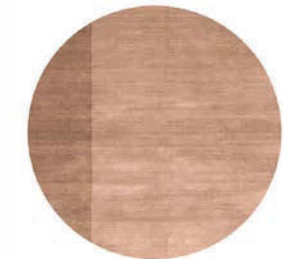

Ruggine



Arena

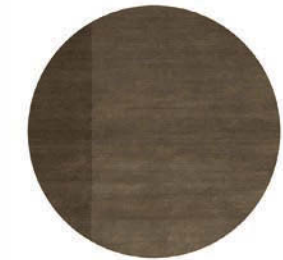

Natural



## TAPPETI CARPETS

### Dama

Prodotto a mano con tecnica handloom.  
Trama in cotone, vello in lana himalayana e seta di bambù.  
Dimensioni mm: rettangolare 1100×3500  
1700×2400 - 2300×3000 - 3000×4000  
quadrato 3000×3000.

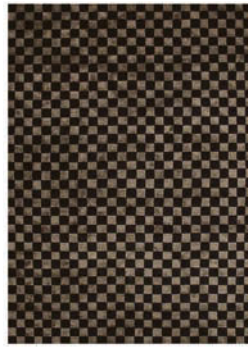

Handmade with the handloom technique.  
Cotton weave, fleece in Hymalayan wool and bamboo silk.  
Dimensions inches: rectangular 43 1/4"x137 1/4" - 67"x94 1/2" - 90 1/2"x118" - 118"x157 1/2" square 118"x118".

### Stripes

Prodotto a mano con tecnica handloom.  
Trama in cotone, vello in lana himalayana e seta di bambù.  
Dimensioni mm: rettangolare 1100×3500  
1700×2400 - 2300×3000 - 3000×4000  
quadrato 3000×3000.



Handmade with the handloom technique.  
Cotton weave, fleece in Hymalayan wool and bamboo silk.  
Dimensions inches: rectangular 43 1/4"x137 1/4" - 67"x94 1/2" - 90 1/2"x118" - 118"x157 1/2" square 118"x118".

### Soft

Prodotto a mano con tecnica handloom.  
Trama in cotone, vello in seta di bambù grigio sfumato.  
Dimensioni mm: rettangolare 1700×2400  
2300×3000 - 3000×4000  
quadrato 3000×3000.



Handmade with the handloom technique.  
Cotton weave, fleece in bamboo silk shaded grey.  
Dimensions inches: rectangular 67"x94 1/2" - 90 1/2"x118" - 118"x157 1/2" square 118"x118".



FINITURE  
FINISHINGS

**Laccato opaco**  
**Mat lacquer**

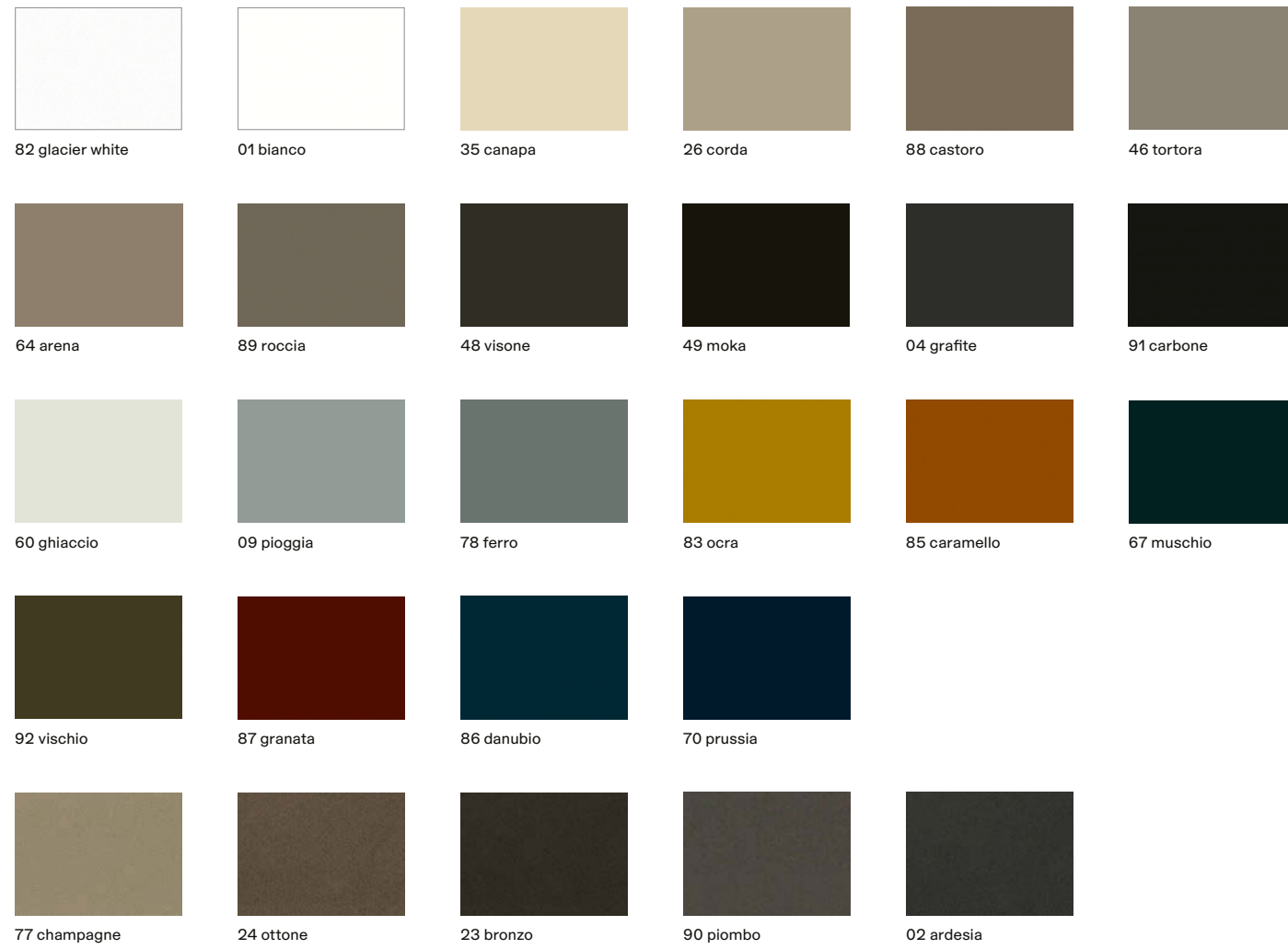

**Laccato lucido**  
**Glossy lacquer**



**Laccato antigraffio**  
**Antiscratch lacquer**

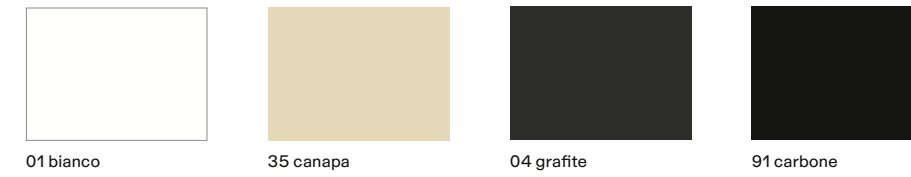

**Laccato metallico**  
**Metallic lacquer**



FINITURE  
FINISHINGS

**Essenza  
Wood**



rovere gold  
gold oak



rovere spessart  
spessart oak



noce gold  
gold walnut



olmo nero  
black elm



massello noce canaletto  
solid walnut canaletto



cedro  
cedar



noce  
walnut

**Cuoio  
Hide**



28 avorio

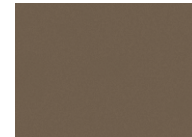

29 tortora

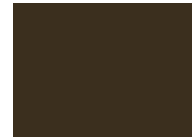

19 caffè

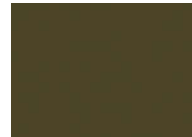

38 oliva

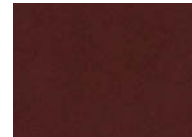

15 prugna



26 invecchiato



03 grigio scuro

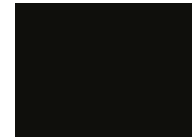

02 nero

**Tecnocover Grain  
Grain tecnocover**



05 latte

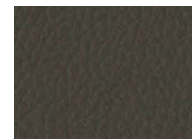

01 elefante



02 moro



06 nocciola

**Tessuto  
Fabric**



lino chiaro



lino é cru



lino bruciato



lino scuro

**Marmo levigato  
Mat marble**



bianco carrara



calacatta oro



verde lepanto

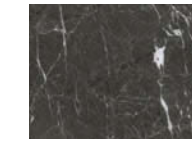

grigio stardust

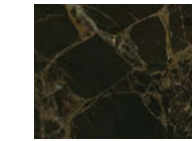

emperador dark



sahara noir  
finitura poliestere  
polyester finish



zecevo

**Marmo lucido  
Glossy marble**



bianco carrara



calacatta oro



verde lepanto



grigio stardust



emperador dark



sahara noir  
finitura poliestere  
polyester finish



noir saint laurent

**Gabbro  
Gabbro**



nero assoluto  
texture juta

**Onice  
Onyx**



ambra  
amber

**Semiprezioso  
Semiprecious stone**

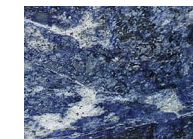

lapislazzulo blu  
blue lapis lazuli

**Pietra spatolata  
Spatula-finish stone**



ebano  
ebony

**Grès porcellanato lucido  
Glossy gres porcelain**



emperador dark



calacatta oro



sahara noir



FINITURE  
FINISHINGS

**Tessuti  
Fabrics**

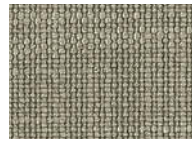

atlanta cat. b  
12 colori - colours



caleo cat. b  
15 colori - colours



chios cat. b  
13 colori - colours



eraclea cat. b  
12 colori - colours

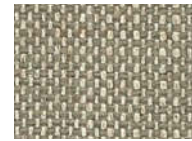

aspen cat. c  
12 colori - colours

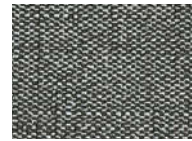

lima cat. c  
11 colori - colours



siviglia cat. c  
14 colori - colours



antea cat. d  
13 colori - colours



cordoba cat. d  
13 colori - colours



corinto cat. d  
5 colori - colours



indra cat. d  
12 colori - colours



itaca cat. d  
10 colori - colours

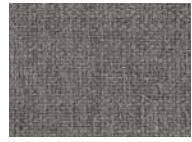

kushiro cat. d  
13 colori - colours



lipsi cat. d  
11 colori - colours



micene cat. d  
9 colori - colours



milos cat. d  
5 colori - colours

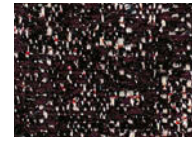

olimpia cat. d  
14 colori - colours



oxford cat. d  
8 colori - colours



rabat cat. d  
10 colori - colours



sendai cat. d  
5 colori - colours



sparta cat. d  
12 colori - colours



agadir cat. e  
9 colori - colours



arcadia cat. e  
12 colori - colours



argo cat. e  
13 colori - colours



hannover cat. e  
11 colori - colours

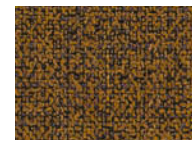

kitami cat. e  
12 colori - colours



naxos cat. e  
11 colori - colours



nayoro cat. e  
10 colori - colours



orleans cat. e  
10 colori - colours



persia cat. e  
16 colori - colours

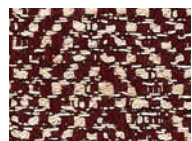

skyros cat. e  
12 colori - colours



zante cat. e  
11 colori - colours



brest cat. g  
10 colori - colours



dundee cat. g  
6 colori - colours



glasgow cat. g  
6 colori - colours



lero cat. g  
2 colori - colours



nancy cat. g  
6 colori - colours



norwich cat. g  
8 colori - colours



sheffield cat. g  
9 colori - colours



siro cat. g  
4 colori - colours



tebe cat. g  
11 colori - colours

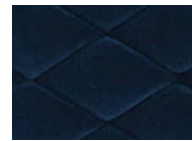

gibson cat. z  
6 colori - colours

**Pelle  
Leather**



spring cat. p  
13 colori - colours



colors cat. s  
25 colori - colours

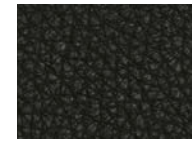

silk cat. s  
13 colori - colours



silk intrecciata cat. s  
woven leather silk  
13 colori - colours



deep cat. x  
10 colori - colours



special cat. x  
21 colori - colours



nabuk cat. y  
10 colori - colours



nabuk intrecciata cat. y  
woven leather nabuk  
10 colori - colours



invecchiata cat. y  
6 colori - colours



soft cat. y  
14 colori - colours

**Pelliccia Cashmere  
Cashmere fur**



bianco



grigio



nero



bianco/nero



cappuccino



nero

**Pelle Hairy  
Hairy leather**

**Tecnocover Pixel  
Pixel tecnocover**

**Bordura gros-grain - bordura in seta - filati  
Grosgrain border - silk border - yarns**



burro



perla



sahara



rubino

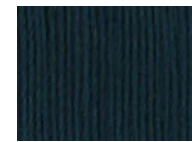

tempesta  
escluso bordura in seta  
except silk border



navy



acciaio



nero

**Provence coordinati letto  
Bed linen Provence**



01 bianco



02 panna



08 polvere



04 tortora



06 roccia



07 grafite

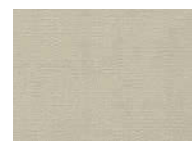

03 ghiaccio



FINITURE  
FINISHINGS

**Vetro  
Glass**



1000 trasparente  
transparent

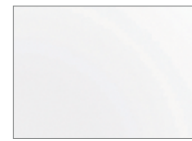

2000 trasparente  
extrachiaro-transparent  
extralight



3051 bronzato  
bronzed



3050 fumé



2700 line

**Vetro riflettente  
Reflecting glass**



5000 trasparente  
transparent



5010 blu



5051 bronzato  
bronzed



5059 fumé

**Vetro acidato  
Etched glass**



5380 acciaio



5323 bronzo



5325 titanio



**Specchio  
Mirror**

4000 bianco  
white



4051 bronzato  
bronzed

**Vetro satinato  
Mat glass**



2301 bianco extrachiaro  
extralight bianco

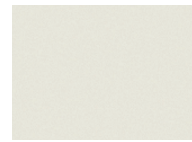

2373 ghiaccio  
ghiaccio



1335 canapa



1364 arena



1304 grafite



1303 nero

**Vetro lucido  
Glossy glass**

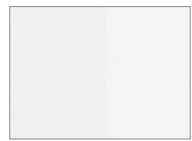

2201 bianco extrachiaro  
extralight bianco



2273 ghiaccio



1235 canapa



1264 arena



1204 grafite



1203 nero



1259 bordeaux

**Nobilitato  
Melamine**



olmo  
elm



noce c.  
walnut c.



rovere cenere  
cenere oak



rovere spessart  
spessart oak



canvas beige



canvas grigio



graffiti 01 bianco



graffiti 35 canapa



graffiti 60 ghiaccio



silk canapa



silk grey



silk bronzo



club 01 bianco



skin  
27 colori laccato opaco  
27 mat lacquered colours



skin 94 latte  
laccato opaco  
mat lacquered



skin 97 elefante  
laccato opaco  
mat lacquered



skin 93 moro  
laccato opaco  
mat lacquered



skin 98 nocciola  
laccato opaco  
mat lacquered

**Nobilitato interno cassetti  
Melamine drawers structure**

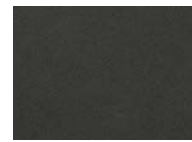

ardesia



madras  
Quid sistema giorno -  
day system



roller latte

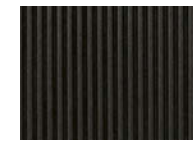

roller ardesia

**Metacrilato  
Methacrylate**

**Parti metalliche  
Metal parts**



brown nickel opaco  
mat brown nickel



brown nickel lucido  
glossy brown nickel



brown nickel satinato  
brushed brown nickel



champagne opaco  
mat champagne



champagne satinato  
brushed champagne



ardesia opaco  
mat ardesia



cromo satinato  
brushed chrome



cromo nero lucido  
black chrome



cromo nero satinato  
brushed black chrome

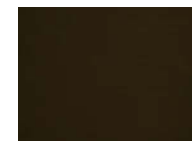

bronzato  
bronzed



bronzo anticato  
antique bronze

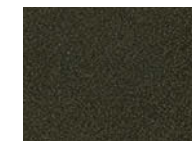

brunito opaco  
mat brunito



spatolato ferro  
spatula-finish ferro



spatolato bronzo  
spatula-finish bronzo



oro lucido  
glossy gold



alluminio brill  
aluminium brill



SEDIE  
CHAIRS



Sophie Lite, design Emmanuel Gallina  
pp. 10-21



Sophie, design Emmanuel Gallina  
pp. 22-33



Stanford Bridge, design Jean-Marie Massaud  
pp. 34-45



Grace, design Emmanuel Gallina  
pp. 46-59



Ventura, design Jean-Marie Massaud  
pp. 60-69



Ventura, design Jean-Marie Massaud  
pp. 70-73



Seattle, design Jean-Marie Massaud  
pp. 74-85



Ipanema, design Jean-Marie Massaud  
pp. 86-97



Manta, design Rodrigo Torres  
pp. 98-107



Guest, design Rodolfo Dordoni  
pp. 108-115

PANCHE  
BENCHES



Jane, design Emmanuel Gallina  
pp. 120-127



Home Hotel, design Jean-Marie Massaud  
pp. 128-139

SGABELLI  
STOOLS



Seattle, design Jean-Marie Massaud  
pp. 144-153



Sophie Lite, design Emmanuel Gallina  
pp. 154-163



Ventura, design Jean-Marie Massaud  
pp. 164-173



Ics, design Rodrigo Torres  
pp. 174-181

TAVOLI  
TABLES



Mondrian, design Jean-Marie Massaud  
pp. 186-201



Henry, design Emmanuel Gallina  
pp. 202-217



Concorde, design Emmanuel Gallina  
pp. 218-237



Kensington, design Jean-Marie Massaud  
pp. 238-255



Home Hotel, design Jean-Marie Massaud  
pp. 256-275



Flute, design Roberto Barbieri  
pp. 276-285



Howard, design Jean-Marie Massaud  
pp. 286-297



Blade, design R&D Poliform  
pp. 298-309



Trevi, design Roberto Barbieri  
pp. 310-317

SCRITTOI  
DESKS



Concorde, design Emmanuel Gallina  
pp. 322-329



Mathieu, design Emmanuel Gallina  
pp. 330-337



Home Hotel, design Jean-Marie Massaud  
pp. 338-343, 349

CONSOLLE  
CONSOLE



Home Hotel, design Jean-Marie Massaud  
pp. 344-349

MADIE  
SIDEBOARDS



Symphony, design Emmanuel Gallina  
pp. 354-383



Code, design R&D Poliform  
pp. 384-421



Free, design Carlo Colombo  
pp. 422-435



Pandora, design Jean-Marie Massaud  
pp. 436-449



Bristol System, design Jean-Marie Massaud  
pp. 450-463

LIBRERIE  
BOOKCASES

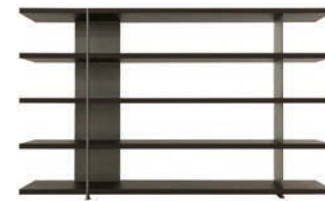

Bristol System, design Jean-Marie Massaud  
pp. 464-471



**Poliform Spa**  
via Montesanto 28  
Casella postale n. 1  
22044 Inverigo (CO) Italy  
t +39 031 6951  
f +39 031 699444  
info@poliform.it  
poliform.it



2018 Adi Compasso D'oro  
Career Award

**Poliform realizza tutte le sue collezioni in Italia usando componenti e materie prime selezionate.**

**All the Poliform collections are manufactured 100% in Italy using top-class components and materials.**

Poliform si riserva il diritto di apportare, senza preavviso, ogni modifica mirata al miglioramento funzionale e qualitativo dei propri prodotti. Testi e disegni presenti in questo stampato hanno scopo divulgativo: per ogni aspetto tecnico e dimensionale fare riferimento ai listini aziendali e relativi aggiornamenti. I campioni di colori e materiali hanno valore indicativo.

Poliform reserves the rights at all time to apply modifications for the functional or qualitative improvement of its products. Texts and drawings present in this brochure have a divulgative purpose: for every technical and dimensional aspect please refer to the company's price lists and their relative updatings. The colour and material samples have an indicative value.

**Creative Direction**  
Apartamento Studios

**Graphic Design**  
Apartamento Studios

**Interiors Photography**  
Federico Cedrone, Omar Sartor

**Still Life Photography**  
Silvia Orlandi

**Interiors Styling**  
Poliform Lab

1st edition January 2022  
cod. 123/R1/2022







POLIFORM.COM